



**INSTRUMENTAL  
VETERINARIO Y GANADERO**

**INSEMINACIÓN ARTIFICIAL  
PORCINA, CUNÍCOLA Y VACUNA**

**VETERINARY  
AND LIVESTOCK INSTRUMENTS**

**PORCINE, RABBIT AND CATTLE  
ARTIFICIAL INSEMINATION**



**diseño  
design**



**tecnología  
technology**



**desarrollo  
development**







**INSERBO** nace el año 1992 con una clara vocación de servicio integral en el mundo del instrumental veterinario y material ganadero.

Integrado por un equipo de profesionales con más de 35 años de experiencia en el sector, siempre se ha caracterizado por la fabricación, innovación, investigación, desarrollo, distribución y promoción de una seleccionada línea de productos de primera calidad, con más de 6.000 productos en nuestro catálogo compuesto de instrumental veterinario, material ganadero e inseminación artificial para vacuno, porcino y conejos.

Este reconocimiento y el afán de dar cada día un mayor servicio nos ha permitido expandirnos a escala nacional e internacional y disponer de unas nuevas instalaciones con más de 6.000 m<sup>2</sup>, en las cuales se ubican oficinas, talleres de fabricación, laboratorio de contrastación seminal, almacenes y talleres de servicio técnico. Disponemos además de Departamento de Investigación y Desarrollo, Departamento Técnico y de Asesoramiento.

**INSERBO** cuenta con maquinaria propia de última generación para la fabricación de nuestros productos. Actualmente fabricamos muchos de los productos que comercializamos. **INSERFIX**, **STARVET**, **GLASSGEN**, **FUTURE-1**, **SERBONET** y **GROTEERMAN**, marcas registradas por **INSERBO SL**, se utilizan para la denominación de la mayoría de productos que fabricamos, así como diversas patentes en nuestro haber.

En este catálogo que tienen en sus manos podrán encontrar de manera fácil y ordenada todos los productos necesarios para el desarrollo diario de las granjas y el instrumental adecuado para los veterinarios, con la garantía de la máxima calidad.

***INSERBO** came into being in 1992 with the intention of offering a complete service in the sector of veterinary instruments and equipment for stock.*

*Inserbo, formed by a professional group of people, with more than 25 years of experience in the sector, has always been characterised by the production, innovation, investigation, development, distribution and promotion of a selected line of more than 6,000 first quality products, our catalogue consists of veterinary and breeding products and artificial insemination of cattle, pigs and rabbits.*

*This recognition and the every day effort to offer a better service, have made possible our growth into the national and international market our new facilities with more than 6,000 m<sup>2</sup> consist of the office, the production workshop, the laboratory of seminal contrasting, the storehouse and the technical service workshop are located.*

*Moreover, we have an Investigation and Development Department, a Technical Department and an Advice Department in order to give further assistance.*

***INSERBO** owns latest generation machinery for the production process. At present, we produce many of the items we distribute, **INSERFIX**, **STARVET**, **GLASSGEN**, **FUTURE-1**, **SERBONET** and **GROTEERMAN**, are the registered trademarks we use for naming the majority of items we produce, as several patents of our own.*

*In this catalogue you are holding, you will find, in an easy and clear way and with the best quality guaranteed, all the necessary products for the daily development of farms and the appropriate veterinary instruments.*

# Índice

<b>A</b>	
Abrebocas .....	114-141-145
Abrebocas de metal, mod. SCHULZE para vacuno y equino .....	141
Abrebocas para sondas esofágicas .....	145
Abrebocas SMITH-BAXTER .....	114
AC. poliglicólico (PGA) .....	118
Adaptador para tubos VACUTAINER .....	239
Adaptador para tubos VACUETTE .....	239
Agitadores magnéticos .....	216
Ágrafes .....	109-119-124
Agua bidestilada .....	226
Agujas de aspiración .....	169-177
Agujas hipodérmicas reusables .....	158-159-160
Agujas hipodérmicas desechables .....	160-161-162
Agujas de sutura .....	120-121-122
Agujas para sutura .....	124
Agujas para tuberculina .....	192
Agujas VACUTAINER y VACUETTE .....	239
Ahuyentadores de conejos .....	45
Ahuyentadores de ciervos .....	45
Ahuyentadores de pájaros .....	45
Ahuyentadores de topos y ratones .....	45
Alargos recoge lechones .....	53
Alargos para sprays de marcar .....	63
Alargos para lápices de marcar .....	63
Alargo para empujador KAWE .....	86
Alargos para jeringas .....	168-171-174-177-182-184-187
Alcohol .....	115
Alfombras antiresbalante para salas de monta .....	235
Alfombra para desinfección .....	127
Alforja para inseminación artificial .....	234
Alimentador con separación de terneros azul de 5 tetinas .....	151
Anemómetro .....	31
Anillas nasales .....	139
Anillas para aves .....	78
Anillas para descolar .....	49
Antiestrés y salud animal .....	47
Anticanibalismo .....	46-50
Arcos para inseminación artificial porcina .....	234
Arnés de nailón para marcaje en ovino con pastillas RAIDEX .....	65
Arnés para prolapso ovino .....	110
Aspirador para pipetas azul, de 1 a 2ml .....	224
Aspirador para pipetas verde, de 2 a 10ml .....	224
Aplicadores de crotales .....	66-67-69-74-76-77
Aplicador ALLFLEX automático .....	76
Aplicador vaporizador nasal .....	188
Aturdidor eléctrico .....	41
Ayuda partos .....	109
<b>B</b>	
Bandeja para test de mamitis .....	153
Baños maría de acero inoxidable con termostato analógico .....	214
Baños maría de acero inoxidable con termostato digital .....	214
Baños maría de plástico con termostato analógico .....	215
Baños maría de plástico con termostato digital .....	215
Báscula de 1000kg con soporte pantalla .....	32
Báscula digital de 150kg, plataforma de 40x30cm .....	33
Báscula digital de bolsillo, 250g precisión 0,1g y 500g precisión 0,1g .....	33
Báscula digital para pesar animales hasta 20kg .....	33-200
Báscula electrónica acero inox estanca, 15kg precisión 1g .....	33
Báscula electrónica 2kg precisión 1g .....	33
Báscula electrónica 6kg precisión 1g .....	33
Báscula móvil digital de aluminio, 300kg .....	32
Báscula móvil digital de aluminio para pesar lechones en grupo, 1000kg .....	32
Básculas para pesaje de animales, pesaje 150Kg lectura 100g y pesaje 300Kg lectura 200g .....	33
Bastones metálicos para sujetar patas .....	142
Bastoncillos para las orejas .....	116
Barra para medición de vacuno HAUPTNER .....	142

# Índice

Batas de tela desechables .....	90
Batas de plástico .....	90
Batas para partos .....	88
Bebederos .....	34 a la 38-116
Biberón .....	116-147-148-149-152
Bisturí .....	101-106-112
Bisturí eléctrico .....	101
Bola colgable especial para bienestar animal .....	47
Bolsas para pies .....	91
Bolsas para calostro .....	152
Bolsas para IA porcinos .....	228
Bombas dosificadoras .....	38
Bomba estomacal .....	145
Bomba peristáltica .....	221
Bombillas de infrarrojos .....	80-81
Bombillas de cuarzo .....	83
Botas desechables .....	91
Botas WELLINGTON superligeras .....	98
Botas WORKER EVA alta .....	98
Botas BEKINA .....	99
Botas DUNLOP .....	100
Bote para recogida de muestras .....	236
Botella para desinfección ambic, acción espumante .....	154
Botella para desinfección de pezones con retorno .....	154
Botella para desinfección de pezones sin retorno .....	154
Botellas biberón para corderos .....	147
Botellas de 1litro .....	223-236
Botella pulverizadora de pezones con alargó .....	154
Botellas de 750 ml con pulverizador .....	237
Botellas de vidrio .....	223
Botellas IA porcinos .....	228
Botellas Speedy drencher .....	152
Bozal grande para cerdas .....	47
Burdizos .....	52

## C

Cabezadas .....	140
Cabezales protectores .....	113
Cabezales para esquiladoras OSTER A-5 y POWER PRO .....	129
CACACAN .....	116
Calentadores de leche .....	147
Calf drencher .....	152
Calostímetro .....	154
Cámaras de video para microscopios .....	210-211
Cámara recolectora conejos .....	200
Camisetas espaBITE .....	93
Campanas suizas con símbolos .....	157
Campanas suizas de acero color bronce .....	157
Campanas suizas de acero color cobre .....	157
Cánula bucal cono Luer Lock universal .....	190
Cánulas mamarias de 3,5cm .....	153
Cánulas mamarias BARTELS .....	153
Cánula mamaria cono Luer Lock .....	153
Cánulas mamarias Luer estériles .....	153
Cánula mamaria metálica cono Luer Lock redondo .....	153
Cánulas IA conejos .....	201
Cánulas postcervicales INSERBO con 4 salidas para la IA porcina .....	229-230
Cánulas postcervicales para la IA porcina .....	229-230-231
Cánulas Pour-on .....	188
Cánula tipo oliva .....	153
Carrete estéril catgut .....	119
Carrete estéril SUPRAMID .....	119
Carrete estéril SUPRAMID blanco .....	119
Carrete estéril de seda trenzada .....	119
Carretillas de poliéster .....	39
Carretillas de bajas .....	40
Carros de leche .....	147
Carro de limpieza y desinfección .....	126
Carro-mesa para la inseminación artificial porcina .....	235
Carros para tratamientos de lechones .....	53-174-175

# Índice

Carro mesa para tratamientos de lechones, en acero inox .....	53
Cartuchos de humo .....	31
Cartuchos para pistola de sacrificio .....	41
Cascos de protección auditiva .....	93
Catéter FUERSTEMBERG .....	153
Catéteres intravenosos .....	164
Catéteres desechables antirreflujo para la IA porcina .....	230 a la 232
Catéteres de caucho nacional tipo melrouse .....	232
Catéteres desechables para la IA porcina .....	230 a la 233
Catéteres desechables tipo esponja .....	230-231-233
Catéteres desechables tipo esponja para nulíparas .....	233
Catéteres para lavados .....	155
Catgut .....	119
Cencerros de acero color bronce .....	157
Centrífugas .....	213
Cepillos para limpieza de animales .....	128
Cerbatana .....	195
Chaqueta para partos .....	88-98
Cierres vaginales .....	109
Cinta métrica para pesar ganado .....	142
Cinta nailon con velcro para vacuno .....	79
Cinta para sutura .....	119
Cinta velcro para lechones .....	47
Coladores de leche .....	151
Colector diluído .....	200
Colector de semen conejos de 5ml .....	200
Colorímetros .....	216
Colgador para botas .....	100
Collares de plástico para ovejas .....	79
Collares de plástico para vacuno .....	79
Collares con y sin cadena para vacas .....	140
Comederos para lechones .....	38
Comederos-bebederos para mascotas .....	116
Compresores de triquina.....	209
Conjunto impermeable .....	98
Contadores .....	142-216
Conectores para sondas endotraqueales .....	113
Correa para prolapsos de vacas .....	110
Corta colas eléctricos .....	50-51
Corta colas de gas .....	50
Corta colmillos .....	48-49
Cortador de pajuelas .....	155
Cortaorejas .....	114
Cortapezuñas .....	133
Cortauñas para pequeños animales tipo guillotina .....	115
Crotales para marcar ganado.....	66 a la 76
Cubetas para llevar instrumentos .....	53
Cubetas para colorímetro .....	216
Cubo fun box colgante para bienestar animal .....	47
Cubos alimentadores de leche MILK Bar .....	150
Cubo para corderos con 6 tetinas .....	147
Cubo blanco de plástico para terneros .....	148
Cubo doble naranja con asa de 10L completo para terneros .....	149
Cubo terneros gris con tetina roja .....	148
Cubrepíes .....	90-91
Cuchillas para corta colas .....	50-51
Cuerdas para partos .....	109
Cureta cortante .....	111
Cúter para abrir botellas y tubos de inseminación artificial .....	234
Cutímetros .....	194
<b>D</b>	
Delantales para partos .....	88
Delantales para ordeño y limpieza .....	98
Depósito mezclador .....	38
Depósitos de 1 y 3 litros .....	169-191
Descalzador de botas .....	100
Descornadores .....	143-144
Descornador manual metálico BARNES .....	143
Descornador a baterías completo BUDDX .....	143

# Índice

Descornador portátil recargable con carga de gas .....	143
Descornador eléctrico tipo revolver .....	144
Descornador eléctrico de 250W .....	144
Descongelador de pajuelas .....	155
Destetadores de aluminio .....	137
Destetadores de caucho .....	137
Destetadores de plástico con cierre de palomilla .....	137
Destetadores de plástico con muelle .....	137
Destetadores de plástico sin cierre .....	137
Destetadores metálicos para tenaza .....	137
Desinfectante INTRA multi-des ga .....	127
Desinfectante para ecógrafos y sondas .....	208
Detergente de laboratorio .....	225
Detectores de celo para vacuno HAUPTNER .....	208
Detectores de gestación .....	208
Detectores de metales .....	146
Detectores de humedad .....	29
Detectores de temperatura .....	29
Digestores .....	209
Dilatador de tetas Dr. NAYLOR .....	153
Diluyentes para semen conejos .....	200
Diluyentes para semen porcino .....	227
Dinamómetros .....	32
Disuasor de aves .....	45
Disco de metal .....	134
Disco abrasivo para pezuñas .....	134
Dosificadoras bucales .....	188-189-190
Dosificadores de jabón .....	94-101-225

## E

Ecógrafos .....	204 a la 208
Elevadores para ganado vacuno .....	141
Emasculadores .....	52
Embriotomo completo HAUPTNER .....	110
Embudo de cristal .....	225
Embudo decantador de separación .....	209
Empujadores .....	85-86
Empujador eléctrico HAUPTNER .....	85
Empujador eléctrico TORERO .....	85
Empujador MAGIC SHOCK .....	86
Empujador MAGIC SHOCK corto .....	86
Empujador STARVET-SHOCK .....	86
Empujador KAWE 21 (por impulsos) .....	85
Envoltorio térmico para vagina de conejos .....	200
Equipo completo de diagnóstico GOWLLANDS Oto-oftal-larin .....	114
Equipos de infusión .....	164
Equipos de alimentación .....	164
Escalpelos LINDE .....	110
Esquiladoras .....	129 a la 132
Esquiladora OSTER A-5 de 1 y 2 velocidades .....	129
Esquiladora OSTER A-5 recargable, Power Pro .....	130
Esquiladora de baterías MOSER ARCO PRO .....	130
Esquiladora con batería de larga duración MOSER AVALON .....	130
Esquiladora recargable OSTER ARTISAN .....	130
Esquiladora OSTER PRO 3000i, de baterías .....	130
Esquiladora ANDIS ULTRAEDGE AGC SUPER, 2 velocidades .....	130
Esquiladora MOSER MAX 45, de dos velocidades .....	130
Esquiladora para ovejas HAUPTNER .....	131
Esquiladora para vacas HAUPTNER .....	131
Esquiladora para caballos HAUPTNER .....	131
Esquiladora para ovejas MASTER, de 300W .....	131
Esquiladora para vacuno RINDER, de 300W .....	131
Esquiladora para ovejas SHEARMASTER .....	131
Esquiladora para vacuno y perros grandes CLIPMASTER .....	131
Esquiladora manual para ovino .....	132
Esquiladora manual para vacuno .....	132
Esquiladora manual dos manos para ovino .....	132
Esquiladora manual dos manos para vacuno .....	132
Esquiladora manual minicorte estrecho .....	132
Esquiladora manual minicorte ancho .....	132

# Índice

Estaciones raticidas .....	44
Esterilizador de catéteres .....	221
Esterilizador de rayos ultravioleta (UV) .....	213
Espéculo nasal y vaginal HARTMANN .....	108
Espéculo nasal y vaginal KILLIAN .....	108
Espéculos vaginales con mango de luz .....	108
Espéculo vaginal desechables .....	108
Espéculo vaginal POLANSKY .....	108
Espuma INTRA Foam Cleaner .....	126
Estabilizadores de corriente .....	220
Estereomicroscopios .....	212
Estrella antiestrés para porcino .....	47
Estuche de instrumental veterinario .....	106
Estufas para desecación y esterilización .....	213
Etiquetadora para dosis de semen .....	234
Evacuador de tetas sistema danés .....	153
Evacuador de tetas según HUG, cabeza cortante .....	153
Evacuador de tetas suizo .....	153
Exterminadores de insectos .....	42
<b>F</b>	
Fendona .....	42
Filtros para semen .....	227
Filtros para leche .....	151
Fishguard STARVET .....	168
Fonendoscopios .....	114
Fórceps de extracción dental .....	114
Fórceps obstétrico .....	108
<b>G</b>	
Gafas de protección .....	92
Gancho obstétrico .....	110
Gancho bucal para dosificadora .....	188
Gas para corta colas .....	50
Gel de ecógrafo .....	208
Gel de exploración .....	156
Gel INTRA Hoot-fit .....	136
Gel lubricante .....	156-234
Gel solución hidroalcohólica SERBONET .....	94-101
Gomas para descolar .....	49
Gorro desechable .....	89-90
Goterros .....	164
Gradillas inox para selladoras de tubos .....	221
Gradillas para tubos de hasta $\varnothing$ 16mm / $\varnothing$ 17mm / $\varnothing$ 30mm .....	238
Grapadora de sutura precargada con 35 grapas (estéril) .....	116-119
Grapas para morro de cerdo .....	139
Grasa para ubres de vacas EUTRA .....	154
Guantes de Látex .....	94-227
Guantes de Nitrilo .....	94-95
Guantes de Plástico .....	94-96-227
Guantes de Vinilo .....	94
Guantes de inseminación artificial .....	96-97-156
Guantes obstétricos .....	49-97
Guía para lazo corredizo .....	109
<b>H</b>	
Higrómetros .....	30
Hisopos estériles para recogida de muestras .....	108-238
<b>I</b>	
Indicador de PH .....	31
Inseminación Artificial para conejo .....	198 a la 201
Inseminación Artificial para porcino .....	225 a la 235
Inseminación Artificial para vacuno .....	155-156
INTRA DERMA .....	115
INTRA Foam Cleaner .....	126
INTRA Hoof-fit .....	135
INTRA Hoof-fit BATH .....	135
INTRA Multi-Des GA .....	127
INTRA Repiderma-Microderm .....	50-136
Introducidos de imanes esofágicos (rígidos y flexibles) .....	146

# Índice

Inyectores de 0,25 / 0,50 / universales .....	155
Imanes esofágico blanco .....	146
Imanes esofágicos STARVET, forma de jaula .....	146
Imanes para planing .....	72
Imperdible vaginal .....	109
Introdutores de imanes .....	146
<b>J</b>	
Jarra de plástico .....	39-151-224
Jeringas completas con cánula recte para I.A. conejos .....	198
Jeringas desechables .....	162-163
Jeringas de tuberculina .....	192-193
Jeringas dosificadoras bucales .....	188-189-190
Jeringas ECO-MATIC .....	186
Jeringas FERROMATIC .....	186
Jeringas GROTEERMAN .....	193-198-199
Jeringas HAUPTNER .....	180 hasta la 183
Jeringas intradérmicas sin aguja .....	173-184-193-198-199
Jeringas neumáticas .....	172 a la 175
Jeringas ROUX .....	184
Jeringas SERENA .....	187
Jeringas STARVET lisas y graduables.....	165
Jeringas STARVET de 1 metro para la vacunación a distancia .....	165
Jeringas SOCOREX.....	176 a la 179
Jeringas tipo revolver .....	180 a la 184
Jeringas vacunadoras .....	166 a la 187
Jeringas vacunadoras STARVET .....	166 a la 171
Jeringas vacunadoras STARVET a baterías .....	171
Jeringas VET-MATIC .....	186
Juego de abre bocas .....	114
Juego de números de aluminio .....	64
Juego de números de bronce .....	64
Juego de números para nitrógeno HAUPTNER .....	64
<b>K</b>	
Kit desechable (2 cubrepiés, bata, gorro y mascarilla) .....	90
Kit de ordeño manual para ovino-caprino .....	151
Kit 10 bolsas calostro + tetina + sonda .....	152
Kit de recogida de fluidos orales para cerdos .....	238
Kit de rumenotomía completo .....	112
Kit completo para autopsias .....	112
Kits reactivos cloro .....	31
<b>L</b>	
Lámparas de quirófano de pie y de techo .....	113
Lámparas protectoras de bombillas de infrarrojos .....	81
Lanza limpiadora-aspiradora SPEEDY para limpiar bebederos y comederos .....	126
Lápices para marcaje de carne .....	64
Lápices para marcar ganado INSERFIX .....	63
Lápices para marcar ganado RAIDEX .....	62
Lápiz cauterizador para descornar .....	144
Lazos para coger cerdos .....	84
Lector ALLFLEX Global Scan GS110 .....	77
Lector ALLFLEX RS420 .....	77
Legra para pezuñas .....	134
Legra derecha de corte doble (dorso cortante) .....	134
Legra izquierda de corte doble .....	134
Legra de corte izquierdo .....	134
Legra derecha de corte doble (hoja total) .....	134
Letras para tauadoras y martillos de tatuar .....	54 a la 61
Levamis Nucleos .....	235
Limas dentales .....	48
Lima a pilas para uñas de perros .....	115
Lima para cascos .....	136
Limpiador con esquineras .....	125
Limpiador recto .....	125
Limpiador tipo circular .....	125
Limpiadores de calzado para entrada en granjas .....	128
<b>M</b>	
Mango limpiador .....	125
Manguitos de poliéster .....	94

# Índice

Máquina para llenado de dosis seminales de conejo .....	201
Marcas ALLFLEX botón hembra .....	74
Marcas ALLFLEX botón hembra electrónico .....	76
Marcas ALLFLEX botón macho .....	74
Marcas ALLFLEX botón macho cuello largo .....	74
Marcas ALLFLEX botón macho júnior .....	75
Marcas ALLFLEX pala hembra maxi .....	75
Marcas ALLFLEX pala hembra mediana .....	74
Marcas ALLFLEX pala hembra júnior .....	75
Marcas ALLFLEX pala hembra Pentag .....	76
Marcas ALLFLEX pala hembra sénior .....	76
Marcas ALLFLEX pala macho mediana .....	74
Marcas ALLFLEX pala macho Pentag .....	75
Marcas ALLFLEX pala macho sénior .....	76
Marcas ALLFLEX kit TST para muestras de tejidos BOT+BOT .....	77
Marcas Dorital HAUPTNER .....	66
Marcas metálicas numeradas para conejos .....	67
Marcas Durafix HAUPTNER .....	67
Marcas INSERFIX botón hembra .....	69
Marcas INSERFIX botón hembra cerrada .....	71
Marcas INSERFIX botón macho con punta de metal .....	69
Marcas INSERFIX botón macho con punta de metal "cuello largo" .....	69
Marcas INSERFIX botón macho con punta de plástico .....	69
Marcas INSERFIX mini .....	67
Marcas INSERFIX pala hembra grande .....	68
Marcas INSERFIX pala hembra grande cerrada .....	71
Marcas INSERFIX pala hembra mini .....	71
Marcas INSERFIX pala hembra júnior .....	70
Marcas INSERFIX pala hembra mediana cerrada .....	71
Marcas INSERFIX pala hembra pequeña cerrada .....	71
Marcas INSERFIX pala hembra mini cerrada .....	71
Marcas INSERFIX pala hembra maxi .....	68
Marcas INSERFIX pala hembra pequeña .....	68
Marcas INSERFIX pala macho grande .....	68
Marcas INSERFIX pala macho júnior .....	70
Marcas INSERFIX pala macho mini .....	71
Marcas INSERFIX pala macho pequeña .....	68
Marcas INSERFIX pala macho sénior .....	70
Marcas INSERFIX para colgar .....	72
Martillo para autopsias .....	111
Martillo para autopsias LUCAE .....	111
Martillo para herrajes de pezuñas con cabeza reforzada .....	133
Martillo percutor TAYLOR .....	106
Martillo percutor TRÖMMER .....	106
Martillo tatuador INSERFIX con depósito incorporado de tinta .....	60-61
Martillos tatuadores .....	54-60-61
Mascarillas .....	90-92
Medidor de cloro y dióxido de cloro.....	31
Medidor de calostro (calostímetro) .....	154
Medidor de grasa LEAN METER .....	208
Medidor de grasa con lector de chips INSERBO .....	208
Medidor de humedad para grano .....	240
Medidor de humedad para paja y heno .....	240
Medidor de temperatura para grano .....	240
Mesa de quirófano .....	113
Microscopios .....	210-211
Microtubos EPPENDORF 1,5ml .....	238
Mochila tanque de aire .....	175
Mono impermeable para lavado y limpieza .....	98
Mono para partos .....	88
Monos desechables .....	89
MONOVETTE L suero de 9 ml .....	237
Multiplicador de presión para tanques .....	174
<b>N</b>	
Narigueras .....	138
Neveras de dobles puertas pasantes para la bioseguridad en granjas y centros I.A. ....	217
Neveras de transporte con compresor .....	220
Neveras de transporte con celula Peltier y bolsa nevera .....	220
Neveras fijas de 70 hasta 600L de capacidad .....	217 a la 219

# Índice

Nebulizadores para vacunas TURBAIR .....	195
Números para tatuadoras y martillos de tatuar .....	54-55-57-61
<b>O</b>	
Otoscopio GOWLLANDS .....	114
Otoscopio-Oftalmoscopio GOWLLANDS .....	114
<b>P</b>	
Pajuelas de 0,25 .....	155
Pajuelas de 0,50 .....	155
Palas arreadoras para empujar ganado .....	85
Palas dispensadoras de pienso .....	39
Pala dispensadora con báscula .....	39
Pala-jarra dispensadora para sólidos y líquidos .....	39
Pantalón para partos .....	88
Pantalón desechable .....	91
Paños de limpieza para ubres .....	154
Papel indicador mamicis .....	153
Pasta para descornar en jeringa dosificadora .....	144
Pastillas RAIDEX para arnés .....	65
Pediluvio acero inox con bandeja-muelles .....	127
Pediluvio acero inox doble con bandeja-muelles .....	127
Pediluvio de desinfección .....	127
Pediluvio de desinfección caucho .....	127
Pediluvio INTRA BATH doble 2 partes más gradilla inox .....	135
Pediluvio super-kombi para cascos .....	128-135
Pelotas antiestrés para porcino .....	47
Phmetros portátiles .....	31
Pinza ADSON .....	107
Pinza-Alargo recoge lechones tipo revólver de 80cm .....	53
Pinza ALLIS .....	106
Pinza aturdidora para ovejas .....	41
Pinza BACKHAUS .....	106
Pinza campo cangrejo SCHAEDEL .....	106
Pinza CRILE .....	105
Pinza de disección .....	107
Pinza de sujeción para termómetros baño maría .....	27
Pinza extractora de grapas .....	116-119
Pinza intestinal .....	105
Pinza KOCHER .....	104
Pinza mosquito .....	105
Pinzas umbilicales .....	48
Pinza para sujetar patas .....	141
Pinza para sujetar colas .....	142
Pinza para espinas FELCHENFELT .....	107
Pinza para extracción de garrapas .....	116-119
Pinza para oído, según LUCAE .....	107
Pinza para panza BLENDING .....	107
Pinza para útero cabeza goma .....	107
Pinza PEAN .....	105
Pinza tipo cocodrilo HARTMANN .....	106
Pinza tira lenguas COLLING .....	107
Pipetas aforadas .....	224
Pipetas automáticas fijas .....	224
Pipetas automáticas graduables .....	224
Pipetas graduadas .....	224
Pipetas Pasteur de plástico .....	224
Pipetas Pasteur de plástico graduadas .....	224
Pipetas Pasteur de vidrio cortas .....	224
Pipetas Pasteur de vidrio largas .....	224
Pipeta para conteo de semen conejo .....	200
Pistola de espuma dosificable, con depósito de 2l .....	126
Pistola para extracción de grasa .....	208
Pistolas para sacrificio de animales .....	41
Pistolas para sacrificio de conejos .....	41
Pistolas para spray de marcar .....	63
Placas calentable para microscopio .....	215
Placa de Petri 55x14mm .....	236
Planning para control de granjas .....	72

# Índice

Plantillas BEKINA .....	99
Potro de castración de lechones tipo asiento .....	53
Potro de castración de lechones standard .....	53
Potros para castración acero inox, con soporte .....	53
Potro para monta fijo y móvil con apoyo .....	235
PORKIREP Spray tranquilizante de cerdos .....	46-50
Portagujas OLSEN-HEGAR con tijera .....	123
Portagujas GUILLES con tijera .....	123
Portagujas MATHIEU .....	123
Portagujas MAYO .....	123
Portalámparas para bombillas de cuarzo .....	83
Portalámparas para bombillas de infrarrojos .....	81
Portarrollos de papel .....	154-235
Povidona yodada Desinpov de 500ml .....	115
Precintos de plástico .....	78
Psicrómetros para medir humedad .....	30
Pulseras de plástico para identificación de vacunos .....	79
Puntas micropipetas amarillas de 5 a 200ml .....	224
Puntas micropipetas azules de 100 a 1000ml .....	224
Puntas para limas dentales .....	48
Protector de hombros .....	88

## R

Raspador dental para perros (varios medidas) .....	115
Raqueta eléctrica matamoscas .....	42
Raticidas .....	44
Reactivo para test de California .....	153
Reflectores de cuarzo .....	82
Rollo de papel para limpieza de ubres .....	154
Rotulador ALLFLEX Tag-Pen .....	72
Rotulador para marcas INSERFIX .....	67-72
R.U.M. Spray tranquilizante .....	46

## S

Sacos negros grandes gruesos .....	40
Seda trenzada .....	118-119
Selladoras para el envasado de tubos IA .....	221
Separador de leche QUARTER MILKER .....	147
Separador FARABEUF .....	111
Separador VOLKMAAN .....	111
Separador WEITLANER .....	111
Serrucho para autopsias .....	111
Sierra para autopsias .....	111
Sillas de ordeño con asiento de plástico o de madera y cinta de sujeción .....	154
Sirgas para cuernos y mangos para sirgas de descornar .....	143
Sonda acanalada .....	106
Sonda de recambio Waterproof para FUTURE-2 .....	207
Sonda esofágica .....	145
Sondas endotraqueales .....	113
Sonda multifrecuencial FUTURE-1 .....	205
Sonda nasogástrica .....	145
Sonda para calostro de lechones y lechales .....	152
Sonda para FUTURE Wifi .....	206
SPLAYLEGSTOP para lechones .....	47
Spray INTRA DERMA de 100ml .....	115
Spray para detectar celo en cerdas .....	234
Spray para marcar ganado INSERFIX y RAIDEX .....	62-63
Spray desinfectante .....	101-208
STERIMATIC kit completo .....	160
SUPRAMID .....	118

## T

Tableros para arrear ganado INSERBO .....	85
Tablet con pantalla de 7" waterproof IP-68 y antigolpes .....	205
Tapas para baños maría inox .....	214
Tapones para oídos 3M .....	93
Tampón para martillo tatuador INSERFIX .....	61
Tampón para tinta de números manuales .....	59
Tarros de boca ancha con tapa y obturador .....	236
Tatuadoras .....	55-56

# Índice

Tatuadoras articuladas .....	56
Tatuadoras rotativas .....	56
Tenaza ALLFLEX .....	74-76
Tenaza ALLFLEX aplicadora TST muestras de tejidos .....	77
Tenazas corta colmillos .....	49
Tenaza HAUPTNER para ágrafes de sutura .....	109-119-139
Tenaza grapas para morro de cerdo universal .....	139
Tenaza para anilla nasal de vacuno .....	139
Tenaza para anilla nasal de cerdo .....	139
Tenaza para ágrafes de sutura y grapas morro .....	139
Tenaza para ágrafes y grapas HAUPTNER .....	139
Tenaza para cascos, con dientes .....	133
Tenaza para colocar destetadores metálicos .....	137
Tenaza para crotales universal .....	77
Tenazas para gomas descolar .....	49
Tenaza para marcas de conejos .....	67
Tenaza para marcas INSERFIX .....	69
Tenaza para marcas INSERFIX con aguja basculante .....	76
Tenaza para marcas INSERFIX mini .....	67
Tenaza remachadora para pezuñas .....	133
Tenazas sacabocados .....	66
Termómetros ambiente .....	27
Termómetro avicultura .....	27
Termómetros con conexión a ordenador .....	29
Termómetros con lanza .....	30
Termómetros de máxima y mínima .....	27-30
Termómetros de veterinaria con y sin anilla .....	28
Termómetros de veterinaria digitales .....	28
Termómetro de veterinaria punta flexible .....	28
Termómetro de veterinaria extragrande .....	28
Termómetro de veterinaria digital ACCUVET .....	28
Termómetros de infrarrojos .....	29
Termómetros digitales con sonda exterior .....	30
Termómetros digitales con sonda interior .....	30
Termómetros para líquidos .....	27
Tetina para pequeños animales .....	116
Tetina de recambio para corderos de caucho calidad extra .....	147
Tetina de recambio para biberón de corderos .....	147
Tetina de recambio roja para botella biberón de cordero .....	147
Tetina terneros de caucho calidad extra para cubo .....	148
Tetina terneros para cubo negro .....	148
Tetina terneros de caucho calidad extra para cubo verde .....	148
Tetina terneros de caucho extra para botella .....	148
Tetina de recambio roja, botella biberón terneros .....	148
Tetina flotante para terneros .....	149
Tetina para botella biberón de terneros .....	149
Tetina para cubo doble naranja .....	149
Tetina de terneros negra MILK Bar .....	150
Tijeras costauñas para gatos .....	115
Tijeras costauñas para perros .....	115
Tijeras IRIS .....	103
Tijeras JESCO .....	103
Tijeras LISTER .....	103
Tijeras LITTAUER para quitar puntos .....	103
Tijeras MAYO-STILLE .....	103
Tijeras METZENBAUM .....	103
Tijera para esquilar .....	132
Tijera para cascos .....	134
Tijera para cascos dentada .....	134
Tijera para cascos reforzada FELCO, mango rotativo .....	134
Tijera para cascos-pezuñas reforzada FELCO .....	134
Tijeras rectas y curvas .....	102
Tijeras SPENCER para quitar puntos .....	103
Tinta de tatuar alimentaria .....	59
Tinta de tatuar carne decomisada .....	59
Tinta de tatuar en frasco .....	58
Tinta de tatuar líquida .....	61
Tinta para marcar ovejas .....	65
Tinta sistema bola .....	58

# Índice

Tiras indicadoras de peróxido, dióxido de cloro y cloro .....	31
Tiza para marcaje Sisa RAIDEX .....	64
Toallitas "Biodegradables" para higiene de cerdas, no espermicidas .....	228
Toallitas desinfectantes para higiene de cerdas, no espermicidas .....	228
Toallitas desinfectantes para instrumental .....	101
Toallitas desinfectantes para ubres .....	154
Traba evitacoces .....	141
Trampas para cucarachas .....	42
Trampas para moscas .....	42
Trampas para ratas .....	43
Trampas para ratones .....	43
Tranquilizante de cerdos .....	46-50
Tranquilizante de usos múltiples .....	46
Transformadores 220v-12v para neveras de transporte .....	220
Triquinoscopios de pantalla .....	209
Trocar de tornillo, material plástico .....	145
Trocar HAUPTNER con dos cánulas .....	145
Trocar mango de madera .....	145
Trocar mango de metal .....	145
Trocar universal metálico .....	145
Tubo de silicona de 1m .....	169
Tubo presuero de 5ml .....	237
Tubos para muestras .....	237-238
Tubos soldables extrafinos para dosis de semen INSERBO .....	228
Tubos VACUTAINER con EDTA de 4ml .....	239
Tubos VACUTAINER de 5ml .....	239
Tubos VACUETTE plástico de 4,5ml .....	239
<b>U</b>	
Ungüento para ubres de vacas .....	154
<b>V</b>	
Vacunador de garrocha .....	195
Vacunadoras METÁLICAS .....	181-182
Vacunadoras SOCOREX .....	176 a la 179
Vacunadoras STARVET .....	166 a la 171-198
Vainas .....	155
Válvula de aluminio para tetina corderos .....	147
Válvula de plástico para tetina corderos .....	147
Válvula completa de recambio para cubo de plástico para terneros .....	148
Vagina artificial conejos .....	200
Vagina artificial de silicona para conejos .....	200
Vagonetas para pienso de poliéster .....	39
Varilla recoge imanes .....	216
Vaselina líquida de 1L .....	234
Vendas de alquitrán .....	116
Vendas de gasa .....	116
Vendas cohesivas .....	116
Vendas cohesivas INSERFIX .....	117
Vendas elásticas adhesivas .....	116
Venda sintética poliéster blanca .....	116
Vestuario .....	88 a la 93
Vídeo-endoscopio-otoscopio completo con tres cámaras de vídeo .....	114
Vídeo gafas para ecógrafo FUTURE-1 .....	205
Vidrio científico .....	222 a la 225

# Index

## A

A.I buddy for gilts (yellow) .....	234
A.I buddy for SOWS (green) .....	234
Alcohol 70° bottle 1L .....	115
ALLFLEX Global Scan GS110 reader .....	77
ALLFLEX RS420 reader .....	77
ALLFLEX tissue sampling TST tag applicator .....	77
Analog counter .....	142
Anemometers .....	31
Animal welfare, hanging fun box cube .....	47
Animal welfare, special hanging ball .....	47
Anticanibalism spray .....	50
Anti-kick bar .....	141
Anti-stress ball for pigs .....	47
Anti-stress star for pigs .....	47
Applicator, for rubber rings .....	49
Applicator, HAUPTNER suture wire ring .....	109
Applicator, for rubber rings, plastic .....	49
Applicators for ear tags .....	66-67-69-74-76-77
Apron, milking and washing .....	98
Artificial insemination for cattle .....	155-156
Artificial insemination for pigs .....	225 to 233
Artificial insemination for rabbits .....	198 to 201
Autopsy kit .....	112

## B

Bags, big thick blacks .....	91
Bags, black plastic for shoes .....	91
Bags, for semen .....	228
Blood collection set, butterfly type .....	164
Bandages, cohesive .....	116-117
Bandages, elastic adhesives .....	116
Bandages, INSERFIX cohesive .....	117
Bandages, gauze .....	116
Bandages, KROMBERG tar .....	116
Bandages, white polyester synthetic .....	116
Beakers .....	223
Bell, Swiss, steel bronze colour .....	157
Bell, Swiss with drawing .....	157
Bell, Steel, brass colour .....	157
Bird rings with clip .....	78
Blowpipe, complete .....	195
Boots, BEKINA and DUNLOP .....	99-100
Boots, light (-30°C) .....	98
Boots, super light safety S4 (-30°C) .....	98
Boot holder stainless steel for 4 pairs of boots, inclined model .....	100
Boot remover .....	100
Bottles for dose of semen .....	228
Box to transport utensils in livestock .....	53
Braided silk .....	118
Braided silk cassette (sterile) .....	119
Brush to clean glass material .....	225
Brushes with spring for animals cleaning .....	128
Brushes with spring and tank for animals cleaning .....	128
Bulbs, hard glass INSERBO infrared, clear .....	80
Bulbs, hard glass INSERBO infrared, red .....	80
Bulbs, hard glass PHILIPS infrared, clear .....	81
Bulbs, hard glass PHILIPS infrared, red .....	81
Bulbs, INSERBO infrared, clear .....	80
Bulbs, INSERBO infrared, red .....	80
Bulbs, INSERBO red quartz .....	83
Bulbs, INSERBO quartz .....	83
Bulbs, INTERHEAT infrared, clear .....	81
Bulbs, INTERHEAT infrared, red .....	81
Bulbs, PHILIPS infrared, red .....	81
Bull holder (EISENHUT) .....	138
Bull holder (HARMS) .....	138
Bull holder with handle .....	138
Bull holder with spring .....	138
Bürker chambers .....	225

# Index

## C

CACACAN, box of 25 units .....	116
Caffeine (pure) .....	222
Calf bucket holder .....	148
Calf drencher profi with flexible probe 105 cm .....	152
Calf drencher with flexible and rigid probe .....	152
Calf feed bucket with and without teat .....	148
Calf feed bucket, double orange .....	149
Calf feeding milk bottles .....	148
Calf feeding grey bucket with red teat and valve .....	148
Calf teat floating .....	149
Calf teats for black bucket .....	149
Calf teats for double bucket .....	149
Calf teats for green bucket, extra quality rubber .....	148
Calf teats for green bucket, extra quality rubber, for bottle .....	148
Calf teats, for feeding bottle .....	148
Calf teats, for MILK BAR black .....	150
Calf teats, red for milk bottle .....	148
Calf teats, red for grey and green bucket .....	148
Calf rubber teat for bucket .....	148
Calliper, analog for tuberculin test .....	194
Calliper, analog for tuberculin test with spring .....	194
Calliper, analog for tuberculin test with spring for left-handed .....	194
Calliper, HAUPTNER gun type analog and digital for tuberculin test .....	194
Calliper, with watch for tuberculin test .....	194
Cannula, disposable curved and straight for rabbits artificial insemination .....	201
Cannula, glass curved for rabbits artificial insemination .....	201
Cannula, intra-uterine with and without catheter .....	229-230-231
Cap, disposable .....	89
Cartridges, smoke .....	31
Cartridges for animal slaughter gun .....	41
Castrators .....	52-53
Castrating tables for piglets .....	53
Catgut, sterile cassette .....	119
Catheter, spiral and foam type disposables .....	230 to 233
Catheter, Melrouse type national rubber .....	232
Cattle heat detector, HAUPTNER .....	208
Cattle hobble adjustable .....	141
Cattle hobble standard .....	141
Cattle labour's help .....	109
Centrifuges .....	213
Claw, revolver-type for piglets .....	53
Cleaning and disinfection trolley .....	126
Cleaning spray for clipper heads .....	130
Cleaning vacuum lance to clean drinkers and feeders, SPEEDY .....	126
Clippers .....	129 to 132
Clipper, ANDIS ULTRAEDGE AGC SUPER 2 speeds .....	132
Clipper, CLIPMASTER for cattle and big dogs .....	131
Clipper heads, for OSTER A5 and POWER PRO .....	129
Clipper heads, TAILWELL 2 cattle tail .....	131
Clipper, OSTER ARTISAN rechargeable .....	130
Clipper, OSTER A5 .....	129
Clipper, OSTER A5, rechargeable, Power Pro .....	130
Clipper, OSTER PRO 3000i battery .....	130
Clipper, MASTER sheep .....	131
Clipper, MOSER ARCO PRO battery .....	130
Clipper, MOSER AVALON with long lasting battery .....	130
Clipper, MOSER MAX 45 2 speeds .....	130
Clipper, HAUPTNER for cattle .....	131
Clipper, HAUPTNER for horse .....	131
Clipper, HAUPTNER for sheep .....	131
Clipper, hand, narrow cutting .....	132
Clipper, hand, wide cutting .....	132
Clipper, hand for sheep and for cattle .....	132
Clipper, two hand for sheep and for cattle .....	132
Clipper, RINDER for cattle .....	131
Clipper, SHEARMASTER for sheep .....	131
Coat, disposable cloth with pocket for visits .....	90
Coat, disposable green closed plastic .....	90

# Index

Coat, disposable plastic closed .....	90
Coat, disposable plastic with buttons .....	90
Coaxer, HAUPTNER .....	85
Coaxer, MAGIC SHOCK blue .....	86
Coaxer, MAGIC SHOCK short .....	86
Coaxer, STARVET-SHOCK .....	86
Coaxer, TORERO .....	85
Coaxer, KAWE .....	85
Coaxer, KAWE 21 .....	85
Colostrum bags, kit 10 colostrum bags + teat + probe .....	152
Colostrum scale .....	154
Colostrum probe for piglets and calves .....	152
Colorant for semen (non-spermicidal) .....	227
Colorimeters .....	216
Compressors for trichina .....	209
Container, 3L STARVET complete .....	169
Container, 3L STARVET flat transparent .....	169
Container, 3L STARVET transparent .....	169
Cow lifter .....	141
Curette, VOLKMANN cutting .....	111
Curette, VOLKMANN double cutting .....	111
<b>D</b>	
Dehorner paste in dosing syringe .....	144
Dehorning, BARNES metal .....	143
Dehorning caustic pen .....	144
Dehorning, complete battery .....	143
Dehorning, electric 250w .....	144
Dehorning, electric pistol handle .....	144
Dehorning, portable, rechargeable with gas cartridge .....	143
Dehorning saw wire .....	143
Dehorning, saw wire handle .....	143
Dehorning tips .....	144
Dental scaler for dogs (several sizes) .....	115
Detector, USB temperature and humidity .....	29
Detector, temperature .....	29
Detector, metal .....	146
Detector, gestation .....	208
Detector, HAUPTNER for cattle heat .....	208
Digestors for meat analysis .....	209
Disinfectant cleaner for shoes .....	128
Disinfectant rug .....	127
Dispenser, automatic infrared soap and gel .....	94-101-225
Dispenser, manual soap .....	94-225
Dispensing shovels .....	39
Dispensing shovels with built-in scale .....	39
Drainers .....	223
Drinkers .....	34 to 38
Dynamometers .....	32
<b>E</b>	
Ear notcher for dogs .....	114
Ear notcher HAUPTNER .....	66
Ear notcher, nickel-plated .....	66
Ear plugs, 3M banded .....	93
Ear plugs, 3M ultrafit corded .....	93
Ear tags applicators, ALLFLEX and ALLFLEX automatic .....	74-76-77
Ear tags applicator, for rabbits .....	67
Ear tags applicators, HAUPTNER Dorital .....	66
Ear tags applicators, INSERFIX .....	67-69-76-77
Ear tags applicators, INSERFIX with tilting needle .....	76
Ear tags applicators, for mini INSERFIX ear tags .....	67
Ear tags applicators, universal .....	77
Ear tags, ALLFLEX, female and male, shovel form .....	76
Ear tags, ALLFLEX medium, female and male, shovel form .....	74
Ear tags, ALLFLEX round female and male .....	74
Ear tags, ALLFLEX round male, long neck .....	74
Ear tags, ALLFLEX round female, FDX electronic .....	76
Ear tags, ALLFLEX kit for tissue sampling BOT+BOT .....	77

# Index

Ear tags, junior ALLFLEX, female and male, shovel form .....	75
Ear tags, maxi ALLFLEX, female, shovel form .....	75
Ear tags, HAUPTNER Dorital .....	66
Ear tags, HAUPTNER Durafix .....	67
Ear tags, HAUPTNER Supercrotal .....	66
Ear tags, INSERTIFIX close button female .....	71
Ear tags, big INSERTIFIX, female and male, shovel form .....	68
Ear tags, junior INSERTIFIX, female and male, shovel form .....	70
Ear tags, INSERTIFIX, female, button form .....	69
Ear tags, INSERTIFIX, male, button form with metallic point .....	69
Ear tags, INSERTIFIX, male, button form with plastic point .....	69
Ear tags, INSERTIFIX big female, shovel form, closed model .....	71
Ear tags, INSERTIFIX medium, female, shovel form, closed model .....	71
Ear tags, senior ALLFLEX, female and male, shovel form .....	76
Ear tags, maxi INSERTIFIX, female, shovel form .....	68
Ear tags, mini INSERTIFIX .....	71
Ear tags, senior INSERTIFIX, female and male, shovel form .....	70
Ear tags, small INSERTIFIX, female and male, shovel form .....	71
Ear tags, small INSERTIFIX, female, shovel form, closed model .....	71
Electrosurgery .....	101
Emasculator, HAUSSMAN .....	52
Emasculator, REIMERS for horse .....	52
Emasculator, VERBOCZY for horse .....	52
Emasculator, SERRA .....	52
Embriotome, complete HAUPTNER .....	110
Endotracheal probes with olive-tip .....	113
Eosine .....	222
Erlenmeyer .....	222
ESPABITE Tshirts .....	93
EUTRA milking fat .....	154
EUTRERGEL for cow udders .....	154
Exploration gel, BOVI-VET .....	156
Extender, for pigs A.I. .....	227
Extender, for rabbits A.I. .....	200
Extension for marking sprays (INSERTIFIX) .....	63
Extensions for marking sticks .....	63
Exterminators, electronic for insect .....	42

## F

Fat extraction pistol .....	208
Fat meters .....	208
Feeders bucket, Milk Bar .....	150
Feeders, for piglets .....	38
Feeders-drinkers for pets .....	116
Feeding bottle for small animals .....	116
Feeding bottle 250ml with probe for colostrum lambs .....	152
Feeding bucket for lambs .....	147
Feeding infusion set with bag .....	164
Forceps, ADSON dissection .....	107
Foam gun .....	126
Footbath, disinfection .....	127
Footbath, double stainless steel with tray-springs .....	127
Footbath, rubber disinfection .....	127
Footbath, stainless steel with tray-springs .....	127
Footbath, Super-kombi for hoofs .....	128
Footbath double 2 parts plus stainless steel dack (INTRA BATH) .....	135
Forceps, ALLIS .....	106
Forceps, BACKHAUS .....	106
Forceps, BLENDING for paunch .....	107
Forceps, COLLING tongue .....	107
Forceps, CRILE .....	105
Forceps, Dissection .....	107
Forceps, elbow ear .....	107
Forceps, FENCHENFELT splinter .....	107
Forceps, for uterus with rubber top .....	107
Forceps, HARTMANN crocodile .....	106
Forceps, intestinal .....	105
Forceps, mosquito .....	105
Forceps, KOCHER .....	104
Forceps, LUCAE ear .....	107

# Index

Forceps, obstetric danish model .....	108
Forceps, obstetric WITT .....	108
Forceps, PEAN .....	105
Forceps, SCHAEDEL towel clamp .....	106
Forceps, tooth extraction .....	114
Formaldehyde .....	225
<b>G</b>	
Gas for tail docker .....	50
Gerlach needle .....	124
Gestation detector, PREG-TONE .....	208
Glass funnel .....	225
Gloves, 85cm elastic supersensitive .....	97
Gloves, 90cm sensitive .....	96
Gloves, 90cm sensitive (GLOVET) .....	97
Gloves, 90cm sensitive with neck lace .....	97
Gloves, 90cm supersensitive .....	96
Gloves, 90cm orange sensitive .....	96
Gloves, 90cm pig obstetric .....	97
Gloves, disposable plastic, special width .....	94
Gloves for shoulder and armpit protection (NECK) .....	97
Gloves, STARVET powder free and with powder latex .....	94
Gloves, orange rough nitrile .....	95
Gloves, PEHA-SOFT nitrile .....	94
Gloves, powder free black nitrile .....	95
Gloves, powder free nitrile .....	95
Gloves, STARVET powder free vinyl .....	94
Gloves, STARVET with powder vinyl .....	94
Gloves, supersensitive for shoulder and armpit protection .....	97
Gloves with elastic band .....	96
Grooved director .....	106
Guns for animals slaughter .....	41
Guns for piglets slaughter .....	41
Guns for rabbits slaughter .....	41
<b>H</b>	
Halter for calves, nylon .....	140
Halter for calves and cows .....	140
Halter for cows .....	140
Halter for cows with chain .....	140
Hammer, autopsy LUCAE metallic handle .....	111
Hammer, autopsy wooden handle .....	111
Hammer, heavy duty shoeing .....	133
Hammer, TAYLOR striker .....	106
Hammer, TRÖMMER striker .....	106
Harness for sheep marking with RAIDEX wax blocks (in nylon) .....	65
Harness for sheep prolapse .....	110
Hearing protection helmets with Protac III voice hearing, 3M .....	93
Hearing protection helmets, 3M Peltor Optime .....	93
Heatable plates, INSERBO .....	215
Hoof cutter, articulated .....	133
Hoof cutter, lateral cutting .....	133
Hoof cutter, non serrated .....	134
Hoof cutter, serrated .....	134
Hoof file .....	136
Hoof knife .....	134
Hoof knife, left hand, double sided cutting, wooden handle .....	134
Hoof knife, left hand, wooden handle .....	134
Hoof knife, righthand, all blade cutting, wooden handle .....	134
Hoof knife, righthand, double sided cutting, wooden handle .....	134
Hoof knife, righthand, wooden handle .....	134
Hoof nail clinch, 35cm .....	133
Hoof plier, with teeth .....	133
Hoof scissors, FELCO .....	134
Hoof scissors, FELCO, rotative .....	134
Hydroalcoholic solution gel, SERBONET .....	94-101
Hygrometers and hygrothermometers .....	30
<b>I</b>	
Immersion oil .....	222

# Index

<i>Indicators strips, Peroxide, Chlorine Peroxide and Chloride</i> .....	31
<i>Indicators, PH</i> .....	31
<i>Indicators, mastitis</i> .....	153
<i>Infusion set, disposable</i> .....	164
<i>Infusion set, Luer Lock two way</i> .....	164
<i>Infusion set reusable Luer cone with needle</i> .....	164
<i>Infusion set, Y Luer Lock double line dropper type</i> .....	164
<i>Injector, 0,25</i> .....	155
<i>Injector, 0,50</i> .....	155
<i>Injector, universal</i> .....	155
<i>Insole, BEKINA standard</i> .....	99
<i>Insole, BEKINA ergonomic and inmpact protection</i> .....	99
<i>INTRA BATH footbath double 2 parts plus stainless steel rack</i> .....	135
<i>INTRA DERMA</i> .....	115
<i>INTRA Foam Cleaner</i> .....	126
<i>INTRA Hoof-fit</i> .....	135
<i>INTRA Hoof-fit BATH</i> .....	135
<i>INTRA Microderm</i> .....	136
<i>INTRA Multi-Des GA</i> .....	127
<i>INTRA Repiderma-Microderm</i> .....	50
<b>J</b>	
<i>Jar for milk, plastic</i> .....	151
<i>Jangle, steel, bronze colour</i> .....	157
<b>L</b>	
<i>Labelling machine for semen samples</i> .....	234
<i>Laboratory detergent GLASSGEN</i> .....	225
<i>Lamb feeding bottle</i> .....	147
<i>Lamb spare teat</i> .....	147
<i>Lamp, ceiling for operating room</i> .....	113
<i>Lamp, free standing for operating room</i> .....	113
<i>Lamp holder, for infrared bulbs</i> .....	81
<i>Lamp-holder for quartz bulbs</i> .....	83
<i>LEVAMIX</i> .....	235
<i>Leg and neck metallic crook</i> .....	142
<i>Leg metallic crook</i> .....	142
<i>Lubricant coolant spray for clippers</i> .....	130
<i>Lubricant gel-gynecologist disinfectant</i> .....	156
<i>Lubricant gel, RAIDEX</i> .....	156
<b>M</b>	
<i>Magnetic stirrers</i> .....	216
<i>Markers for ear tags</i> .....	67-72
<i>Marking sprays applicator</i> .....	63
<i>Marking sprays, INSERFIX</i> .....	63
<i>Marking sprays, RAIDEX</i> .....	62
<i>Marking sprays, RAIDEX sheep marking</i> .....	62
<i>Marking sticks, INSERFIX</i> .....	63
<i>Marking sticks, RAIDEX</i> .....	62
<i>Mask, disposable surgical with additional reinforcement</i> .....	90
<i>Mask, for gases and vapors (3M)</i> .....	92
<i>Mask, for gases and vapors especially ammonia (3M)</i> .....	92
<i>Mask, DRÄGER FFP3 with valve</i> .....	90
<i>Mask, DRÄGER FFP1 with filter</i> .....	90
<i>Mask, DRÄGER FFP2</i> .....	90
<i>Mask, DRÄGER FFP2 and FFP3 with valve</i> .....	90
<i>Mask, FFP1 foldable with valve (3M)</i> .....	92
<i>Mask, FFP1 and FFP2 with valve (3M)</i> .....	92
<i>Mask, surgical type IIR</i> .....	90
<i>Mastitis indicator paper</i> .....	153
<i>Mating table, wood lined, fixed and mobile with support</i> .....	235
<i>Measuring sticks, HAUPTNER</i> .....	142
<i>Metal detector</i> .....	146
<i>Microscopes</i> .....	210-211
<i>Microscopes with phase contrast kit</i> .....	210
<i>Milk filter socks stitched</i> .....	151
<i>Milk filter Ø 200 mm</i> .....	151
<i>Milk sucking preventor, metallic and aluminium</i> .....	137
<i>Milk sucking preventor, metallic applicator</i> .....	137
<i>Milk sucking preventor, plastic with butterfly adjustment nut</i> .....	137

# Index

<i>Milk sucking preventor, plastic with spring</i> .....	137
<i>Milk sucking preventor, rubber</i> .....	137
<i>Milk sucking preventor, yellow plastic without lock</i> .....	137
<i>Milk strainer, aluminium</i> .....	151
<i>Milk strainer spare filter set</i> .....	151
<i>Milk trolley stainless steel with pump, mixer and pasteuriser</i> .....	147
<i>Milk trolley with pump and mixer</i> .....	147
<i>Milk warmer, electric 2.300w</i> .....	147
<i>Milk warmer, electric 2.300w with digital display</i> .....	147
<i>Milking chair with plastic seat and fastening tape</i> .....	154
<i>Milking chair with wooden seat and fastening tape</i> .....	154
<i>Mouth gag</i> .....	114
<i>Mouth gag for probangs</i> .....	145
<i>Mouth gag, SMITH-BAXTER kit</i> .....	114
<i>Mouth gag, Schulze metal for cattle and horse</i> .....	141
<i>Muzzle, big for sows</i> .....	47

## N

<i>Nail clipper for cats and dogs</i> .....	115
<i>Nail cutter for small animals with guillotine action</i> .....	115
<i>Nail trimmer for dogs (battery powered)</i> .....	115
<i>Nasal-gastric probes</i> .....	145
<i>Necklace with chain for cows</i> .....	140
<i>Necklace with double chain for cows</i> .....	140
<i>Necklace without chain for cows</i> .....	140
<i>Needle, disposable sterile, STARVET</i> .....	161
<i>Needle holder, GUILLES scissors</i> .....	123
<i>Needle holder, OLSEN-HEGAR scissors with hard mounth (golden handle)</i> .....	123
<i>Needle holder, OLSEN-HEGAR scissors</i> .....	123
<i>Needle holder, MATHIEU</i> .....	123
<i>Needle holder, MAYO</i> .....	123
<i>Needle, hypodermic</i> .....	160
<i>Needle, hypodermic, STARVET</i> .....	159
<i>Needle, hypodermic, STARVET FORTE</i> .....	158
<i>Neubauer chamber</i> .....	225
<i>Nigrosine</i> .....	222
<i>Nose rings, applicator</i> .....	139
<i>Nose rings, nickel-plated steel</i> .....	139
<i>Nose rings, HAUPTNER bright steel</i> .....	139

## O

<i>Obstetric blunt hook</i> .....	110
<i>Obstetric coats</i> .....	88
<i>Obstetric jackets</i> .....	88
<i>Obstetric long apron</i> .....	88
<i>Obstetric overalls</i> .....	88
<i>Obstetric pointed hook (HARMS)</i> .....	110
<i>Obstetric trousers</i> .....	88
<i>Operating table, adjustable electric</i> .....	113
<i>Otoscope, GOWLLANDS</i> .....	114
<i>Otoscope-ophthalmoscope, GOWLLANDS</i> .....	114
<i>Otoscope-ophthalmoscope and laryngoscope, GOWLLANDS</i> .....	114
<i>Overboots, blue with laces</i> .....	91
<i>Overboots, disposable with elastic band</i> .....	91
<i>Overboots, green with laces</i> .....	91
<i>Overall, disposable with hood "thick" chemical protection</i> .....	91
<i>Overalls, blue disposable with hood</i> .....	89
<i>Overalls, blue disposable without hood, green</i> .....	89
<i>Overalls, green disposable with hood</i> .....	89
<i>Overalls, green plasticized without hood</i> .....	89
<i>Overalls, white disposable with and without hood</i> .....	89
<i>Overalls, white plasticized with and without hood</i> .....	89
<i>Overalls, washing and cleaning</i> .....	98
<i>Oversleeves polyester</i> .....	94
<i>Overshoes with elastic band</i> .....	91
<i>Ovoscope</i> .....	212

## P

<i>Paddle for mastitis test</i> .....	153
<i>Pepsin</i> .....	209
<i>Stethoscope</i> .....	114

# Index

<i>Pig holders</i> .....	84
<i>Pipette for rabbits semen measuring</i> .....	200
<i>Pipettes, aspirators for pipettes and automatic pipetes</i> .....	224
<i>Planing form farm control</i> .....	72
<i>Plastic bracelets for cattle identification</i> .....	79
<i>Plastic collars for sheep</i> .....	79
<i>Plastic seal</i> .....	78
<i>Pleximeter</i> .....	106
<i>Polyglycolic acid suture</i> .....	118
<i>PORKI REP pig calming spray</i> .....	46-50
<i>Povidone iodine Desinpov of 500ml</i> .....	115
<i>Probangs</i> .....	145
<i>Protecting head</i> .....	113
<i>Pump, dosing for medicines</i> .....	38
<i>Pump, digital dosing for medicines</i> .....	38
<i>Pump, peristaltic</i> .....	221
<i>Pump, programmable for peroxide</i> .....	38
<i>Pump, standard programmable</i> .....	38
<i>Pump, stomach</i> .....	145
<i>Psychrometers</i> .....	31
<i>PH meters</i> .....	31
<b>Q</b>	
<i>Quartz bulb economiser lamp-holder</i> .....	83
<i>Quartz reflectors, clear</i> .....	82
<i>Quartz reflectors, red</i> .....	82
<b>R</b>	
<i>Rabbit artificial insemination</i> .....	198 to 201
<i>Rabbit sperm dosage filling machine</i> .....	201
<i>Rabbit artificial vagina</i> .....	200
<i>Rabbit collector sheath</i> .....	200
<i>Rabbit semen tubes 5ml</i> .....	200
<i>Rattle paddle, flexible for livestock handling</i> .....	85
<i>Rattle paddle for livestock handling</i> .....	85
<i>Rattle paddle, "short" for livestock handling</i> .....	85
<i>Reagent liquid for California test</i> .....	153
<i>Refrigerators, fixed semen storage</i> .....	218 to 219
<i>Refrigerators, semen and vaccines carrying with compressor, 12V-220V</i> .....	220
<i>Refrigerators, semen and vaccines carrying 12V and idothermal bags</i> .....	220
<i>Refrigerators, with double pass-through doors for biosafety</i> .....	217
<i>Repellers, for birds</i> .....	45
<i>Repellers, for deers</i> .....	45
<i>Repellers, for moles and rats</i> .....	45
<i>Repellers, for rabbits</i> .....	45
<i>Repellers, for wilds pigs</i> .....	45
<i>Retractor, FARABEUF</i> .....	111
<i>Retractor, ROUX set</i> .....	111
<i>Retractor, VOLKMANN</i> .....	111
<i>Retractor, WEITLANER</i> .....	111
<i>Rodenticides</i> .....	44
<i>Ropes, prolapse for dairy cows</i> .....	110
<i>Ropes, long perlon, double loop</i> .....	109
<i>Ropes, long perlon, one loop</i> .....	109
<i>Ropes, sheep prolapse with fastening</i> .....	110
<i>Ropes, short perlon</i> .....	109
<i>Rubber docking rings</i> .....	49
<i>Rumenotomy kit</i> .....	112
<i>Rumial magnet introducer, flexible</i> .....	146
<i>Rumial magnet introducer, rigid</i> .....	146
<i>Rumial magnet, MEDVET super II white</i> .....	146
<i>Rumial magnet, STARVET, cage form</i> .....	146
<i>R.U.M. calming spray</i> .....	46
<b>S</b>	
<i>Safety glasses, 3M anti-fog</i> .....	92
<i>Safety glasses, 3M colorless ergonomic</i> .....	92
<i>Safety glasses, 3M ergonomic solar</i> .....	92
<i>Safety glasses, 3M visit, goggles</i> .....	92
<i>Sand rope carrier</i> .....	109
<i>Scales</i> .....	32-33-39-200

# Index

Scalpel blades .....	101
Scalpel handles .....	101
Scalpel, LINDE .....	110
Scanner gel, STARVET-SONIC .....	208
Scientific glass .....	222-225
Scissors .....	102-103
Scissors, IRIS .....	103
Scissors, JESCO .....	103
Scissors, LISTER bandage .....	103
Scissors, LITTAUER to suture removal .....	103
Scissors, MAYO-STILLE .....	103
Scissors, METZENBAUM .....	103
Scissors, SPENCER to suture removal .....	103
Scraper .....	125
Sheep and goat milking pump .....	151
Sheep shears .....	132
Sheaths .....	155
Shoulder protection .....	88
Shovels, dispending .....	39
Shovels, dispending with built-in scale .....	39
Sorting board for livestock handling (INSERBO) .....	85
Slides and slides cover .....	222
Slides dispenser .....	222
Sodium chloride .....	225
Speedy drencher bottle with probe and valve .....	152
SPLAYLEGSTOP self-adhesive, anti-splay tape to counteract splay leg in piglets .....	47
Squeegee .....	125
Straws .....	155
Straws defroster .....	155
Straw cutter .....	155
Stunners, pincers for sheeps .....	41
Stunners, portable with clamp for pigs .....	41
Staple extracting forceps (sterile) .....	116-119
Stereomicroscopes .....	212
Stomach pump .....	145
Stoves for drying, sterilization and cultives .....	213
Suture needles for veterinary use .....	120-121-122
Suture needle, Gerlach .....	124
Suture needle, prolapse BUHNER .....	124
Suture needle, REVERDIN .....	124
Suture stapler with 35 staples (sterile) .....	116-119
SUPRAMID .....	118-119
SUPRAMID WHITE, sterile cassette .....	119
Swabs for ears (cotton) .....	116
Swabs, sterile to obtain samples .....	238
Syringes, automatic oral drenching .....	182 to 190
Syringes, disposable .....	162-163
Syringes, DRENCHMATIC oral drenching .....	190
Syringes, ECO-MATIC vaccinators .....	186
Syringes, FERROMATIC vaccinators .....	186
Syringes for tuberculin injection, gun form .....	192
Syringes HAUPTNER for tuberculin injection, bayonet-type cone .....	192
Syringes HAUPTNER for tuberculin injection, gun form .....	192
Syringes, GROTEERMAN (without needle) .....	193-198
Syringes, GROTEERMAN AUTOMATIC (without needle) .....	198
Syringe, injection for rabbits artificial insemination .....	198-201
Syringes, intradermical .....	193 to 198
Syringes, hand oral drenching .....	189
Syringes, HAUPTNER revolver .....	180 to 183
Syringe, HAUPTNER vaccinator .....	182
Syringes, metal .....	181
Syringes, revolver .....	181
Syringes, ROUX revolver .....	184
Syringes, ROUX revolver with extension .....	184
Syringes, SERENA with extension .....	187
Syringes, STARVET adjustable .....	165
Syringes, STARVET at 1m distance .....	165
Syringes, STARVET battery vaccinators .....	171
Syringes, STARVET oral drenching .....	188-189
Syringes, STARVET plain .....	165

# Index

Syringe, STARVET Pour-on .....	188
Syringes, STARVET vaccinators .....	166 to 171
Syringes, SOCOREX vaccinators .....	176 to 179
Syringes, oral drenching .....	188 to 190
Syringes, PISTOLMATIC oral drenching .....	190
Syringes, pneumatic .....	172 to 175
Syringes, VET-MATIC vaccinators .....	186
Syringes, with straight cannula for rabbit A.I. ....	198-201
Syringes, without needle .....	173-184-193-199
<b>T</b>	
Tail bridle .....	142
Tail docker, electric .....	50-51
Tail docker, fixed with hands-free spacer .....	51
Tail docker, of gas .....	50
Tank, programmable mixing .....	38
Tape with velcro for cattle (nylon) .....	79
Tattoo accessories .....	54 to 61
Tattoo ink, food .....	59
Tattoo ink, for seized meat .....	59
Tattoo ink, liquid .....	61
Tattoo ink, roll-on system .....	58
Tattoo ink, to mark sheep .....	65
Tattooing forceps .....	55-56
Tattooing forceps, HAUPTNER .....	56
Tattooing forceps, rotary of 5mm and 6 spaces .....	56
Tattooing hammers, HAUPTNER .....	54
Tattooing hammers, of aluminium .....	54
Tattooing hammers, of zinc coated .....	54
Tattooing hammers with ink tank (INSERFIX) .....	60-61
Teat dilator, DR NAYLOR .....	153
Teat disinfectant bottle, Ambic, foaming action .....	154
Teat disinfectant bottle with water return .....	154
Teat disinfectant bottle without water return .....	154
Teat cannulas .....	153
Teat splitter, BARTELS .....	153
Teat cannula, Luer Lock .....	153
Teat cannula, olive type .....	153
Teat for lamb feeding bottle (red) .....	147
Teat for small animals .....	116
Teat splitter, DANISH .....	153
Teat splitter, HUG .....	153
Teat splitter, SWISS .....	153
Tendon clamp, close model and open model .....	141
Test tubes .....	239
Thermic cover for rabbits artificial vagina .....	200
Thermometers, ACCUVET Digi-temp (speed reading) .....	28
Thermometers, big room .....	27
Thermometers, digital veterinary .....	28
Thermometers, digital veterinary with flexible tip .....	28
Thermometers, digital veterinary large size .....	28
Thermometers, digital with external probe and with internal probe .....	30
Thermometers, for liquids .....	27
Thermometers, for liquids with plastic protection .....	27
Thermometers, for poultry .....	27
Thermometers, infrared .....	29
Thermometers, maximum and minimum .....	27
Thermometers, room .....	27
Thermometers, with computer connection .....	29
Thermometers, with spear .....	30
Thermometers, wide vet without ring .....	28
Tick remover .....	116
Toluene .....	222
Tooth cutting nipper .....	49
Tooth grinders .....	48
Transformer for carrying fridges .....	220
Trap, for beetles .....	42
Trap, for flies .....	42
Trap, for mices .....	43
Trap, for rats .....	43

# Index

<i>Trichinoscope with screen</i> .....	209
<i>Trocar, HAUPTNER with 2 cannulas</i> .....	145
<i>Trocar, metal handle</i> .....	145
<i>Trocar, plastic screw</i> .....	145
<i>Trocar, universal sheep (4 sizes in one set)</i> .....	145
<i>Trocar, wooden handle</i> .....	145
<i>Troller, of stainless steel for piglets treatment</i> .....	53
<i>Troller, for Milk stainless steel with pump, mixer and pasteuriser</i> .....	147
<i>Troller, for Milk with pump, mixer</i> .....	147
<i>Troller, for piglets treatment with two tanks for pneumatic syringues</i> .....	175
<i>Troller, for swine artificial insemination</i> .....	235
<i>Troller with two tanks of 10L for two pneumatic syringues</i> .....	174
<i>Trousers, disposable individually folded</i> .....	91
<i>TURBAIR air-assisted sprayer for vaccines 220V and 12V</i> .....	195
<i>TURBAIR 12V battery, 12V battery charger</i> .....	195
<i>TURBAIR bag with cable for batteries, 12V</i> .....	195

## U

<i>Udder colth 32x32 cm</i> .....	154
<i>Ultrasound scanner, FUTURE-1 portable with batteries</i> .....	204
<i>Ultrasound scanner, FUTURE-2 portable with batteries</i> .....	207
<i>Ultrasound scanner, FUTURE-WIFI</i> .....	206
<i>Ultrasound scanner, portable with battery and transrectal liner probe</i> .....	208
<i>Ultraviolet (UV) sterilizer</i> .....	213
<i>Umbilical clamp for piglets and lambs</i> .....	48

## V

<i>Vaccinator, "garrocha" 26ml</i> .....	195
<i>Vaccinator, "garrocha" handle, 3m</i> .....	195
<i>Vaccinator, "garrocha" spare needle</i> .....	195
<i>Vagina for artificial insemination rabbits</i> .....	200
<i>Vagina for artificial insemination rabbits (of silicon)</i> .....	200
<i>Vaginal and nasal speculum, HARTMANN</i> .....	108
<i>Vaginal and nasal speculum, KILLIAN</i> .....	108
<i>Vaginal closing</i> .....	109
<i>Vaginal closing, HAUPTNER complete</i> .....	109
<i>Vaginal needles</i> .....	109
<i>Vaginal speculum, POLANSKY</i> .....	108
<i>Vaginal speculum with illumination handle</i> .....	108
<i>Vaginal suture tape</i> .....	119
<i>Valve for lamb teat, aluminium</i> .....	147
<i>Valve for lamb teat, plastic</i> .....	147
<i>Velcro straps for piglets</i> .....	47
<i>Video cameras for microscope</i> .....	210
<i>Video camera for microscope with integrated monitor</i> .....	211
<i>Volumetric flasks</i> .....	225

## W

<i>Wagons for feed</i> .....	39
<i>Waterbaths, INSERBO stainless steel</i> .....	214
<i>Waterbaths, INSERBO plastic</i> .....	215
<i>Waterproof jacket and trouser set</i> .....	98
<i>Weighband for cattle and pig</i> .....	142
<i>Wheelbarrow (polyester)</i> .....	39
<i>Wheelbarrow, for cadavers</i> .....	40
<i>Wheelbarrow, for cadavers with batteries</i> .....	40
<i>Wipes, biodegradable wet for sows higiene</i> .....	228
<i>Wipes, disinfectant for veterinary instruments</i> .....	101
<i>Wipes, disinfectant wet for sows higiene</i> .....	228
<i>Wipes, udder disinfectant</i> .....	154
<i>Wire pig staples</i> .....	139
<i>Wire pig staples applicator</i> .....	139
<i>Wire pig staples applicator (HAUPTNER)</i> .....	139
<i>Wire pig staples applicator universal</i> .....	139
<i>Wire pig staples (HAUPTNER)</i> .....	139
<i>Wire rings, chromed</i> .....	139
<i>Wire rings, HAUPTNER large, niquel-plated</i> .....	119
<i>Wire rings, nickeled</i> .....	139
<i>Wire rings, plier for pig</i> .....	139



OSL®

REPOSICIÓN Y MANTENIMIENTO  
MATERIAL BÁSICO  
INSTALACIÓN Y MANTENIMIENTO  
EQUIPOS PARA LABORATORIO  
MATERIAL PARA LA INVESTIGACIÓN  
MATERIAL PARA LA PRODUCCIÓN



Polígono Ind. Torrefarrera C/ Ponent, 3  
TORREFARRERA - (Lleida)  
Tel. 973 750 313 Fax 973 751 712  
insebio@insebio.com  
www.insebio.com

# Termómetros Thermometers



**DG-100A**  
20 cm

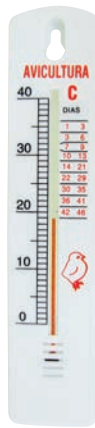

**DG-102**  
20 cm. Avicultura / Poultry

**Termómetro** de ambiente (varios modelos)  
*Room thermometer (several models)*



**DG-106**



**DG-105**

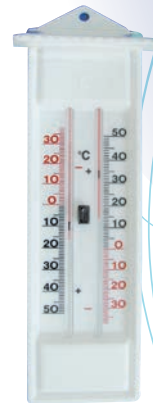

**DG-106A**

**Termómetro** de máxima y mínima  
**DG-105** digital con tejadillo  
**DG-106** digital tipo botón  
**DG-106A** Tipo botón ecológico

*Max and min thermometer*  
**DG-105** digital with canopy  
**DG-106** digital button type  
**DG-106A** Ecological button type



**DG-114** Pinza de sujeción para  
termómetros baño maría

**DG-114** Clip hold for liquid thermometers



**DG-101** Termómetro de ambiente  
de grandes dimensiones, para  
facilitar su visualización desde lejos

**DG-101** Big room thermometer  
*It is seen from a far distance*

**Alto: 40 cm**  
**Height: 40 cm**



**DG-118A** Termómetro para líquidos  
con protector de plástico, 120 °C

**DG-118A** Thermometer for liquids with plastic  
protection, 120 °C



**DG-115** Termómetro para líquidos de 100 °C  
**DG-116** Termómetro para líquidos de 150 °C  
**DG-117B** Termómetro para líquidos de 50 °C

**DG-115** Thermometer for liquids, 100 °C  
**DG-116** Thermometer for liquids, 150 °C  
**DG-117B** Thermometer for liquids, 50 °C



**DG-112A** Termómetro de veterinaria ancho sin anilla  
**DG-112** Termómetro de veterinaria ancho con anilla

*DG-112A* Wide veterinary **thermometer** without ring  
*DG-112* Wide veterinary **thermometer** with ring



**DG-111D** Termómetro de veterinaria digital, tamaño extragrande

*DG-111D* Digital veterinary **thermometer**, large size

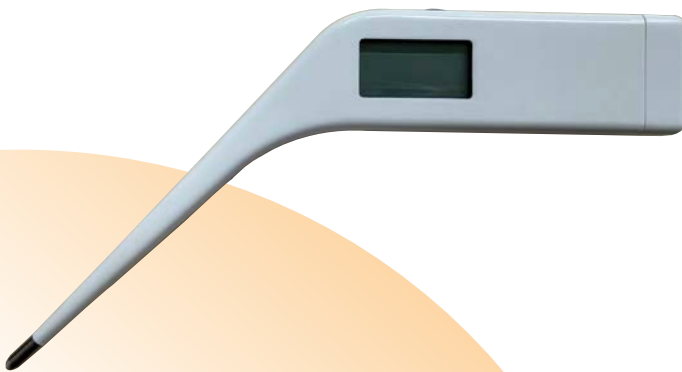

**DG-111DA** Termómetro de veterinaria digital, extragrande inclinado

*DG-111DA* Extra large tilted digital veterinary **thermometer**

**DG-111** Termómetro de veterinaria digital  
**DG-111A** Termómetro de veterinaria digital  
**DG-111B** Termómetro de veterinaria digital "punta flexible"

*DG-111* Digital veterinary **thermometer**  
*DG-111A* Digital veterinary **thermometer**  
*DG-111B* Digital veterinary **thermometer** with flexible tip



**DG-111**



**DG-111A**



**DG-111B**



**DG-111C** Termómetro de veterinaria digital ACCUVET - Digi-temp lectura rapida  
**DG-111CC** Termómetro de veterinaria digital (eco)

*DG-111C* Digi-temp digital veterinary **thermometer**  
*DG-111CC* Digital veterinary **thermometer**

# Termómetros Thermometers



**DG-111E** Termómetro de infrarrojos para animales (veterinaria)

*DG-111E Infrared thermometer for animals (veterinary)*



**DG-107 al DG-109** Detector de temperatura para conexión a ordenador, con programa para realizar gráficos, datos, etc. (varios modelos)

*DG-107 to DG-109 Temperature detector for computer connection, with programme to make graphics, data, etc (several models)*

Con la ventaja añadida de poder saber si en algún momento del día (hora y minutos exactos) la temperatura se ha modificado. Ideal para neveras, etc.

*With the advantage of being able to know if the temperature has changed at any time (exact time and minute) Ideal for conservation fridges etc.*



**DG-113** Termómetro de infrarrojos digital a distancia (blister)

*DG-113 Remote digital infrared thermometer (blister pack)*



**DG-113A** Termómetro de infrarrojos digital a distancia

*DG-113A Remote digital infrared thermometer*

Ideales para saber la temperatura, al momento, de cámaras frigoríficas, placas de calefacción, superficies, paredes, suelos, motores, equipos de refrigeración, calefacción, etc.

*Ideal for instantly temperature measuring of cold-storage rooms, heating plates, surfaces, walls, floors, engines, refrigeration equipment, heating, etc.*



**DG-109S** Detector-registrador de temperatura y humedad con USB integrado

*DG-109S USB temperature and humidity detector-logger*

**Termómetro con lanza**  
*Thermometer with spear*

**DG-119E** Digital 300 mm  
**DG-119G** 120 mm

**DG-119E**



**DG-119G**



**DG-103** Higrómetro de esfera de Ø130 mm  
**DG-103** Sphere *hygrometer*, Ø130 mm

**DG-103A** Higrómetro de esfera de Ø85 mm  
**DG-103A** Sphere *hygrometer*, Ø85 mm

**DG-113C** Higrómetro digital instantáneo de máx. y mín.

**DG-113C** Maximun and minimum digital instant *hygrothermometer*



**DG-119FG** Termómetro Deltatrak jumbo con lanza/sonda aguja

**DG-119G** Deltatrak jumbo *thermometer* with lance/needle probe



**DG-113D** Higrómetro digital tipo bolígrafo, máx. y mín.

**DG-113D** Pen-type digital max/min *hygrothermometer*



**DG-119B** Anemómetro digital

**DG-119B** Digital *anemometer*



**DG-119** Termómetro digital con sonda exterior Inox

**DG-119** Digital *thermometer* with external stainless steel probe



**DG-119A** Termómetro-higrómetro digital máx. y mín. con sonda interior

**DG-119A** Maximum and minimum digital *thermometer-hygrometer* with inner probe



**DG-119C** Termómetro-higrómetro digital máx. y mín. con sonda exterior

**DG-119C** Maximum and minimum digital *thermometer-hygrometer* with external probe

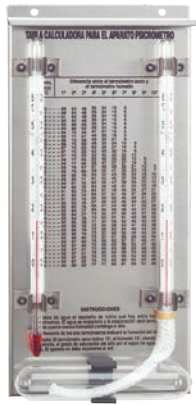

**DG-113G** Psicrómetro para medir humedad, de acero Inox

**DG-103G** Stainless steel *Psychrometer* to measure humidity



## Termómetros / Phmetros Thermometers / Phmeters

**DG-113F** Psicrómetro para medir humedad, de plástico

**DG-103F** Plastic *psychrometer* to measure humidity



**IA-280AB** Conductímetro con regulación automática de temperatura  
**IA-280AB** *Conductivity meter* with automatic temperature regulation



**IA-280AA** Phmetro portátil, waterproof con temperatura automática

**IA-280AA** Portable *PH meter* / Waterproof with automatic temperature

**DS-172** Kit reactivo para test de cloro y pH

**DS-172** Reagent *kit* for chlorine and pH test

**IA-280A** Phmetro portátil waterproof

**IA-280A** Portable waterproof *PH meter*



**IA-280T** Analizador de la pureza del agua "AQUATESTER"

**IA-280T** Water purity *analyzer* "AQUATESTER"

**Tiras reactivas indicadoras - Indicator test strips**

**DS-165** De cloro, tubo de 50 uds.

**DS-168** De dióxido de cloro, tubo de 50 uds

**DS-171** De peróxido, tubo de 50 uds

**DS-165** Chlorine, tube of 50 units

**DS-168** Chlorine dioxide, tube of 50 units

**DS-171** Chlorine Peroxide, tube of 50 units



**Cartuchos de humo**  
**Smoke cartridges**

**DG-170** Humo blanco, 75 seg. 8,5 m<sup>3</sup>, paq. 10 uds

**DG-171** Humo blanco, 180 seg. 17 m<sup>3</sup>, paq. 5 uds

**DG-172** Humo blanco, 150 seg. 55 m<sup>3</sup>, paq. 5 uds

**DG-173** Humo rojo, 180 seg. 17 m<sup>3</sup>, paq. 5 uds

**DG-170** White smoke, 75 sec. 8.5 m<sup>3</sup>, box of 10 pcs

**DG-171** White smoke, 180 sec. 17 m<sup>3</sup>, box of 5 pcs

**DG-172** White smoke, 150 sec. 55 m<sup>3</sup>, box of 5 pcs

**DG-173** Red smoke, 180 sec. 17 m<sup>3</sup>, box of 5 pcs



**DS-175** Medidor Checker de cloro y dióxido de cloro

**DS-185** Kit reactivo cloro libre de 0 a 2,5 MG/L (300 Test)

**DS-175** Chlorine and chlorine dioxide *Checker meter*

**DS-155** Free chlorine *reagent kit* for 0 to 2.5 MG/L (300 Test)



**IA-280Q** Indicador PH de 0-14, rollo 6 m

**IA-280Q** *PH indicator* roll (0-14), 6 m





**Dinamómetro para pesaje**

- IN-295** de 5 kg (grad. de 20 g)
- IN-300** de 10 kg (grad. de 50 g)
- IN-305** de 25 kg (grad. de 100 g)
- IN-310** de 50 kg (grad. de 200 g)
- IN-315** de 100 kg (grad. de 500 g)

**Dynamometer**

- IN-295** 5 kg (20 g accuracy)
- IN-300** 10 kg (50 g accuracy)
- IN-305** 25 kg (100 g accuracy)
- IN-310** 50 kg (200 g accuracy)
- IN-315** 100 kg (500 g accuracy)



**IN-348 Dinamómetro digital de 100 kg con precisión de 50 g**

**IN-348 Digital dynamometer 100 kg, 50 g accuracy**

**Dinamómetro digital para pesaje**  
**Digital dynamometer**



- IN-325** de 5 kg (precisión 5 g)
- IN-330** de 10 kg (precisión 10 g)
- IN-335** de 20 kg (precisión 20 g)
- IN-340** de 30 kg (precisión 20 g)
- IN-345** de 50 kg (precisión 50 g)

- IN-325** 5 kg (5 g accuracy)
- IN-330** 10 kg (10 g accuracy)
- IN-335** 20 kg (20 g accuracy)
- IN-340** 30 kg (20 g accuracy)
- IN-345** 50 kg (50 g accuracy)

**IN-350 Dinamómetro-báscula industrial digital de 1.000 kg**

**IN-350 Industrial digital dynamometer 1,000 kg**



**IB-740 Báscula móvil digital para pesar lechones en grupo, 1.000 kg**

**IB-740 Digital mobile scale to weigh piglets in group (1,000 kg)**

**IB-745 Báscula de 1.000 kg con soporte pantalla (150x76x6 cm)**

**IB-745 Scale with display support of 1,000 kg (150x76x6 cm)**



**IB-735 Báscula móvil digital de aluminio, 300 kg**

**IB-735 Digital aluminium mobile scale (300 kg)**



- IB-720 Báscula barras** pesaje 1,2mts de largo con display 1.000kg
- IB-721 Báscula barras** pesaje 1,2mts de largo con display 3.000kg

**IB-720 Bar scale weighing 1.2mts long with 1,000kg display**  
**IB-721 Bar scale weighing 1.2mts long with 3,000kg display**



# Dinamómetros / Básculas

## Dynamometers / Scales

### Báscula para pesaje de animales

**IB-730** Campo pesaje de 300 kg, lectura 200 g

**PA-600** Campo pesaje de 150 kg, lectura 100 g

- Plataforma de acero Inox de 90 cm de largo x 55 cm de ancho con alfombra de caucho antideslizante de serie.
- Pantalla digital con soporte mural
- Tara
- Auto-off para ahorro de energía
- Programa específico para el pesaje de animales
- Alimentación de 220 V con adaptador suministrado de serie o mediante 6 pilas AA de 1,5 V (no incluidas)
- Asidero y 2 ruedas para su fácil transporte



### Scale for animals

**IB-730** up to 300 kg (200 g reading)

**PA-600** up to 150 kg (100 g reading)

- Stainless steel platform 90 cm long x 55 cm wide, supplied with an anti-slippery rubber mat
- Digital display
- Tare
- Automatic shut down energy saver
- Specific program to weigh animals
- 220 V power supply (adaptor included) or by means of 6 AA 1.5V batteries (not included)
- Supplied with a handle and 2 wheels for an easy transportation

**IB-728** Báscula digital de 150 kgs plataforma de 40x30 cm

**IB-728** Digital scale of 150 kg platform of 40x30 cm



**Pesas de calibración** acero inox.  
Stainless steel **calibration weights**

**IA-299A** 1gr.

**IA-299C** 5 gr.

**IA-299B** 2 gr.

**IA-299D** 100 gr.



**IA-295** Báscula electrónica acero inox estanca, 15 kg, precisión 1 g

**IA-295** SS sealed **electronic scale**, 15 kg, 1 g accuracy



**IB-725** Báscula digital para pesar animales hasta 20 kg

**IB-725** Digital scale (up to 20 kg) for animals



**IA-294A** Báscula electrónica 2 kg, precisión 1 g

**IA-294A** Electronic scale (2 kg) 1 g accuracy

**Báscula digital de bolsillo**  
Digital pocket scale

**IA-298A** 500 g, precisión 0,1 g

**IA-298B** 250 g, precisión 0,1 g

**IA-298A** 500 g (0.1 g accuracy)

**IA-298B** 250 g (0.1 g accuracy)



**IA-294C** Báscula electrónica 6 kg, precisión 1 g

**IA-294C** Electronic scale (6 kg) 1 g accuracy

Disponemos de básculas desde 600 g, hasta 12 kg, con precisión de 1 g  
Scales from 600 g to 12 kg with 1 g accuracy available

**Bebederos pico pato acero Inox**  
Stainless steel *nipple drinkers*

**Bebederos**  
*Drinkers*



**IB-116**



**IB-115**



**IB-330**



**IB-325**



**IB-345**

- IB-115** hexagonal con filtro
- IB-116** normal con filtro
- IB-320** boca larga, 1/2"
- IB-320B** boca larga, 1/2" con filtro
- IB-330** 1/2" hexagonal boca larga
- IB-331** 1/2" (tapa azul)
- IB-325** hexagonal grande, 1/2"
- IB-345** hexagonal pequeño, 1/2"
- IB-376** para tolvas, rosca interior 3/8"

- IB-115* Hexagonal with filter
- IB-116* Normal with filter
- IB-320* 1/2" long mouth
- IB-320B* 1/2" long mouth with filter
- IB-330* 1/2" hexagonal (large mouth)
- IB-331* 1/2" (blue cap)
- IB-325* 1/2" hexagonal (big)
- IB-345* 1/2" hexagonal (small)
- IB-376* for feeders 3/8" , internal thread



**IB-331**



**IB-320**



**IB-320B**



**IB-376**



**IB-350**



**IB-355**

- IB-350** Bebedero pico pato latón hexagonal pequeño, 1/2"
- IB-355** Bebedero pico pato latón hexagonal, 1/2"

- IB-350* Brass 1/2" hexagonal *nipple drinker* (small)
- IB-355* Brass 1/2" hexagonal *nipple drinker*



IB-375A



IB-375



IB-370



IB-370A



IB-371



IB-379



IB-379A



IB-380

- IB-370 Bebedero humedecedor acero Inox para tolvas, 1/2"
- IB-370A Bebedero humedecedor acero Inox para tolvas, 1/2" (azul)
- IB-371 Bebedero humedecedor acero Inox para tolvas, 1/2" (azul) "1 Pieza"
- IB-375 Bebedero de acero Inox para tolvas, rosca interior de 3/8"
- IB-375A Bebedero de acero Inox para tolvas, rosca interior de 1/2"
- IB-379 Bebedero de acero Inox humedecedor lengüeta larga de 1/2"
- IB-379A Bebedero de acero Inox humedecedor lengüeta corta de 1/2"
- IB-380 Bebedero de acero Inox humedecedor de 1/2" (tapa azul)

- IB-370 1/2" stainless steel *nipple drinker* for feeders
- IB-370A 1/2" stainless steel *nipple drinker* for feeders (blue)
- IB-371 1/2" stainless steel *nipple drinker* for feeders (blue) "1 piece"
- IB-375 Stainless steel 3/8" *nipple drinker* for feeders
- IB-375A Stainless steel 1/2" *nipple drinker* for feeders
- IB-379 1/2" stainless steel *nipple drinker* humidifier with long pin
- IB-379A 1/2" stainless steel *nipple drinker* humidifier with short pin
- IB-380 1/2" stainless steel *nipple drinker* humidifier (blue cap)



IB-399 Conjunto de piezas y codos para salida doble para chupetes

IB-399 Set of parts and elbows for double outlet for pacifier

CHUPETES NO INCLUIDOS  
NIPPLE DRINKERS NOT INCLUDED

# Bebederos Drinkers



**IB-360**



**IB-365**



**IB-365A**



**IB-335**



**IB-378**

**IB-360 Bebedero** aspersor acero Inox con 3 agujeros, 1/2"

**IB-365 Bebedero** aspersor acero Inox con ranura, 1/2"

**IB-365A Bebedero** aspersor acero Inox con ranura, 1/2" (Tapa Azul)

**IB-335 Bebedero** tipo bola acero Inox de 1/2" hexagonal

*IB-360 Stainless steel sprinkler nipple drinker 1/2"*

*IB-365 Sprinkler nipple drinker with groove 1/2"*

*IB-365A Sprinkler nipple drinker with groove 1/2" (Blue cap)*

*IB-335 Stainless steel ball type nipple drinker 1/2" hexagonal*

**IB-378 Bebedero** de acero Inox para cazoleta, 1/2"

*IB-378 Stainless steel drinker for bowl, 1/2"*



**IB-600**

**IB-600 Bebedero** con protector 1/2"

**IB-605 Bebedero** sin protector 1/2"

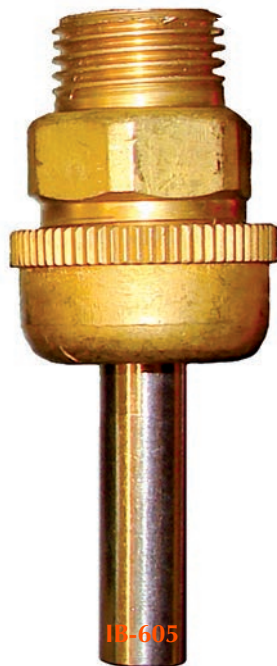

**IB-605**

*IB-600 1/2" Drinker with protection*

*IB-605 1/2" Drinker without protection.*



**IB-377**

**IB-377 Bebedero** de acero Inox para cazoleta, rosca interior de 1/2"

**IB-377A Bebedero** de acero Inox para cazoleta, rosca interior de 1/2" (Con filtro)

*IB-377 Stainless steel nipple drinker, 1/2" internal thread*

*IB-377A Stainless steel nipple drinker, 1/2" internal thread (with filter)*



**IB-377A**

**IB-615**

**IB-640**

**IB-635**



**IB-610**



**IB-625**



**IB-620**



**IB-630**

**IB-610** Boquilla Inox

**IB-615** Protector

**IB-620** Muelle

**IB-625** Varilla latón y plástico

**IB-630** Goma y arandela Inox

**IB-635** Tuerca latón

**IB-640** Cuerpo latón

*IB-610 Stainless steel mouthpiece*

*IB-615 Protection*

*IB-620 Spring*

*IB-625 Plastic and brass rod*

*IB-630 Washer and stainless steel plate*

*IB-635 Brass screw*

*IB-640 Brass body*

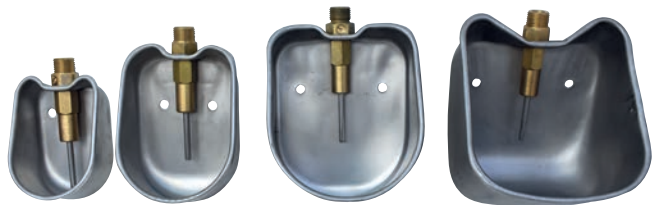

**Bebedero cazoleta de acero Inox**  
Stainless steel *bowl drinker*

- |  |                                     |
|--|-------------------------------------|
| <b>IB-220</b> Lechones maternidad nº 1 | <b>IB-220</b> Piglets maternity nº1 |
| <b>IB-225</b> Lechones destete nº 2    | <b>IB-225</b> Weaning Piglets nº2   |
| <b>IB-230</b> Engorde nº 3             | <b>IB-230</b> Fattening nº3         |
| <b>IB-235</b> Cerdas madres nº 4       | <b>IB-235</b> Mother sows nº4       |



**Bebedero porcino de acero Inox**  
Stainless steel *pig drinker*

- |                       |                      |
|-----------------------|----------------------|
| <b>IB-250</b> Grande  | <b>IB-250</b> Big    |
| <b>IB-255</b> Mediano | <b>IB-255</b> Medium |
| <b>IB-260</b> Pequeño | <b>IB-260</b> Small  |

**Bebedero aluminio pintado**  
Painted aluminum *drinker*

- |                              |                            |
|------------------------------|----------------------------|
| <b>IB-264</b> Transición     | <b>IB-264</b> Transition   |
| <b>IB-265</b> Cebo/Madres    | <b>IB-265</b> Bait/Mothers |
| <b>IB-266</b> Madres grandes | <b>IB-266</b> Big mothers  |



**IB-266**

**IB-265**

**IB-264**

**IB-185 Bebedero para ovejas completo con boya 10/100**

**IB-185** Sheep *drinker* with float 10/100



**IB-205 Bebedero vacuno de acero Inox con boya de 10/100**

**IB-205A Bebedero vacuno de acero Inox con boya de 3/8**

**IB-205B Bebedero vacuno de acero Inox con boya de 3/8 (animales pequeños)**

**IB-205** Stainless steel 10/100" cattle *drinker* with buoy

**IB-205A** Stainless steel 3/8" cattle *drinker* with buoy

**IB-205B** Stainless steel 3/8" cattle *drinker* with buoy (small animals)



**IB-204 Bebedero para vacuno vitrificado**

**IB-204** Vitrified cattle *drinker*



**IB-200 Bebedero para vacuno de acero Inox con lengüeta**

**IB-200** Cattle *drinker*, stainless steel



**IB-214A Bebedero grande alargado de 42 l (100x35x24cm)**

**IB-214 Bebedero grande alargado de 42 l con entrada de agua y flotador (100x35x24cm)**

**IB-214A** Large elongated *drinker* 42 l (100x35x24cm)

**IB-214** Large elongated *drinker* 42 l with water intel and buoy (100x35x24cm)



**IB-216 Bebedero basculante de acero Inox 89x40x17**

**IB-216** Stainless steel tilting *drinker* 89x40x17

# Bebederos / Comederos / Bombas / Palas Drinkers / Feeders / Pumps / Scoops



**IB-100 Bebedero** para medicar lechones con depósito de 5 l  
**IB-105 Bebedero** para medicar lechones sin depósito  
*IB-100 Drinker for piglets medication with a 5 l tank*  
*IB-105 Drinker for piglets medication without tank*



**IB-275 Bebedero** de plástico de 5,5 l  
**IB-280 Bebedero** de plástico de 12 l  
*IB-275 Plastic drinker 5.5 l*  
*IB-280 Plastic drinker 12 l*



**IB-455 Bomba dosificadora** para medicamentos, de 1% a 5%  
*IB-455 Dosing pump for medicines, 1% to 5%*



**IB-453 Bomba dosificadora** Aquablend 0,8% - 5%  
*IB-453 Aquablend Dosing pump 0,8% - 5%*



**IB-465 Depósito mezclador** programable de 120 l  
*IB-465 Programmable mixing tank, 120 l*



**Comedero 1ª edad** Inox para lechones  
*Stainless steel feeder for piglets*  
**IB-300** ⌀ 25x5cm de alto  
**IB-301** ⌀ 25x6cm de alto  
*IB-300* ⌀ 25x5cm high  
*IB-301* ⌀ 25x6cm high



**IB-305 Comedero** 1ª edad Inox para lechones, grande  
*IB-305 Stainless steel feeder for piglets (big model)*

## Bomba dosificadora digital / Digital dosing pump



**DS-150 Bomba dosificadora** digital para medicar  
*DS-150 Digital dosing pump to medicate*



**DS-140** programable para peróxido 220 v  
**DS-145** programable standard 220 v  
*DS-140 Programmable for peroxide 220 V*  
*DS-145 Standard programmable for 220 V*



**DS-141** programable para peróxido 12 v  
**DS-146** programable standard 12 v  
*DS-141 Programmable for peroxide 12 V*  
*DS-145 Standard programmable for 12 V*



**IB-812** Pala dispensadora de pienso galvanizada, 2 kg

**IB-812** Galvanised *dispensing shovel* 2 kg



**Pala dispensadora** de aluminio redonda  
*Round aluminum dispensing shovel*

- IB-825** 900 g
- IB-825A** 1.100 g
- IB-826** 1.600 g
- IB-827** 2.500 g

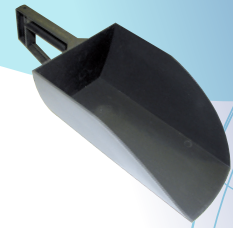

**Pala dispensadora** para pienso  
*Feed dispensing shovel*

- IB-810** 1 kg
- IB-811** 2 kg



**IB-815** Pala-jarra dispensadora sólidos-líquidos 2 l, 2 kg

**IB-815** Solid/liquid food scoop 2 l/2 kg



**IB-820** Pala dispensadora con báscula incorporada

**IB-820** Dispensing shovel with built-in scale



**IB-747** Vagoneta de 200 kg con báscula digital, 3 ruedas

**IB-747** 3 wheels Wagon with digital scale (200kg)



**Vagoneta para pienso poliéster**  
*Polyester wagon for feed*

- IB-871** 100 kg, 3 ruedas
- IB-885** 200 kg, 3 ruedas
- IB-880** 300 kg, 3 ruedas

**IB-871** 100 kg, 3 wheels  
**IB-885** 200 kg, 3 wheel  
**IB-880** 300 kg, 3 wheel



**Vagoneta para pienso poliéster**  
*Wagon for polyester feed*

- IB-870** 100 kg, 4 ruedas
- IB-875** 200 kg, 4 ruedas
- IB-890** 300 kg, 4 ruedas

**IB-870** 100 kg, 4 wheel  
**IB-875** 200 kg, 4 wheel  
**IB-890** 300 kg, 4 wheel



**IB-895** Carretilla poliéster extra-grande, 1 rueda 140 l

**IB-895** Extre-large polyester wheelbarrow, 1 wheel 140 l



**IB-865** Carretilla de bajas "a baterías" hasta 130 kg

*IB-865* Carcass **trolley** with batteries, up to 130 kg



**IB-867** Carretilla de bajas "a baterías" hasta 300 kg

*IB-867* Carcass **trolley** with batteries, up to 300 kg



**IB-868** Plataforma "TRANSPORKER" para bajas

*IB-868* "TRANSPORKER" **plataform** for carcass



**IP-113** Sacos negros grandes gruesos de 85x105 cm., caja de 180 u (para cadáveres, basura, etc)

*IP-113* Large thick **black bags** of 85x105 cm, box of 180 units (for corpses, garbage, etc.)



**IB-850** Carretilla de bajas standard  
**IB-855** Carretilla de bajas grande

*IB-850* Carcass **trolley**, standard  
*IB-855* Carcass **trolley**, large



**IB-863** Carretilla de bajas acero Inox con 2 ruedas, mediana

*IB-863* Stainless steel carcass **trolley** with 2 wheels, medium

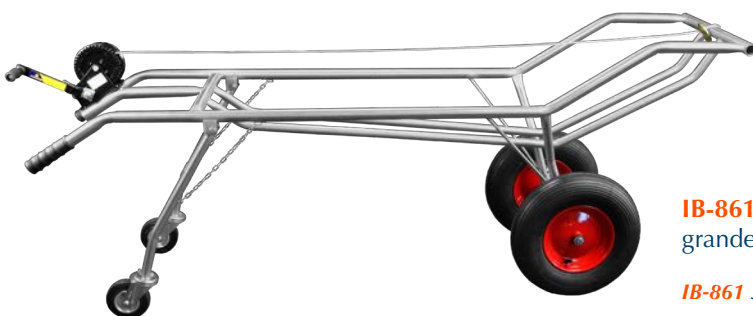

**IB-861** Carretilla de bajas acero Inox con 4 ruedas, grande

*IB-861* Stainless steel carcass **trolley** with 4 wheels, large

# Carretillas / Pistolas / Exterminadores

## Trolleys / Pistols / Exterminators



**IC-320** Cartucho para porcino y becerros (verde), paq. 50 uds

**IC-325** Cartucho para vacas y caballos (amarillo), paq. 50 uds

**IC-330** Cartucho para bueyes y toros (azul), paq. 50 uds

**IC-335** Cartucho para toros grandes (rojo), paq. 50 uds

**IC-320** Cartridge for pigs and calves (green), box of 50 units

**IC-325** Cartridge for cows and horses (yellow), box of 50 units

**IC-330** Cartridge for bulls (blue), box of 50 units

**IC-335** Cartridge for big bulls (red), box of 50 units

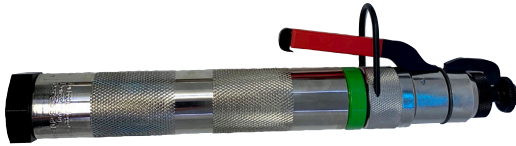

**IC-305** Pistola para sacrificio de lechones

**IC-305** Piglet slaughter gun

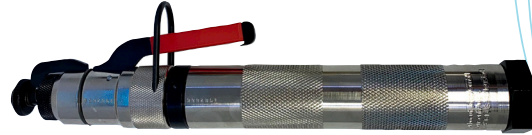

**IC-300** Pistola para sacrificio de animales

**IC-300** Animal slaughter gun



**IC-297** Pistola para sacrificios de conejos

**IC-297** Rabbit slaughter gun



**IC-298** varilla de descabello, paq. 25 uds

**IC-298** Pithing Rod, bag of 25 pcs



**IC-275** Aturdidor eléctrico portátil con pinza para porcino

**IC-275** Portable electric stunner with clamp for pigs

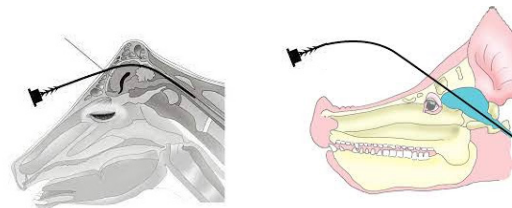

**IC-280** Pinza aturdidora para ovejas

**IC-280** Sheep stunning pincers



**Exterminador de insectos electrónico**  
*Electronic insect exterminator*

- II-150** para 30 m<sup>2</sup>                      *II-150 for 30 m<sup>2</sup>*
- II-155** para 120 m<sup>2</sup>                    *II-155 for 120 m<sup>2</sup>*
- II-157** para 160 m<sup>2</sup>                    *II-157 for 160 m<sup>2</sup>*
- II-160** para 200 m<sup>2</sup>                    *II-160 for 200 m<sup>2</sup>*



**RA-140** Expositor trampa para moscas, 12 uds

**RA-141** Trampa para moscas

*RA-140 Fly trap display, 12 pcs*

*RA-141 Fly trap*

**RA-155** Expositor trampa para moscas ventana, 6 paq. de 4 uds

**RA-156** Trampa para moscas ventana, paq. de 4 uds

*RA-155 Window fly trap display with 6 boxes of 4 pcs*

*RA-156 Window fly trap, box with 4 pcs*

**RA-145** Expositor trampa para cucarachas, 12 paq. de 2 uds

**RA-146** Trampa para cucarachas, paq. de 2 uds

*RA-145 Beetle trap display with 12 boxes of 2 pcs*

*RA-146 Beetle trap, box with 2 pcs*



**FENDONA**  
**RA-250** 1 l  
**RA-255** 0,5 l



**RA-180** Raqueta eléctrica matamoscas

*RA-180 Electronic fly-swat*

# Exterminadores Exterminators

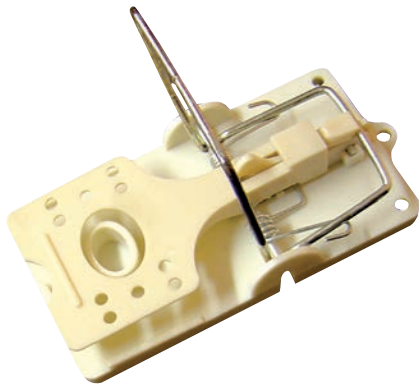

**RA-130** Trampa para ratas reforzada  
**RA-135** Trampa para ratones reforzada

*RA-130 Reinforced rattrap*  
*RA-135 Reinforced mice trap*



**RA-705** Auyentador doble de roedores con ultrasonidos para 400 m<sup>2</sup>

*RA-705 Double ultrasonic rodent repellent fr 400 m<sup>2</sup>o*

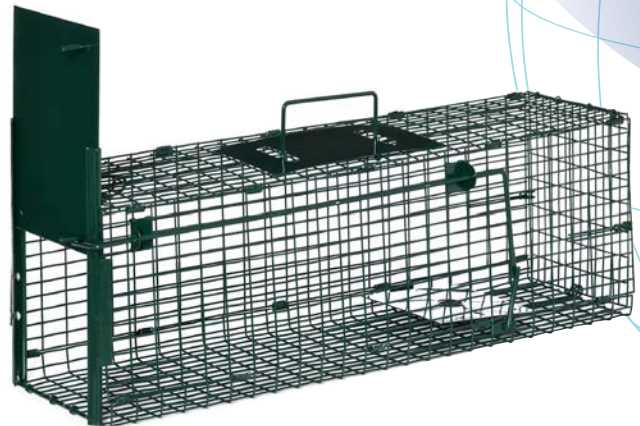

**IC-600** Jaula trampa de acero 75x25x25

*IC-600 Steel cage tramp 75x25x25*



**RA-120** Expositor de sobremesa SUPERCAT ratas, 12 uds

*RA-120 SUPERCAT rattrap counter display, 12 units*



**RA-110** Expositor de sobremesa SUPERCAT ratones, 14 cartas de 2 uds

*RA-110 SUPERCAT mousetrap counter display, 14 cards of 2 units*

**RA-105** Trampa para ratas SUPERCAT

*RA-105 SUPERCAT rattrap*



**RA-129** Trampa SUPERCAT para rata de jardín y topillo

*RA-129 SUPERCAT trap for garden rat and vole*

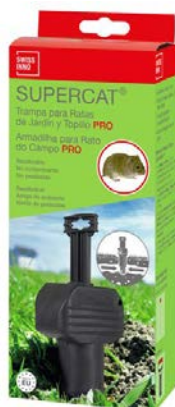

**RA-128** Jeringa de cebo natural SUPERCAT, paq. de 2 uds.

*RA-128 SUPERCAT natural bait syringe pack of 2 units*



**RA-100** Trampa para ratones SUPERCAT, carta de 2 uds

*RA-100 SUPERCAT mice trap, card of 2 units*



## Raticida Rodenticide



**RA-310** STORM ULTRA 300 gr (pastilla de 5gr)

**RA-310** STORM ULTRA 300 gr (5 gr tablet)



**RA-315** STORM ULTRA 3kg (pastilla de 5gr)

**RA-315** STORM ULTRA 3 kg (5 gr tablet)



**RA-320** STORM ULTRA 9kg (pastilla de 5gr)

**RA-320** STORM ULTRA 9 kg (5 gr tablet)



**RA-240** Estación raticida pequeña **STORM**

**RA-241** Estación raticida grande **STORM**

**RA-240** Small rodenticide station **STORM**

**RA-240** Large rodenticide station **STORM**

# Raticidas / Ahuyentadores Rodenticide / Repellers



**RA-640 Ahuyentador de conejos y liebres CUNIREP, 5 kg**

*RA-640 CUNIREP rabbit and hares repeller (5 kg)*

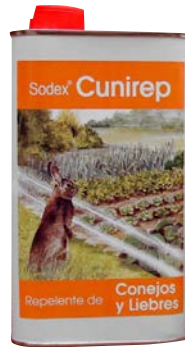

**RA-645 Ahuyentador de conejos para cuerdas CUNIREP, 1 l**

*RA-645 CUNIREP rabbit repeller for rope (1 l)*



**RA-650 Ahuyentador de conejos para cuerda CUNIREP, 200 m**

*RA-650 CUNIREP rabbit repeller for rope (200 m)*



**RA-630 Ahuyentador de jabalí RTA 50, 1 l**

**RA-652 Ahuyentador para conejos RTA 50, 1 l**

*RA-630 RTA 50 wild pig repeller (1 l)*

*RA-652 RTA 50 rabbit repeller (1 l)*



**RA-620 Spray Ahuyentador de topos y ratones TOPIREP, 650 ml**

*RA-620 TOPIREP mole and mice spray repeller (650 ml)*

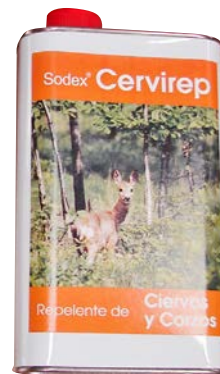

**RA-680 Ahuyentador de ciervos CERVIREP, 1 l**

*RA-680 CERVIREP deer repeller (1 l)*



**RA-685 Ahuyentador de ciervos CERVIREP, paq. de 50 bolsas**

*RA-685 CERVIREP deer repellent (pack of 50 pieces)*



**RA-655 Ahuyentador de pájaros ORNIREP, 1 l**

*RA-655 ORNIREP bird repeller (1 l)*



**RA-670 Ahuyentador de pájaros ORNIREP, paq. de 50 bolsas**

**RA-675 Ahuyentador de pájaros ORNIREP, paq. de 10 bolsas**

*RA-670 ORNIREP bird repeller (pack of 50 pieces)*  
*RA-675 ORNIREP bird repeller (pack of 10 pieces)*



**RA-760 Disuasor de aves de 5 kg, bolsas de 25 g**

**RA-765 Disuasor de aves de 1 kg, bolsas de 25 g**

*RA-760 Bird deterrent (5 kg - bags of 25 g)*  
*RA-765 Bird deterrent (1 kg - bags of 25 g)*



**RA-750 Disuasor de aves, 5 l**

**RA-755 Disuasor de aves spray manual, 750 ml**

*RA-750 Bird deterrent (5 l)*  
*RA-755 Bird manual spray deterrent (750 ml)*

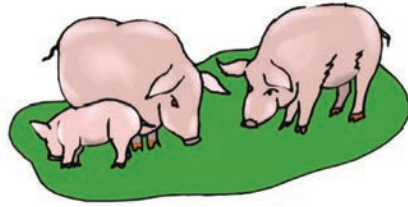

**RA-600 Spray tranquilizante de cerdos PORKIREP, 650 ml**

**RA-600 PORKIREP pig calming spray (650 ml)**

Calma a los cerdos y se muestra muy efectivo, evitando las peleas, y el canibalismo, en situación de stress, mezclas, hermanamientos, etc... y también aplicado durante la carga reduce la mortalidad de los animales durante el transporte al matadero.

En casos de estrés en cerdas, evita posibles casos de abortos.

Debido a su efecto preventivo, evita las peleas, mordeduras de colas, orejas, etc... i que se provoquen heridas

*It calms the pigs and is very effective, avoiding fights and cannibalism, in situations of stress, mixtures, twinning, etc... and also applied during loading reduces the mortality of animals during transport to the slaughterhouse.*

*In cases of stress in sows, it avoids possible cases of abortions.*

*Due to its preventive effect, it prevents fights, biting of tails, ears, etc... and avoiding injuries.*

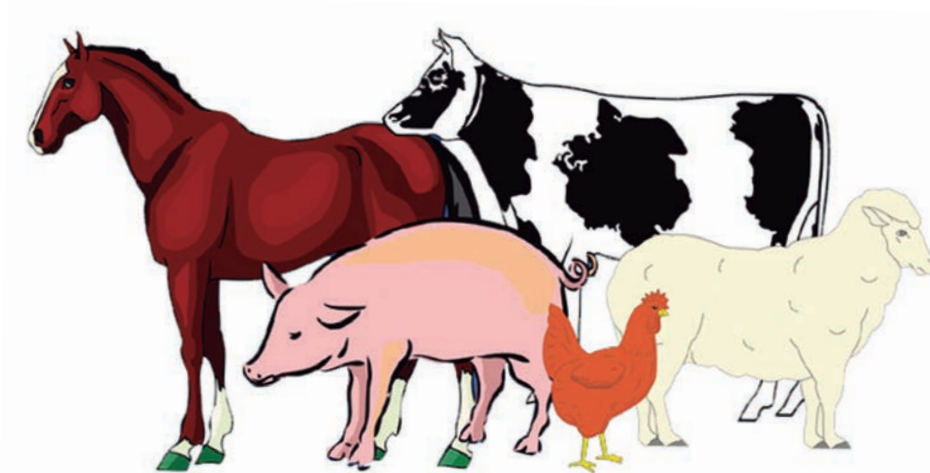

**RA-610 Spray tranquilizante R.U.M, 650 ml**

**RA-610 R.U.M. calming spray (650 ml)**



**IC-110A Spray manual anti-canibalismo, 500 ml**

**IC-110A Anticanibalism spray, 500 ml**

Spray extremadamente amargo para prevenir, controlar y evitar el canibalismo y mordeduras de colas en cerdos de engorde y lechones.

Posee una acción desinfectante y cicatrizante de secado rápido que reduce el sangrado en animales que ya han sido mordidos

*Extremely bitter spray to prevent, control and avoid cannibalism and prevent tail-biting in fattening pigs and piglets.*

*It has a quick-drying disinfectant and healing action that reduces bleeding in animals that have already been bitten.*

# Sprays / Pelotas / Carros

## Sprays / Balls / Trolleys



**IB-415** Cubo fun box colgable para bienestar animal

*IB-415 Hanging fun box cube for animal welfare*



**IB-414** Bola colgable especial para bienestar animal

*IB-414 Special hanging ball for animal welfare*



**IB-416** Tubo acero inox para morder materia orgánica

*IB-416 Stainless steel tube to bite organic matter*



**IB-400** Pelota antiestrés para porcino

*IB-400 Anti-stress ball for pigs*

**IB-400A** Pelota antiestrés para porcino completa con cadena-grillete para colgar

*IB-400A Anti-stress ball for pigs complete with chain-shackle for hanging*

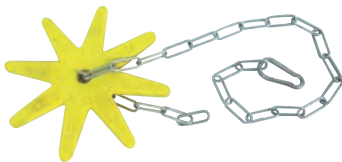

**IB-410** Estrella antiestrés para porcino con cadena-cierre completa

*IB-410 Anti-stress star for pigs (with chain and buckle)*



**IB-420** Juguete para lechones Easyfix Luna 86

*IB-420 Toy for piglets Easyfix Luna 86*



**IC-118C** SPLAYLEGSTOP para lechones, prevención patas abiertas, paq. 20 uds

*IC-118C SPLAYLEGSTOP Self-adhesive, anti-splay tape to counteract splay leg in piglets (20 pcs in a package)*



**IC-118A** Cinta velcro para lechones, paq. 12 uds

*IC-118A Velcro straps for piglets, 12 pcs bag*



**IN-122A** Bozal grande para cerdas

*IN-122A Sows big muzzle*



**IC-108AC** Lima dental INSERTO, de baterías extra con alargo

*IC-108AC INSERTO tooth grinder, with extra batteries and extension*



**IC-108AA** Lima dental con alargo INSERTO, 220 V

*IC-108AA INSERTO tooth grinder 220 V with extension*



**IC-108BB** Capuchón protector metálico lima dental parte alargo

*IC-108BB Metal protective cap tooth grinder extension part*



**IC-107** Punta lima dental de recambio

*IC-107 Spare file for tooth grinder*



**IC-117** Pinza umbilical para lechones y corderos

*IC-117 Umbilical clamp for piglets and lambs*

## Limas / Tenazas Grinders / Nippers



**IC-100 Tenaza** corta colmillos, acero Inox

**IC-100** Tooth cutting *nipper*, stainless steel



**IC-105 Tenaza** corta colmillos de acero Inox extra

**IC-105** Tooth cutting *nipper*, extra, stainless steel



**IC-104 Tenaza** corta colmillos HAUPTNER

**IC-104** HAUPTNER tooth cutting *nipper*



**IC-111 Tenaza** para gomas descolar

**IC-111** Rubber ring *applicator*



**IC-112 Tenaza** para gomas descolar, plástico

**IC-112** Rubber ring plastic *applicator*



**IP-215 Guantes** obstétricos porcino, 90 cm, bolsa de 5 unidades

**IP-215** Pig obstetric gloves, 90 cm, 5 units bag



**IC-116 Anillas de goma** para descolar, paq. de 100 uds  
**IC-115 Anillas de goma** para descolar, paq. de 500 uds

**IC-116** Rubber docking rings, bag of 100 units  
**IC-115** Rubber docking rings, bag of 500 units



**IC-122** Tubo recambio corta colas a gas

*IC-122 Spare tube for gas tail docker*



**IC-124** Gas para corta colas, 250 ml

*IC-124 Gas for tail docker 250 ml*



**IC-120** Corta colas de gas (se suministra con carga de gas), 250 ml

*IC-120 Gas tail docker (supplied with a 250 ml gas can)*



**IC-121** Cuchilla para corta colas

*IC-121 Spare Blade for tail docker*



**DS-850** Spray INTRA microderm de 250 ml

*DS-850 INTRA microderm spray 250 ml*



**IC-174** Cuchilla para corta colas eléctrico

*IC-174 Spare blade for electrical tail docker*



**IC-170** Corta colas eléctrico

*IC-170 Electrical tail docker*



**RA-600** Spray tranquilizante de cerdos PORKIREP, 650 ml

*RA-600 PORKIREP pig calming spray, 650 ml*



**IC-110A** Spray manual anti-canibalismo, 500 ml

*IC-110A Anticanibalism spray, 500 ml*



**IC-110** Spray anti-cannibalismo, 400 ml

*IC-110 Anticanibalism spray, 400 ml*

# Corta colas Tail-dockers



**IC-181** Corta colas eléctrico con carcasa y cuchilla con forma de media luna (IC-175A)

*IC-181 Electric tail docker with casing, crescent-shaped blade (IC-175A)*



**IC-180** Corta colas eléctrico con carcasa y cuchilla en forma de "M" (IC-175)

*IC-180 Electric tail docker with casing, blade "M" (IC-175)*



**IC-186** Cuchilla de recambio para corta colas, "V"

*IC-186 Spare blade for tail docker, "V"*



**IC-175** Cuchilla de recambio para corta colas, "M"

*IC-175 Spare blade for tail docker, "M"*



**IC-185A** Corta colas eléctrico sin carcasa y cuchilla en forma de "V" (IC-186)

*IC-185A Electric tail docker without casing, "V" blade (IC-186)*



**IC-185** Corta colas eléctrico sin carcasa y cuchilla plana (IC-187)

*IC-185 Electric tail docker without casing, flat blade (IC-187)*



**IC-175A** Cuchilla de recambio para corta colas, media luna

*IC-175A Spare blade for tail docker, with crescent-shaped*



**IC-187** Cuchilla de recambio para corta colas, plana

*IC-187 Spare blade for tail docker, flat*



**IC-185C** Corta colas eléctrico sin carcasa, cuchilla en forma de media luna (IC-175A)

*IC-185C Electric tail docker without casing, crescent-shaped blade (IC-175A)*



**IC-185B** Corta colas eléctrico sin carcasa y cuchilla en forma de "M" (IC-175)

*IC-185B Electric tail docker without casing, "M" blade (IC-175)*



**IC-183** Corta colas fijo con distanciador manos libres  
**IC-184** Corta colas fijo con distanciador y potenciómetro

*IC-183 Fixed tail docker with hands-free spacer  
IC-184 Fixed tail docker with potentiometer*



**IC-184A** Soporte para corta colas fijo, manos libres

*IC-184A Support for fixed tail docker*



**IC-133 Emascador** doble boca para caballos REIMERS, 31 cm

*IC-133 Reimers horse emasculator, 31 cm double mouth*



**IC-125 Emascador** recto HAUSSMAN, 19 cm

**IC-131 Emascador** recto HAUSSMAN, 27 cm

*IC-125 Haussman emasculator, 19 cm straight*

*IC-131 Haussman emasculator, 27 cm straight*



**IC-130 Emascador** curvo HAUSSMAN, 19 cm

**IC-131A Emascador** curvo HAUSSMAN, 27 cm

*IC-130 Haussman emasculator, 19 cm curved*

*IC-131A Haussman emasculator, 27 cm curved*



**Burdizo articulado**  
*Articulated castrator*

**IC-220** 30 cm

**IC-223** 34 cm

**IC-225** 40 cm

**IC-230** 48 cm



**IC-132 Emascador** para caballos VERBOCZY, 27 cm

*IC-132 VERBOCZY horse emasculator, 27 cm*



**IC-215 Burdizo articulado** para castrar metálico, 23 cm

*IC-215 Metallic articulated castrator, 23 cm*



**IC-133K Pinza-Forceps** para castración porcino con hoja nº24

*IC-133K Castration forceps for pigs with 24 size blade*



**IC-132A Emascador SERRA** de 31 cm

*IC-132A SERRA emasculator, 31 cm*



**IC-243 Separador retractor** para caponaje de aves de 19 cm

*IC-243 19 cm retractor for poultry castration*



**IC-242 Polipotomo** para castración de aves

*IC-242 Polipotom for poultry castration*

## Emasculadores / Potros Emasculators / Castration devices



**IC-205** Potro para castración de lechones standard

*IC-205 Standard castrating table for piglets*



**IC-200** Potro para castración de lechones (tipo asiento)

*IC-200 Castrating table for piglets*



**Potro para castración** acero Inox, con soporte  
*Piglet castration device*

**IC-190** Lechones de 2 a 9 días

*IC-190 from 2 to 9 days*



**IC-118B** Pinza-alargo recoge lechones tipo revólver de 80 cm

*IC-118B Revolver-type piglet claw of 80 cm*



**IB-847** Caja para transportar utensilios en ganadería

*IB-847 Box to transport utensils in livestock*



**IB-845** Cubeta de plástico con asa para llevar instrumentos, gris (reforzada)

**IB-846A** Cubeta de plástico para instrumentos, azul

*IB-845 Plastic tray, grey (reinforced)*

*IB-846A Plastic tray, blue*



**IA-669A** Carro-mesa para tratamiento de lechones, en acero Inox

*IA-669A Piglets treatment trolley stainless steel*

**NO INCLUYE POTRO NI CORTA COLAS**  
Castration devices not included

**Potro para trabajos en lechones**  
*Piglet castration device*

**IC-190** De 2 a 9 días

*IC-190 2 to 9 days*

**ID-098 Martillo** de 6 casillas HAUPTNER, sin accesorios

*ID-098 HAUPTNER tattooing hammer; 6 divisions. Without accessories*



**Martillo** doble fila HAUPTNER, sin accesorios  
*HAUPTNER tattooing hammer, double row, without accessories*

**ID-098A** de 8 casillas

*ID-098A 8 divisions*

**ID-098B** de 12 casillas

*ID-198B 12 divisions*

**ID-098C** de 14 casillas

*ID-198C 14 divisions*



**Martillo** de aluminio, sin accesorios

*Aluminium tattooing hammer, without accessories*

**ID-097** de 6 casillas

*ID-097 6 divisions*

**ID-097A** de 7 casillas

*ID-097A 7 divisions*

**ID-103D** de 8 casillas

*ID-103D 8 divisions*

**ID-103F** de 10 casillas

*ID-103F 10 divisions*



**Martillo** de aluminio doble fila, sin accesorios

*tattooing hammer with double row, aluminium, without accessories*

**ID-103B** de 10 casillas

*ID-103B 10 divisions*

**ID-103C** de 8 casillas

*ID-103C 8 divisions*

**ID-103E** de 14 casillas

*ID-103E 14 divisions*

**ID-103G** de 12 casillas

*ID-103G 12 divisions*



**Martillo** de hierro zincado

*Zinc coated tattooing hammer*

**ID-096** de 4 casillas

*ID-096 4 divisions*

**ID-096A** de 5 casillas

*ID-096A 5 divisions*

**ID-096B** de 6 casillas

*ID-096B 6 divisions*

**ID-096C** de 7 casillas

*ID-096C 7 divisions*

**ID-096D** de 8 casillas

*ID-096D 8 divisions*



**Martillo** de hierro zincado, doble fila

*Zinc coated hammer, double row*

**ID-096E** de 8 casillas

*ID-096E 8 divisions*

**ID-096F** de 10 casillas

*ID-096F 10 divisions*

**ID-096G** de 12 casillas

*ID-096G 12 divisions*

**ID-096H** de 14 casillas

*ID-096H 14 divisions*





**Tatuadora lineal** HAUPTNER, sin accesorios  
*HAUPTNER linear tattooing forceps without accessories*

**ID-191** 5 mm, 7 casillas      **ID-191** 5 mm, 7 divisions  
**ID-192B** 7 mm, 7 casillas      **ID-192B** 7 mm, 7 divisions



**ID-192A** Tatuadora de 5 mm, 4 casillas HAUPTNER

**ID-192A** HAUPTNER tattooing forceps 5 mm, 4 divisions



**Tatuadora** HAUPTNER, sin accesorios  
*HAUPTNER tattooing forceps, without accessories*

**ID-192** 7 mm, 7 casillas      **ID-192** 7mm, 7 divisions  
**ID-189** 7 mm, 9 casillas      **ID-189** 7mm, 9 divisions



**ID-195** Tatuadora de 10 mm, 5 casillas sin accesorios HAUPTNER  
**ID-198** Tatuadora de 10 mm, 5 casillas  
**ID-205** Tatuadora de 15 mm, 5 casillas sin accesorios HAUPTNER

**ID-195** HAUPTNER tattooing forceps 10 mm, 5 divisions, without accessories  
**ID-198** tattooing forceps 10 mm, 5 divisions  
**ID-205** HAUPTNER tattooing forceps 15 mm, 5 divisions, without accessories



**ID-190** Tatuadora de 14 casillas, sin accesorios, 7 mm

**ID-190** 7 mm tattooing forceps, 14 divisions without accessories



**ID-188C** Caracteres para tatuadora de 14 casillas, 7 mm

**ID-188C** 7 mm symbol for tattooing forceps, 14 divisions



**ID-193A** Tatuadora articulada, 10 mm de 5 casillas doble fila

*ID-193A 10 mm articulated **tattooing forceps**, double row, 5 divisions*

**ID-194** Tatuadora articulada de 10 mm de 6 casillas HAUPTNER

*ID-194 HAUPTNER **tattooing forceps** 10 mm, 6 divisions articulated*



**ID-193** Tatuadora articulada de 10 mm de 6 casillas doble fila HAUPTNER

*ID-193 HAUPTNER **tattooing forceps** 10 mm, double row 6 divisions, articulated*



**ID-191A** Tatuadora rotativa de 5 mm y de 6 caracteres

**ID-191B** Carácter para tatuadora rotativa de 5 mm

*ID-191A 5 mm and 6 spaces **rotary tattooer***

*ID-191B 5 mm **characters** for rotatory tattooer*



## MARTILLOS Y TATUADORAS HAMMERS AND TATTOOING FORCEPS

### Casillas lineales Linear rows

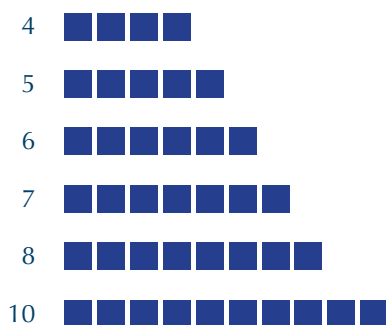

### Casillas dobles Double rows

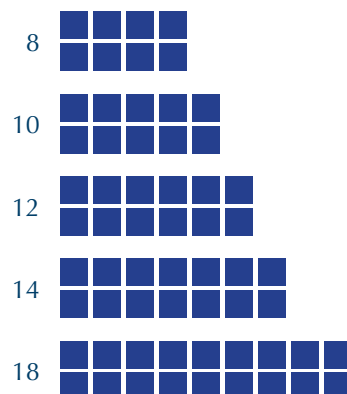

### Números y letras para martillo de 20 mm

*Numbers and letters for 20 mm tattooing hammer*

- ID-101** Juego de números *ID-101 Set of numbers*  
**ID-101A** hasta **ID-101J** Números sueltos *ID-101A to ID-101J single digits*  
**ID-102** Abecedario *ID-102 Complete alphabet*  
**ID-102A** hasta **ID-102Z** Letras sueltas *ID-102A to ID-102Z single letters*  
**ID-099** Placa lisa *ID-099 Blank plate*



### Números y letras para tatuadora de 15 mm

*Numbers and letters for 15 mm tattooing forceps*

- ID-155** letras *ID-155 Letters*  
**ID-175** Números *ID-175 Numbers*  
**ID-115** Abecedario *ID-115 Complete alphabet*  
**ID-135** Juego de números *ID-135 Set of numbers*



### Números y letras para tatuadora de 20 mm

*Numbers and letters for 20 mm tattooing forceps*

- ID-160** letras *ID-160 Letters*  
**ID-180** Números *ID-180 Numbers*  
**ID-120** Abecedario *ID-120 Complete alphabet*  
**ID-140** Juego de números *ID-140 Set of numbers*



### Números y letras para tatuadora de 10 mm

*Numbers and letters for 10 mm tattooing forceps*

- ID-130** Juego de números *ID-130 Set of numbers*  
**ID-170A** hasta **ID-170J** Números sueltos *ID-170A to ID-170J single digits*  
**ID-110** Abecedario *ID-110 Complete alphabet*  
**ID-150A** hasta **ID-150Z** Letras sueltas *ID-150A to ID-150Z single letters*  
**ID-183** Placa lisa *ID-183 Blank plate*



### Números y letras para tatuadora de 7 mm

*Numbers and letters for 7 mm tattooing forceps*

- ID-107** Abecedario *ID-107 Complete alphabet*  
**ID-147A** hasta **ID-147Z** Letras sueltas *ID-147A to ID-147Z single letters*  
**ID-167A** hasta **ID-167J** Números sueltos *ID-167A to ID-167J single digits*  
**ID-127** Juego de números *ID-127 Set of numbers*  
**ID-184** Placa lisa *ID-184 Blank plate*



### Números y letras para tatuadora de 5 mm

*Numbers and letters for 5 mm tattooing forceps*

- ID-106** Abecedario *ID-106 Complete alphabet*  
**ID-144A** hasta **ID-144Z** Letras sueltas *ID-144A to ID-144Z single letters*  
**ID-166A** hasta **ID-166J** Números sueltos *ID-166A to ID-166J single digits*  
**ID-126** Juego de números *ID-126 Set of numbers*



### **ID-145A** hasta **ID-145Z** Letras sueltas de 5 mm para tatuadora de 10 mm

- ID-105** Abecedario de 5 mm para tatuadora de 10 mm  
**ID-125** Juego de números 5 mm para tatuadora de 10 mm

*ID-145A to ID-145Z 5 mm single letters for 10 mm tattooing forceps*  
*ID-105 Complete alphabet, 5 mm for 10 mm tattooing forceps*  
*ID-125 5 mm numbers set for 5 mm tattooing forceps*





**ID-229** Frasco de tinta verde HAUPTNER, 600 g

**ID-230** Frasco de tinta negra HAUPTNER, 600 g

**ID-229** HAUPTNER green *tattooing paste pot*, 600 g

**ID-230** HAUPTNER black *tattooing paste pot*, 600 g



**ID-231** Frasco de tinta negra RAIDEX, 600 g

**ID-232** Frasco de tinta verde RAIDEX, 600 g

**ID-231** RAIDEX black *tattooing paste pot*, 600 g

**ID-232** RAIDEX green *tattooing paste pot*, 600 g



**ID-226** Tubo de tinta, sistema bola RAIDEX, negra

**ID-226** RAIDEX black *ink tube*, roll-on



**ID-225** Tubo de tinta, sistema bola HAUPTNER, negra

**ID-225** HAUPTNER black *ink tube*, roll-on



**ID-227** Tubo de tinta, sistema bola RAIDEX, verde

**ID-227** RAIDEX green *ink tube*, roll-on



**Tubo de tinta RAIDEX de 60 g**  
**Tattooing paste tube RAIDEX, 60 g**

**ID-221** Negra

**ID-222** Verde

**ID-223** Blanca

**ID-221** Black

**ID-222** Green

**ID-223** White



**Tubo de tinta HAUPTNER de 60 g.**  
**Tattooing paste tube HAUPTNER 60 g**

**ID-220** Negra

**ID-219** Verde

**ID-220** Black

**ID-219** Green



**ID-232A** Tinta líquida negra para tatuar HAUPTNER, 1 l

**ID-232A** HAUPTNER *tattooing fluid ink*, black 1 l



**ID-233** Tinta líquida negra para tatuar RAIDEX, 1 l

**ID-233** RAIDEX *tattooing fluid ink*, black 1 l

# Identificación Identification



**Tinta alimentaria** para marcar carne, 1 l  
*Meat stamping ink, 1 l*

- ID-297** Color rojo
- ID-298** Color azul
- ID-299** Color marrón

- ID-297** Red
- ID-298** Blue
- ID-299** Brown



**Tinta alimentaria** para marcar carne, 5 l  
*Meat stamping ink, 5 l*

- ID-297A** Color rojo
- ID-297B** Color azul
- ID-298A** Color marrón

- ID-297A** Red
- ID-297B** Blue
- ID-298A** Brown



**Tinta alimentaria RAIDEX** para marcar carne, 1 l  
*RAIDEX meat stamping ink, 1 l*

- ID-296A** Color rojo
- ID-296B** Color azul
- ID-296** Color marrón

- ID-296A** Red
- ID-296B** Blue
- ID-296** Brown



**Tinta alimentaria RAIDEX** para marcar carne, 5 l  
*RAIDEX meat stamping ink, 5 l*

- ID-296D** Color rojo
- ID-296E** Color azul
- ID-296C** Color marrón

- ID-296D** Red
- ID-296E** Blue
- ID-296C** Brown



**ID-234** Tampón para tinta de números manuales  
**ID-233T** Esponja de recambio para tampón de tinta

- ID-234** Ink pad for manual digits
- ID-233T** Spare sponge for ink pad



**ID-299A** Tinta para carne decomisada, azul, bidón de 5 l

- ID-299A** SRM blue dye solution, 5 l

# NOVEDAD GLOBAL

## El único martillo en el mundo con la tinta incorporada

*The only tattoo hammer in the world  
with ink cartridge*



## Marca un camión con tan solo una carga de tinta

*Marks full truck with just one load of ink*

# WORLD NOVELTY

Identificación  
Identification

## Marca y tatúa en el mismo instante en que golpea

*It tattoos instantly by hammering the animal, easy to use and clean*

**ID-100** Martillo tatuador INSERFIX con depósito de tinta

**ID-100** INSERFIX tattooing hammer with ink tank



Números para martillo tatuador INSERFIX exclusivos  
*Single digits for INSERFIX tattooing hammer*

**ID-100A** Números de 20 mm  
**ID-100B** Letras de 20 mm  
**ID-100C** Placa en blanco de 20 mm

**ID-100A** 20 mm single digits  
**ID-100B** 20 mm single letters  
**ID-100C** Blank plate for 20 mm



**ID-233C** Tinta líquida para tatuar alimentaria marrón, 1 l

**ID-233C** Tattooing fluid ink - brown (1 l)



**ID-233D** Tinta líquida para tatuar alimentaria marrón, 5 l

**ID-233D** Tattooing fluid ink - brown (5 l)



**ID-100F** Tampón para martillo tatuador INSERFIX, paquete de 10 unidades

**ID-100F** INSERFIX tattooing hammer pad, pack of 10 units

**Lápices para marcar RAIDEX, con rosca (caja de 10 u)**

*RAIDEX marking sticks, plastic tube with screw bottom*

- |                        |                      |
|------------------------|----------------------|
| <b>ID-280</b> Rojo     | <i>ID-280 Red</i>    |
| <b>ID-281</b> Azul     | <i>ID-281 Blue</i>   |
| <b>ID-282</b> Verde    | <i>ID-282 Green</i>  |
| <b>ID-283</b> Amarillo | <i>ID-283 Yellow</i> |
| <b>ID-284</b> Violeta  | <i>ID-284 Violet</i> |
| <b>ID-285</b> Naranja  | <i>ID-285 Orange</i> |
| <b>ID-286</b> Negro    | <i>ID-286 Black</i>  |
| <b>ID-287</b> Blanco   | <i>ID-287 White</i>  |



**Spray para marcar RAIDEX, 400 ml**  
*RAIDEX marking spray, 400 ml*

- |                         |                       |
|-------------------------|-----------------------|
| <b>ID-250</b> Rojo      | <i>ID-250 Red</i>     |
| <b>ID-255</b> Azul      | <i>ID-255 Blue</i>    |
| <b>ID-260</b> Verde     | <i>ID-260 Green</i>   |
| <b>ID-260A</b> amarillo | <i>ID-260A Yellow</i> |
| <b>ID-260B</b> violeta  | <i>ID-260B Violet</i> |

**Spray para marcar RAIDEX, 500 ml**  
*RAIDEX marking spray, 500 ml*

- |                     |
|---------------------|
| <b>ID-261</b> Rojo  |
| <b>ID-262</b> Azul  |
| <b>ID-263</b> Verde |
| <b>ID-264</b> Negro |

- |                     |
|---------------------|
| <i>ID-261 Red</i>   |
| <i>ID-262 Blue</i>  |
| <i>ID-263 Green</i> |
| <i>ID-264 Black</i> |



**Spray para marcar ovejas RAIDEX, 500 ml**  
*RAIDEX sheep marking spray, 500 ml*

- |                        |                       |
|------------------------|-----------------------|
| <b>ID-270</b> Rojo     | <i>ID-270 Red</i>     |
| <b>ID-271</b> Azul     | <i>ID-271 Blue</i>    |
| <b>ID-272</b> Verde    | <i>ID-272 Green</i>   |
| <b>ID-273</b> Negro    | <i>ID-273 Black</i>   |
| <b>ID-274</b> Amarillo | <i>ID-274 Yellow</i>  |
| <b>ID-275</b> Violeta  | <i>ID-275 Violet</i>  |
| <b>ID-275A</b> Rosa    | <i>ID-275A Pink</i>   |
| <b>ID-275B</b> Naranja | <i>ID-275B Orange</i> |

# Identificación Identification



**Lápices para marcar INSERTIX,**  
con rosca (caja de 12 u.)  
*INSERTIX marking sticks, plastic tube*  
with screw bottom

**ID-276** Rojo  
**ID-277** Azul  
**ID-278** Verde

*ID-276* Red  
*ID-277* Blue  
*ID-278* Green



**ID-269** Pistola para spray de marcar

*ID-269* Marking spray applicator



**Spray para marcar INSERTIX,** 400 ml  
*INSERTIX marking spray,* 400 ml

**ID-247** Rojo

**ID-248** Azul

**ID-249** Verde

**ID-249B** Negro

**ID-249F** Amarillo fluorescente

*ID-247* Red

*ID-248* Blue

*ID-249* Green

*ID-249B* Black

*ID-249F* Fluorescent yellow

**Alargo INSERTIX para sprays de marcar**  
*INSERTIX extension for marking spray*

**ID-269A** 100cm

**ID-269B** 50cm

**ID-269C** Realizado a medida

*ID-269A* 100 cm

*ID-269B* 50 cm

*ID-269C* Size by request

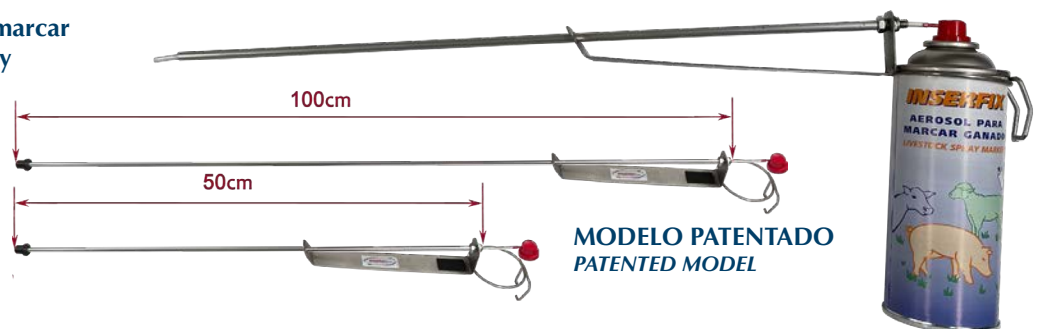

**MODELO PATENTADO**  
*PATENTED MODEL*



**ID-289** Alargo de 1 m para lápices de marcar "lineal"

**ID-289A** Alargo transversal para lápices de marcar, 1 m

*ID-289* Linear extension for markings sticks 1 m

*ID-289A* Extension for marking sticks, transversal 1 m





**Juego de números de aluminio** con mango de madera  
*Set of aluminium numbers with wooden handle*

- ID-234A** 8 cm
- ID-234B** 10 cm
- ID-234C** 12 cm



**ID-340** **Juego de números** de bronce de 8 cm para marcar a nitrógeno

*ID-340 Set of 8 cm bronze numbers to mark with nitrogen*



**ID-345** **Juego de números** para nitrógeno HAUPTNER

*ID-345 HAUPTNER set of numbers to mark with nitrogen*



**Lápiz para marcaje** de carne, caja de 12 uds  
*Meat marking pen, box of 12 units*

- ID-299B** Marrón      **ID-299B** Brown
- ID-299C** Azul        **ID-299C** Blue

**Tiza para marcaje** Sisa RAIDEX, caja de 12 uds  
*Sisa RAIDEX marking chalks, box of 12 pcs*

- ID-289B** Rojo            **ID-289B** Red
- ID-289C** Azul           **ID-289C** Blue
- ID-289D** Verde        **ID-289D** Green
- ID-289E** Amarillo      **ID-289E** Yellow



# Identificación Identification



## Tinta para marcar ovejas *Sheep marking ink*

**ID-234D** color rojo de 4 kg  
**ID-234E** color azul de 4 kg  
**ID-234F** color verde de 4 kg

*ID-234D* 4 kg red  
*ID-234E* 4 kg blue  
*ID-234F* 4 kg green



## Pastilla RAIDEX para arnés *RAIDEX harness wax blocks*

**ID-290** Rojo                      *ID-290* Red  
**ID-291** Azul                      *ID-291* Blue  
**ID-292** Verde                      *ID-292* Green  
**ID-293** Amarilla                      *ID-293* Yellow

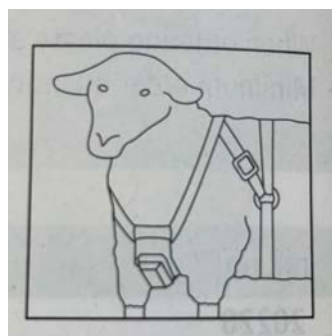
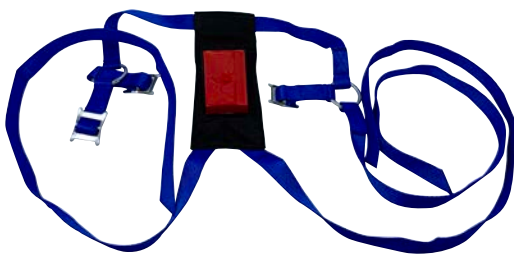

## **ID-295** Arnés de nailon para marcaje en ovino con pastillas RAIDEX

*ID-295* Nylon **harness** for sheep marking  
with RAIDEX wax blocks



**ID-235** Tenaza sacabocados HAUPTNER

**ID-236** Accesorio redondo para tenaza HAUPTNER

**ID-235** Ear notcher HAUPTNER

**ID-236** Round accessory for HAUPTNER ear notcher



**ID-330** Tenaza sacabocados niquelada

**ID-330** Nickel-plated ear notcher



**ID-305**

**ID-302**

**ID-300** Tenaza para aretes Dorital, HAUPTNER

**ID-302** Marcas Dorital, HAUPTNER, metálicas remache redondo, paq. de 100 uds

**ID-304** Tenaza supercrotal, HAUPTNER, grande y ovalada

**ID-305** Aretes supercrotal HAUPTNER, grandes y ovalada, paq de 100 uds

**ID-300** HAUPTNER Dorital ear tags applicator

**ID-302** HAUPTNER Dorital round tip ear tags, box of 100 pcs

**ID-304** HAUPTNER supercrotal ear tags plier

**ID-305** HAUPTNER supercrotal ear tags, box of 100 pcs

# Identificación Identification



**ID-308 Marcas metálicas** numeradas para conejos, paq. de 100 uds  
**ID-309 Marcas metálicas** manuales numeradas para conejos, paq. de 100 uds

*ID-308 Metallic ear tags for rabbits, numbered. box of 100 units*  
*ID-309 Hand metallic ear tags for rabbits, numbered. box of 100 units*

**ID-307 Tenaza** para marcas de conejos  
**ID-307 Applicator** for rabbits ear tags

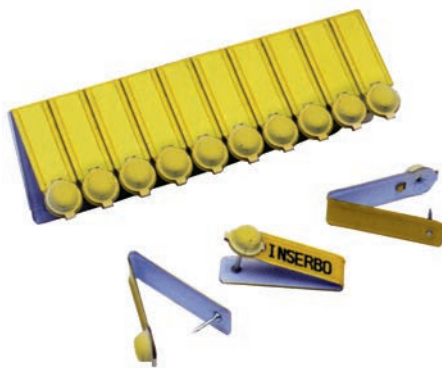
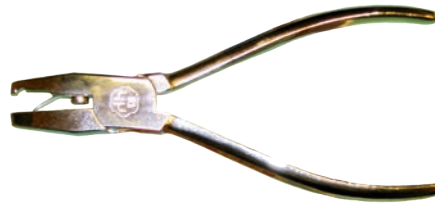

**ID-311 Marcas Durafix HAAPTNER**, paq. de 100 uds

*ID-311 HAAPTNER Durafix ear tags, box of 100 pcs*



**ID-790 Rotulador** para marcas INSEFIX

*ID-790 INSEFIX marker for ear tags*



**ID-660 Tenaza** para marcas INSEFIX mini

*ID-660 Applicator for Insefix small ear tags*



**ID-650 Marcas INSEFIX mini**, sin numerar  
**ID-655 Marcas INSEFIX mini**, numeradas  
**ID-656 Marcas INSEFIX mini**, numeradas, 2 caras

*ID-650 Small INSEFIX ear tags, unnumbered*  
*ID-655 Small INSEFIX ear tags, numbered*  
*ID-656 Small INSEFIX ear tags, numbered, 2 sides*



**Tamaño real**  
**Real size**

**Colores disponibles: amarillo, blanco, azul, verde, rojo, salmón y violeta**  
*Available colors: yellow, white, blue, green, red, salmon and violet*



**Tamaño real**  
*Real size*



**ID-700 Marcas** pala macho pequeña INSERTFIX, sin numerar  
**ID-705 Marcas** pala macho pequeña INSERTFIX, numeradas

*ID-700 INSERTFIX small ear tags, male, shovel form, unnumbered*  
*ID-705 INSERTFIX small ear tags, male, shovel form, numbered*

**ID-710 Marcas** INSERTFIX pala hembra pequeña, sin numerar  
**ID-715 Marcas** INSERTFIX pala hembra pequeña, numeradas

*ID-710 INSERTFIX small ear tags, female, shovel form, unnumbered*  
*ID-715 INSERTFIX small ear tags, female, shovel form, numbered*



**Tamaño real**  
*Real size*



**ID-743 Marcas** pala macho grande INSERTFIX, sin numerar  
**ID-744 Marcas** pala macho grande INSERTFIX, numeradas

*ID-743 INSERTFIX big ear tags, male, shovel form, unnumbered*  
*ID-744 INSERTFIX big ear tags, male, shovel form, numbered*

**ID-745 Marcas** pala hembra grande INSERTFIX, sin numerar  
**ID-750 Marcas** pala hembra grande INSERTFIX, numeradas

*ID-745 INSERTFIX big ear tags, female, shovel form, unnumbered*  
*ID-750 INSERTFIX big ear tags, female, shovel form, numbered*



**Tamaño real**  
*Real size*

**ID-755 Marcas** pala hembra maxi INSERTFIX, sin numerar  
**ID-760 Marcas** pala hembra maxi INSERTFIX, numeradas

*ID-755 INSERTFIX ear tags, female, shovel form, maxi, unnumbered*  
*ID-760 INSERTFIX ear tags, female, shovel form, maxi, numbered*

# Identificación Identification



**ID-775** Tenaza para marcas INSERFIX

*ID-775 INSERFIX applicator for ear tags*



**ID-780** Aguja de recambio para tenaza INSERFIX

*ID-780 Spare **spin** for INSERFIX applicator*



**ID-720** Marcas botón hembra INSERFIX, sin numerar

**ID-721** Marcas botón hembra INSERFIX, numerada

*ID-720 INSERFIX ear tags, female, button form, unnumbered*

*ID-721 INSERFIX ear tags, female, button form, numbered*



**Tamaño real**  
*Real size*



**ID-725** Marcas botón macho con punta de metal INSERFIX, sin numerar

**ID-730** Marcas botón macho con punta de metal INSERFIX, numerada

*ID-725 INSERFIX ear tags, male, button form with metallic point, unnumbered*

*ID-730 INSERFIX ear tags, male, button form with metallic point, numbered*



**Tamaño real**  
*Real size*



**ID-723** Marca botón macho con punta de metal INSERFIX, "cuello largo"

*ID-723 INSERFIX ear tags, male, button form with metallic point, "long neck"*



**ID-735** Marcas botón macho INSERFIX, con punta de plástico sin numerar

**ID-740** Marcas botón macho INSERFIX, con punta de plástico, numerada

*ID-735 INSERFIX ear tags, male, button form with plastic point, unnumbered*

*ID-740 INSERFIX ear tags, male, button form with plastic point, numbered*



**Tamaño real**  
*Real size*



Tamaño real  
Real size



- ID-815 Marcas** pala macho INSEFIX, júnior, sin numerar
- ID-820 Marcas** pala macho INSEFIX, júnior, numeradas
- ID-821 Marcas** pala hembra INSEFIX, júnior, sin numerar
- ID-822 Marcas** pala hembra INSEFIX, júnior, numeradas

- ID-815 INSEFIX ear tags, male, shovel form, junior, unnumbered*
- ID-820 INSEFIX ear tags, male, shovel form, junior, numbered*
- ID-821 INSEFIX ear tags, female, shovel form, junior, unnumbered*
- ID-822 INSEFIX ear tags, female, shovel form, junior, numbered*



Tamaño real  
Real size



- ID-800 Marcas** pala hembra INSEFIX, sénior, sin numerar
- ID-805 Marcas** pala hembra INSEFIX, sénior, numeradas
- ID-810 Marcas** pala hembra INSEFIX, sénior, numeradas, dos caras
- ID-811 Marcas** pala macho INSEFIX, sénior, sin numerar
- ID-812 Marcas** pala macho INSEFIX, sénior, numeradas

- ID-800 INSEFIX ear tags, female, shovel form, senior, unnumbered*
- ID-805 INSEFIX ear tags, female, shovel form, senior, numbered*
- ID-810 INSEFIX ear tags, female, shovel form, senior, numbered, 2 sides*
- ID-811 INSEFIX ear tags, male, shovel form, senior, unnumbered*
- ID-812 INSEFIX ear tags, male, shovel form, senior, numbered*



## Disponemos de crotales electrónicos y lectores

Electronic ear tags and readers available



**ID-829** Marcas INSERTIFX conjunto mini oficial, paq. 10 uds

**ID-829A** Marcas INSERTIFX conjunto mini oficial

“numerado”, paq. 10 uds

**ID-829B** Marcas INSERTIFX conjunto mini oficial “numerado

2 caras”, paq. 10 uds

**ID-829** INSERTIFX mini official eartags, bag of 10 pcs

**ID-829A** INSERTIFX mini official eartags numbered, bag of 10 pcs

**ID-829B** INSERTIFX mini official eartags numbered 2 sides, bag of 10 pcs

## Identificación Identification

### Marcas pala mini INSERTIFX cerrada INSERTIFX closed mini ear tags



**ID-824** Pala hembra mini INSERTIFX paq. 100 uds

**ID-824N** Pala hembra mini INSERTIFX, numeradas paq. 100 uds

**ID-828** Pala macho mini INSERTIFX paq. 100 uds

**ID-828N** Pala macho mini INSERTIFX, paq. 100 uds numerada

**ID-824** INSERTIFX mini female ear tags, shovel form, bag of 100 pcs

**ID-824N** INSERTIFX mini female ear tags, shovel form, bag of 100 pcs, numbered

**ID-828** INSERTIFX mini male ear tags, shovel form, bag of 100 pcs

**ID-828N** INSERTIFX mini male ear tags, shovel form, bag of 100 pcs, numbered

### Tamaño real Real size



**ID-827** Marcas pala hembra INSERTIFX, grande cerrada, sin numerar, paq. 100 uds

**ID-827N** Marcas pala hembra INSERTIFX, grande cerrada, numerada, paq. 100 uds

**ID-827** INSERTIFX big female ear tags, shovel form, closed model, unnumbered, bag of 100 pcs

**ID-827N** INSERTIFX big female ear tags, shovel form, closed model, numbered, bag of 100 pcs



**ID-826** Marcas pala hembra INSERTIFX, mediana cerrada, sin numerar, paq. 100 uds

**ID-826N** Marcas pala hembra INSERTIFX, mediana cerrada, numerada, paq. 100 uds

**ID-826** INSERTIFX medium female ear tags, shovel form, closed model, unnumbered, bag of 100 pcs

**ID-826N** INSERTIFX medium female ear tags, shovel form, closed model, numbered, bag of 100 pcs



**ID-823** Marcas botón hembra cerrada INSERTIFX, sin numerar, paq. 100

**ID-823** INSERTIFX closed button female ear tags, unnumbered, bag of 100 pcs



**ID-825** Marcas pala hembra INSERTIFX, pequeña cerrada, sin numerar, paq. 100 uds

**ID-825N** Marcas pala hembra INSERTIFX, pequeña cerrada, numerada, paq. 100 uds

**ID-825** INSERTIFX small female ear tags, shovel form, closed model, unnumbered, bag of 100 pcs

**ID-825N** INSERTIFX small female ear tags, shovel form, closed model, numbered, bag of 100 pcs



**ID-695 Marcas** para colgar INSERTIFIX  
**ID-696 Marcas** para colgar INSERTIFIX, numeradas

*ID-695 INSERTIFIX neck tags*  
*ID-696 INSERTIFIX neck tags, numbered*

**Tamaño real**  
*Real size*



**ID-790 Rotulador** para marcas INSERTIFIX

*ID-790 INSERTIFIX marker for ear tags*



**ID-795 Rotulador** ALLFLEX Tag-Pen con dos puntas

*ID-795 ALLFLEX Tag-pen marker (2 tips)*



**II-100 Planning** completo para control de granjas

*II-100 Complete planning for farm control*



**II-110 Imanes** cuadrados para planning. Colores: amarillo, azul, rojo y verde, paq. de 100 uds

*II-110 Magnets for planning. Different colours: yellow, blue, red and green, 100 units bag*

**II-130 Imanes** redondos para planning. Colores: amarillo, azul, rojo y verde, paq. de 100 uds

*II-130 Rounded magnets for planning. Different colours: yellow, blue, red and green, 100 units bag*

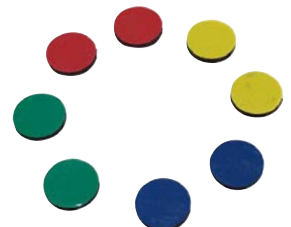





**ID-620** Tenaza ALLFLEX  
**ID-625** Aguja de recambio ALLFLEX

*ID-620 ALLFLEX ear tags applicator*  
*ID-625 ALLFLEX spare spin*



**ID-600** Marcas botón macho ALLFLEX  
**ID-601** Marcas botón macho ALLFLEX, numeradas

*ID-600 ALLFLEX round male ear tags*  
*ID-601 ALLFLEX round male ear tags, numbered*



**ID-602** Marcas botón macho cuello largo ALLFLEX

*ID-602 ALLFLEX round male ear tags, long neck*

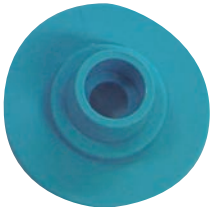

**ID-605** Marcas botón hembra ALLFLEX  
**ID-604** Marcas botón hembra ALLFLEX, numeradas

*ID-605 ALLFLEX round female ear tags*  
*ID-604 ALLFLEX round female ear tags, numbered*



**ID-615** Marcas pala hembra ALLFLEX, mediana, sin numerar  
**ID-616** Marcas pala hembra ALLFLEX, mediana, numeradas

*ID-615 ALLFLEX medium female ear tags, unnumb.*  
*ID-616 ALLFLEX medium female ear tags, numbered*



**ID-610** Marcas ALLFLEX pala macho, mediana, sin numerar  
**ID-611** Marcas ALLFLEX pala macho, mediana, numeradas

*ID-610 ALLFLEX medium male ear tags, unnumb.*  
*ID-611 ALLFLEX medium male ear tags, numbered*

Colores disponibles: amarillo, azul, blanco, rojo y verde.  
Todas las marcas están a tamaño real

*Available colours: Yellow, blue, white, red and green*  
*All ear-tags are actual size*

## Identificación Identification

**ID-630** Marcas pala hembra ALLFLEX, júnior, sin numerar  
**ID-630A** Marcas pala hembra ALLFLEX, júnior, numeradas

*ID-630 ALLFLEX junior female ear tags, unnumb.*  
*ID-630A ALLFLEX junior female ear tags, numbered*



**ID-631** Marcas ALLFLEX pala macho, júnior, sin numerar  
**ID-631A** Marcas ALLFLEX pala macho, júnior numeradas

*ID-631 ALLFLEX junior male ear tags, unnumb.*  
*ID-631A ALLFLEX junior male ear tags, numbered*



**ID-618** Marcas ALLFLEX pala hembra, maxi, sin numerar  
**ID-619** Marcas ALLFLEX pala hembra, maxi, numerada

*ID-618 ALLFLEX maxi female ear tags, unnumb.*  
*ID-619 ALLFLEX maxi female ear tags, numbered*



**ID-636** Marcas ALLFLEX pala macho, pentag  
**ID-637** Marcas ALLFLEX pala hembra, pentag

*ID-636 ALLFLEX male ear tags, pentag*  
*ID-637 ALLFLEX female ear tags, pentag*



**ID-603** Marcas ALLFLEX botón hembra, electrónico FDX

*ID-603 ALLFLEX round female ear tags, FDX electronic*



**ID-634** Marcas ALLFLEX pala hembra, sénior, sin numerar  
**ID-635** Marcas ALLFLEX pala hembra, sénior, numerada

*ID-634 ALLFLEX senior female ear tags, unnumb.*  
*ID-635 ALLFLEX senior female ear tags, numbered*



**ID-632** Marcas ALLFLEX pala macho, sénior, sin numerar  
**ID-633** Marcas ALLFLEX pala macho, sénior, numerada

*ID-632 ALLFLEX senior male ear tags, unnumb.*  
*ID-633 ALLFLEX senior male ear tags, numbered*



**ID-623** Cuchillo cúter cortador de crotales ALLFLEX

*ID-623 ALLFLEX ear tag cutter*



**ID-623A** Cuchillo cúter cortador de crotales

*ID-623A Ear tag cutter*



**ID-785** Tenaza para marcas INSERTIFX con aguja basculante

*ID-785 INSERTIFX applicator for ear tags with tilting needle*



**ID-621** Aplicador ALLFLEX, automático

*ID-621 ALLFLEX automatic applicator*



**ID-795 Rotulador ALLFLEX Tag Pen, doble con dos puntas**

**ID-795** ALLFLEX tag pen **marker** (two tips)



**ID-622 Tenaza para crotales universal**

**ID-622** Universal **applicator** for ear tags



**ID-625A Aguja de recambio para tenaza universal**

**ID-625A** Spare **spin** for universal applicator



**ID-782 Tenaza para marcas "automática" INSERFIX a baterías**

**ID-782** INSERFIX **battery powered eartag plier**



**ID-596 Lector ALLFLEX tipo espada AWR300**

**ID-596** ALLFLEX sword type **reader** AWR300



**ID-597 Lector ALLFLEX tipo espada AWR250**

**ID-597** ALLFLEX sword type **reader** AWR250



**ID-575 Tenaza ALLFLEX aplicadora TST muestras de tejidos**  
**ID-570 Marcas ALLFLEX kit TST para muestras de tejidos BOT+BOT**

**ID-575** ALLFLEX tissue sampling TST tag **applicator**

**ID-570** Ear tags ALLFLEX kit for tissue sampling BOT+BOT



**ID-786 Lector INSERFIX para crotales ISO11784, FDX-B, ID64, HDX**

**ID-786** INSERFIX **reader** for ear tags ISO11784, FDX-B, ID64, HDX

**Precinto de plástico**  
*Plastic seal*

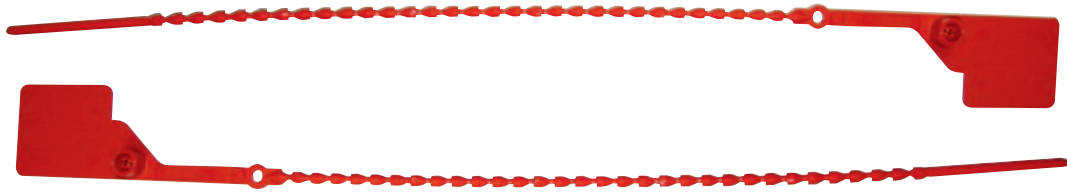

- ID-874** N°4 sin numerar, paq. 1.000 uds
- ID-875** N°4 numerado o solo grabación, paq. 1.000 uds
- ID-876** N°4 solo grabación, paq. 1.000 uds
- ID-877** N°4 numerado y grabado, paq. 1.000 uds

- ID-874** N.4 unnumbered (bag of 1,000 pcs)
- ID-875** N.4 numbered or printed (bag of 1,000 pcs)
- ID-876** N.4 only printed (bag of 1,000 pcs)
- ID-877** N.4 numbered and printed (bag of 1,000 pcs)



**Tamaño real**  
*Real size*

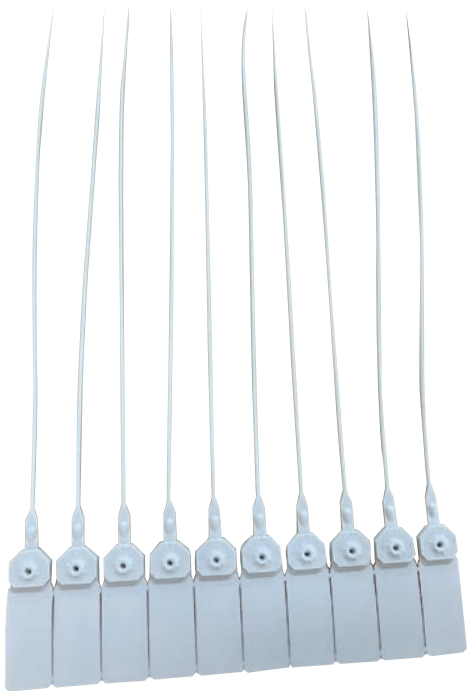

- ID-880** Precinto de plástico sin numerar color blanco
- ID-880** *White unnumbered plastic seal*



- ID-830** Anillas para aves con clip, paq. de 100 (diámetro 8 mm)
- ID-830** *Bird rings with clip, pack of 100 units (diameter 8 mm)*

# Identificación Identification



**Collares de plástico para ovejas**  
*Plastic collars for sheep*

<b>ID-850</b> Azul claro	<b>ID-850</b> Light blue
<b>ID-850A</b> Azul oscuro	<b>ID-850A</b> Dark blue
<b>ID-851</b> Amarillo	<b>ID-851</b> Yellow
<b>ID-852</b> Rojo	<b>ID-852</b> Red
<b>ID-853</b> Verde claro	<b>ID-853</b> Light green
<b>ID-853A</b> Verde oscuro	<b>ID-853A</b> Dark green
<b>ID-854</b> Naranja	<b>ID-854</b> Orange
<b>ID-855</b> Negro	<b>ID-855</b> Black
<b>ID-856</b> Blanco	<b>ID-856</b> White



**Pulseras de plástico para identificación de vacuno**  
*Plastic bracelets for cattle identification*

<b>ID-865</b> Amarillo	<b>ID-865</b> Yellow
<b>ID-866</b> Rojo	<b>ID-866</b> Red
<b>ID-867</b> Azul	<b>ID-867</b> Blue
<b>ID-868</b> Verde	<b>ID-868</b> Green
<b>ID-869</b> Naranja	<b>ID-869</b> Orange



**Cinta nailon con velcro para vacuno, paq. de 10 uds**  
*Nylon tape with velcro for cattle, pack of 10 units*

<b>ID-860</b> Verde	<b>ID-860</b> Green
<b>ID-861</b> Amarillo	<b>ID-861</b> Yellow
<b>ID-862</b> Rojo	<b>ID-862</b> Red
<b>ID-863</b> Azul	<b>ID-863</b> Blue





- IL-300 Bombilla** de infrarrojos cristal duro INERBO, 100 W, roja
- IL-305 Bombilla** de infrarrojos cristal duro INERBO, de 150 W, roja
- IL-310 Bombilla** de infrarrojos cristal duro INERBO, de 175 W, roja

*IL-300 Hard glass INERBO 100 W. infrared **bulb**, red*  
*IL-305 Hard glass INERBO 150 W. infrared **bulb**, red*  
*IL-310 Hard glass INERBO 175 W. infrared **bulb**, red*

- IL-320 Bombilla** de infrarrojos cristal duro INERBO, de 100 W, blanca
- IL-325 Bombilla** de infrarrojos cristal duro INERBO, de 150 W, blanca
- IL-330 Bombilla** de infrarrojos cristal duro INERBO, de 175 W, blanca

*IL-320 Hard glass INERBO 100 W. infrared **bulb**, clear*  
*IL-325 Hard glass INERBO 150 W. infrared **bulb**, clear*  
*IL-330 Hard glass INERBO 175 W. infrared **bulb**, clear*



- IL-245 Bombilla** de infrarrojos INERBO, de 100 W, roja
- IL-250 Bombilla** de infrarrojos INERBO, de 150 W, roja
- IL-255 Bombilla** de infrarrojos INERBO, de 175 W, roja
- IL-260 Bombilla** de infrarrojos INERBO, de 250 W, roja

*IL-245 100 W. INERBO infrared **bulb**, red*  
*IL-250 150 W. INERBO infrared **bulb**, red*  
*IL-255 175 W. INERBO infrared **bulb**, red*  
*IL-260 250 W. INERBO infrared **bulb**, red*

- IL-265 Bombilla** de infrarrojos INERBO, de 150 W, blanca
- IL-270 Bombilla** de infrarrojos INERBO, de 175 W, blanca
- IL-275 Bombilla** de infrarrojos INERBO, de 250 W, blanca

*IL-265 150 W. INERBO infrared **bulb**, clear*  
*IL-270 175 W. INERBO infrared **bulb**, clear*  
*IL-275 250 W. INERBO infrared **bulb**, clear*



## Bombilla de infrarrojos PHILIPS PHILIPS Infrared bulb



**IL-130** De 150 W, roja  
**IL-135** De 250 W, roja

**IL-130** 150 W. red  
**IL-135** 250 W. red



**IL-138** De 100 W, roja, cristal duro  
**IL-140** De 175 W, roja, cristal duro

**IL-138** 100 W. red, hard glass  
**IL-140** 175 W. red, hard glass



**IL-141** De 175 W, blanca, cristal duro

**IL-141** 175 W. clear, hard glass

**Lámpara** protectora de bombilla infrarrojos, con cadena y economizador  
*Infrared lamp holder; supplied with chain and economiser*



**IL-125** Cable de 2,5 m  
**IL-126** Cable de 5 m  
**IL-101** Cable de 2,5 m, caja de 10 uds. (sin montar)  
**IL-103** Cable de 5 m, caja de 10 uds. (sin montar)

**IL-125** 2.5 m cord  
**IL-126** 5 m cord  
**IL-101** 2.5 m cord, box of 10 units (unmounted)  
**IL-103** 5 m cord, box of 10 units (unmounted)

**Lámpara** protectora de bombilla de infrarrojos con cadena  
*Infrared lamp holder; supplied with chain*



**IL-120** Cable de 2,5 m  
**IL-121** Cable de 5 m  
**IL-100** Cable de 2,5 m, caja de 10 uds. (sin montar)  
**IL-102** Cable de 5 m, caja de 10 uds. (sin montar)

**IL-120** 2.5 m cord  
**IL-121** 5 m cord  
**IL-100** 2.5 m cord, box of 10 units (unmounted)  
**IL-102** 5 m cord, box of 10 units (unmounted)

**Bombilla** de infrarrojos INTERHEAT roja  
*Red INTERHEAT infrared bulb*



**IL-195** De 100 W  
**IL-200** De 150 W  
**IL-205** De 175 W  
**IL-210** De 250 W

**IL-195** 100 W  
**IL-200** 150 W  
**IL-205** 175 W  
**IL-210** 250 W

**Bombilla** de infrarrojos INTERHEAT blanca  
*Clear INTERHEAT infrared bulb*



**IL-215** De 150 W  
**IL-220** De 175 W  
**IL-225** De 250 W

**IL-215** 150 W  
**IL-220** 175 W  
**IL-225** 250 W



**IL-115** Portalámparas para bombillas infrarrojas con cable de 3 m  
**IL-117** Portalámparas para bombillas infrarrojas con cable de 2,5 m y economizador

**IL-115** Infrared bulbs lamp holder with 3 m cable  
**IL-117** Infrared bulbs lamp holder with 2.5 m cable and economizer



## NUEVO SISTEMA DE CALEFACCIÓN CON REFLECTORES Y BOMBILLAS DE CUARZO

*New heating system with reflectors and quartz bulbs*



**IL-175 Reflector** de cuarzo rojo de 250 W  
**IL-180 Reflector** de cuarzo rojo de 175 W

*IL-175 Quartz reflector, red, 250 W.*  
*IL-180 Quartz reflector, red, 175 W.*

Excepcionales, de alta calidad.  
 Muy fuertes y robustos.  
 Resistentes a choques.  
 De larga duración: tienen una duración de 10.000 horas, nunca experimentada antes.  
 Resistentes a salpicaduras de agua.

*Exceptional high quality.*  
*Very strong and robust.*  
*Crash resistant.*  
*Long life: about 10,000 hours, never experienced before.*

No se funde al salpicar con un spray de agua o de desinfectante, cuando la bombilla está en funcionamiento.

*It doesn't fuse when splashed with water spray or disinfectant while the bulb is on.*



## REFLECTORES DE CUARZO

*Quartz reflectors*

**IL-185 Reflector** de cuarzo blanco de 250 W  
**IL-190 Reflector** de cuarzo blanco de 175 W

*IL-185 Quartz reflector, clear, 250 W.*  
*IL-190 Quartz reflector, clear, 175 W.*



SE ADAPTAN A LOS PORTALÁMPARAS TRADICIONALES  
 Ref. **IL-120, IL-121, IL-125 y IL-126**

*To adapt on traditional lamp holders*  
 Ref. **IL-120, IL-121, IL-125 and IL-126**



# Reflectores Reflectors

- Se utiliza con las bombillas de cuarzo.
- Ideal para porcino, avicultura, cunicultura, etc.
- Tiene un interruptor para economizar energía de tres posiciones: parado, 50% de potencia y 100% de potencia, según se desee dar más o menos calor o ahorrar en consumo eléctrico.
- Muy fuertes y robustas, resistentes a choques.
- No se funden al salpicar con agua, cuando está en funcionamiento.
- Larga duración: pruebas de laboratorio certifican una duración de vida de 10.000 horas.
- Se suministra con cable de 2,5 metros y rejilla protectora.
- Fabricada en aluminio y acero Inox.
- Cumple las normas de la CE.

- Used with quartz bulbs.
- Suitable for pig, poultry, rabbit breeding etc...
- Three positions economiser switch: off, 50% power, 100% power, depending on how much heat you want or if you wish to save electricity.
- Very strong and robust. Crash resistant.
- They don't fuse when splashed with water while the bulb is on.
- Long life: laboratory tests certify 10,000 hours of life.
- Supplied with a 2.5 m. cable and a protecting grille.
- Made of aluminium and stainless steel.
- They follow the CE rules.

## PORTALÁMPARAS CON ECONOMIZADOR PARA BOMBILLAS DE CUARZO *Quartz bulb economiser lamp-holder*



**IL-150** Portalámparas con economizador para bombillas de cuarzo

**IL-150** Lamp holder for quartz bulbs with economiser

### ALTO EFECTO BIOLÓGICO

Por otra parte, la calefacción con bombilla de cuarzo permite un mejor reparto del calor en todo el cuerpo del animal, mejorando la circulación sanguínea y aumentando el confort del animal.

#### *High biological effect:*

*quartz bulb allows a better spreading of heat on the animal body: improving blood circulation and comfort.*



**Bombilla** de cuarzo  
*Quartz bulb*

**IL-155** Roja de 250 W

**IL-160** Roja de 175 W

**IL-165** Blanca de 175 W

**IL-170** Blanca de 250 W

**IL-155** Red, 250 W.

**IL-160** Red, 175 W.

**IL-165** Clear, 175 W.

**IL-170** Clear, 250 W.

## BOMBILLA DE CUARZO *Quartz bulb*



**Bombilla** de cuarzo roja INSERBO  
*INSERBO red quartz bulb*

**IL-155A** De 250 W

**IL-160A** De 175 W

**IL-155A** 250 W.

**IL-160A** 175 W.



**IN-120** Lazo para coger cerdos

*IN-120 Pig holder*

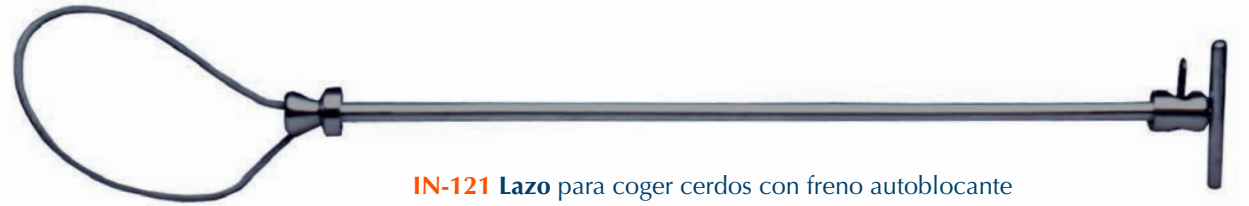

**IN-121** Lazo para coger cerdos con freno autoblocante

*IN-121 Pig holder with self locking device*

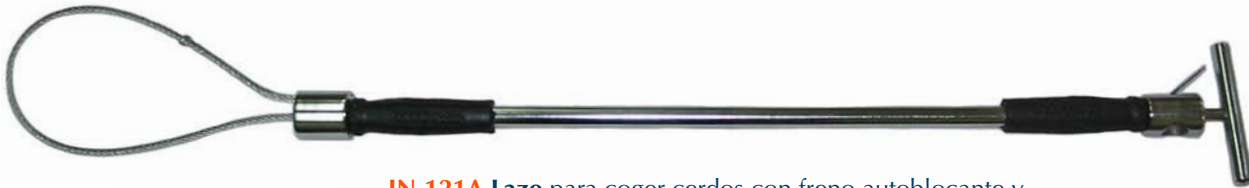

**IN-121A** Lazo para coger cerdos con freno autoblocante y mandos antideslizamiento

*IN-121A Pig holder with self locking device and anti slippery handle*



**IN-121B** Lazo para coger cerdos "extra grueso"

*IN-121B "Extra thick" pig holder*

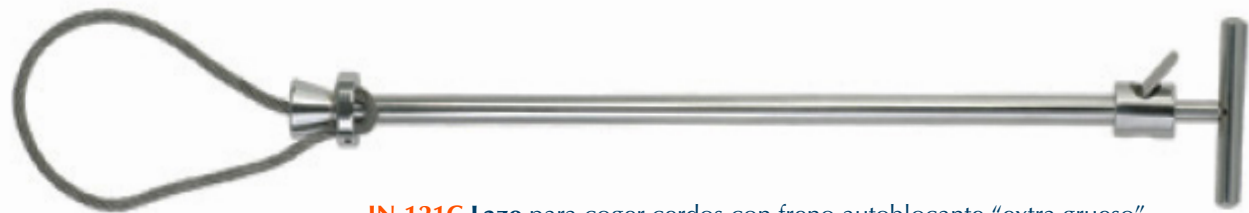

**IN-121C** Lazo para coger cerdos con freno autoblocante "extra grueso"

*IN-121C Pig holder with self locking device "extra thick"*



**IN-121X** Lazo para coger cerdos con mango corto

*IN-121X Pig holder with short handle*

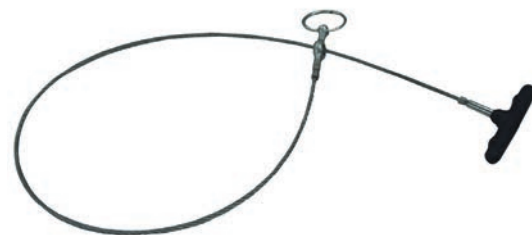

**IN-122** Lazo para coger cerdos sin tubo

*IN-122 Pig holder without tube*

## Lazos / Empujadores / Tableros Pig holders / Coaxers / Sorting panels



**IN-147BA** Pala arreadora sonajera flexible

*IN-147BA Flexible rattle paddle*



**IN-147C** Pala arreadora "corta" para empujar ganado

*IN-147C "Short" paddle for livestock handling*



**Tablero** para arrear ganado **INSERBO**  
*INSERBO sorting board for livestock handling*

**IN-147A** 76 x 96 cm

**IN-147D** 76 x 49 cm

**IN-147F** 76 x 120 cm



**IN-147** Pala arreadora sonajera para empujar el ganado

*IN-147 Rattle paddle for livestock handling*



**IN-136A** Empujador KAWE 21 (por impulsos)

*IN-136A KAWE 21 impulse coaxer*



**IN-130** Empujador eléctrico HAUPTNER

*IN-130 HAUPTNER electrical coaxer*



**IN-135** Empujador eléctrico TORERO

*IN-135 TORERO electrical coaxer*

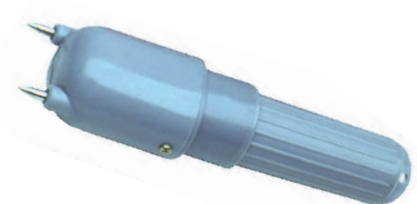

**IN-136** Empujador eléctrico KAWE

*IN-136 KAWE electrical coaxer*



**IN-137** Alargo para empujador KAWE

*IN-137 KAWE shaft*

**IN-166** Empujador MAGIC SHOCK azul con alargo de 55 cm

*IN-166 MAGIC SHOCK blue coaxer with 55 cm shaft*

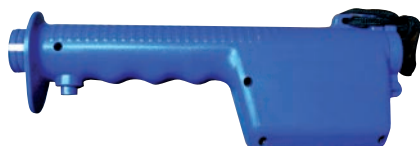

**Alargos flexibles**  
*Flexible shaft*

**IN-175** 30 cm

**IN-176** 55 cm

**IN-177** 65 cm

**IN-178** 80 cm

**IN-179** 106 cm

**IN-165** Empujador MAGIC SHOCK azul sin alargo

*IN-165 MAGIC SHOCK blue coaxer without shaft*

**IN-186** Empujador eléctrico recargable STARVET-SHOCK con alargo de 58 cm

**IN-187** Empujador eléctrico recargable STARVET-SHOCK con alargo de 84 cm

*IN-186 STARVET-SHOCK rechargeable coaxer with 58 cm shaft*

*IN-187 STARVET-SHOCK rechargeable coaxer with 84 cm shaft*

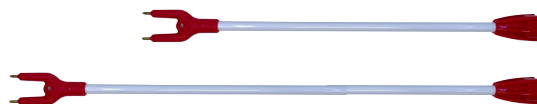

**Alargos STARVET-SHOCK**  
*STARVET-SHOCK shaft*

**IN-190** 33 cm

*IN-190 33 cm*

**IN-191** 58 cm

*IN-191 58 cm*

**IN-192** 71 cm

*IN-192 71 cm*

**IN-193** 84 cm

*IN-193 84 cm*

**IN-194** 109 cm

*IN-194 109 cm*

**IN-185** Empujador eléctrico recargable STARVET-SHOCK

*IN-185 STARVET-SHOCK rechargeable coaxer*



**IN-196** Baterías recambio empujador STARVET-SHOCK

**IN-197** Cargador coche para empujador STARVET-SHOCK

*IN-196 STARVET-SHOCK spare battery*

*IN-197 Car charger for STARVET-SHOCK coaxer*



**IN-180** Empujador MAGIC SHOCK corto

*IN-180 MAGIC SHOCK short coaxer*



**IN-181** Funda de piel para empujador IN-180

*IN-181 Leather cover for IN-180 coaxer*



**IN-144BA** Paq. de 2 pilas alcalinas LR14 de 1,5 V

*IN-144BA 2 alkaline LR14 1.5 V batteries pack*





**IP-161** Protector de hombros

*IP-161 Shoulder protection*



**IP-150** Bata para partos de 130 cm de largo

**IP-151** Bata para partos de 140 cm de largo

*IP-150 Obstetric coat, 130 cm long*

*IP-151 Obstetric coat, 140 cm long*



**Mono para partos**  
*Obstetric overall*

- IP-145** Pequeña    *IP-145 Small*
- IP-146** Mediana    *IP-146 Medium*
- IP-147** Grande    *IP-147 Large*



**Chaqueta para partos**  
*Obstetric jacket*

- IP-160** Talla pequeña
- IP-160A** Talla mediana
- IP-160B** Talla grande

*IP-160 Small size*  
*IP-160A Medium size*  
*IP-160B Large size*

**Pantalón para partos**  
*Obstetric trousers*

- IP-155** Talla pequeña
- IP-156** Talla mediana
- IP-157** Talla grande

*IP-155 Small size*  
*IP-156 Medium size*  
*IP-157 Large size*



**IP-162** Delantal para partos de 120 cm de largo (verde)

*IP-162 Obstetric long apron, 120 cm (green)*



**Mono desechable** con capucha, azul  
*Blue disposable overall with hood*

**IP-124A** Talla L / Size L

**IP-125A** Talla XL / Size XL

**IP-126B** Talla XXL / Size XXL

**IP-125C** Talla XXXL / Size XXXL

**IP-126C** Mono desechable con capucha,  
verde, talla XXL

**IP-126C** Green *disposable overall with hood,*  
size XXL



**Mono desechable** con capucha, blanco  
*White disposable overall with hood*

**IP-124** Talla L / Size L

**IP-125** Talla XL / Size XL

**IP-126A** Talla XXL / Size XXL

**IP-126** Talla XXXL / Size XXXL

**IP-127** Mono desechable plastificado  
con capucha, blanco, talla XL

**IP-127** White *plasticized overall with hood,*  
size XL

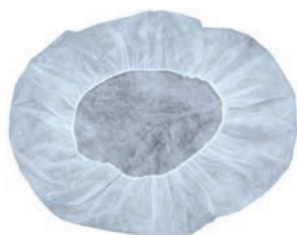

**IP-104** Gorro desechable, paq. de 100 uds

**IP-104A** Gorro desechable azul, paq. de 100 uds

**IP-104** Disposable *cap, bag with 100 pcs*

**IP-104A** Blue disposable *cap, bag with 100 pcs*



**IP-122** Mono desechable plastificado sin capucha, talla XL

**IP-122A** Mono desechable plastificado sin capucha, verde, talla XL

**IP-123** Mono desechable sin capucha, blanco, talla XL

**IP-123A** Mono desechable sin capucha, azul, talla XL

**IP-122** *Plasticized overall without hood, size XL*

**IP-122A** *Plasticized overall without hood, green, size XL*

**IP-123** *White disposable overall without hood, size XL*

**IP-123A** *Blue disposable overall without hood, size XL*



**IP-099 Bata de plástico** cerrada transparente, desechable, paq. de 20 uds

**IP-099** Disposable closed **plastic coat**, transparent. Bag with 20 pcs



**IP-100 Bata de plástico** desechable cerrada, verde, paq. de 20 uds.

**IP-103 Bata** desechable verde cerrada "plegada individual", paq. de 20 uds

**IP-100** Disposable green closed **plastic coat**, bag with 20 pcs

**IP-103** Individually folded green closed **coat**, bag with 20 pcs



**IP-120 Bata de tela** desechable, con bolsillo para visitas en granja

**IP-120** Disposable **cloth coat** with pocket for visits



**Delantal de plástico desechable**  
**Disposable plastic apron**

**IP-108** Blanco, paq. de 100

**IP-108A** Azul, paq. de 100

**IP-108** White, pack of 100

**IP-108A** Blue, pack of 100



**IP-103C Bata de plástico** desechable con capucha. paq. 100

**IP-103C** Disposable plastic **gown** with hood, pack of 100



**IP-119H Mascarilla** quirúrgica (tipo IIR) paq. 50 uds

**IP-119HA Mascarilla** quirúrgica (tipo I) paq. 50 uds, uso no médico

**IP-119H** Surgical **mask** (type IIR) 50 units

**IP-119HA** Surgical **mask** (type I) 50 units, non-medical use



**IP-119 Mascarilla** desechable, con refuerzo, paq. de 50 uds

**IP-119** Disposable surgical **mask** with additional reinforcement, bag with 50 pcs



**IP-119CC Mascarilla** plegable JSP FFP2 con válvula, paq. de 10 uds

**IP-119CC** JSP FFP2 folding **mask** with valve, pack. of 10 pcs



**IP-119DA Mascarilla** FFP2 color negro, paq. de 1 ud

**IP-119DA** Black FFP2 **mask**, bag with 1 pc

**IP-119D Mascarilla** FFP2 color blanco, paq. de 1 ud

**IP-119D** White FFP2 **mask**, bag with 1 pc





**IP-110** Botas altas sujetables verdes, paq. de 100 uds

**IP-110** Green **overboots** with laces, bag with 100 pcs



**IP-111** Botas altas desechables, con goma para sujetar, paq. de 50 uds

**IP-111** Disposable **overboots** (with elastic band) bag with 50 pcs

**Mono desechable con capucha "GRUESO" protección química**  
*Disposable overall with hood "THICK" chemical protection*

**IP-129C** Talla - Size M  
**IP-129D** Talla - Size L  
**IP-129E** Talla - Size XL  
**IP-130** Talla - Size XXL

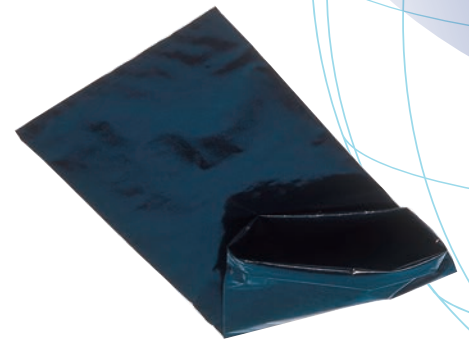

**IP-112** Bolsas para pies negras, paq. de 875 uds

**IP-112** Black plastic **bags for shoes**, bag with 875 units



**Cubrepies con goma para sujetar**  
*Overshoes with elastic band*

**IP-115** Paq. de 100 uds  
**IP-115B** Paq. de 100 uds, gruesos-gofrado

**IP-115** 100 units package  
**IP-115B** Thick, embossed, 100 units package



**IP-102** Pantalón desechable plegado individual, paq. de 20 uds

**IP-102** Disposable **trousers**. individually folded, bag with 20 units



**IP-116** Cubrepies blanco PP de 30gr con goma, paq. de 100 unids

**IP-116** 30g white PP **overshoes** with elastic band, pack of 100 units



**IP-116A** Cubrepies PP azul antideslizante de 30gr con goma, paq. de 100 unids

**IP-116A** 30g blue non-slip PP **overshoes** with elastic band, pack of 100 units



**IP-547 Mascarilla** 3M FFP1 con válvula, paq. 10 uds

*IP-547 3M FFP1 mask with valve, bag with 10 units*



**IP-550 Mascarilla** 3M FFP2 con válvula, paq. 10 uds

*IP-550 3M FFP2 mask with valve, bag with 10 units*



**IP-545 Mascarilla** 3M FFP1 plegable con válvula, paq. 10 uds

*IP-545 3M FFP1 foldable mask with valve, bag with 10 units*



**IP-555 Mascarilla** 3M para gases y vapores

**IP-557 Mascarilla** 3M para gases y vapores, especial amoníaco

*IP-555 3M mask for gases and vapors*

*IP-557 3M mask for gases and vapors, especially ammonia*



**IP-568 Gafas de protección** 3M ergonómica solar

*IP-568 3M ergonomic solar safety glasses*



**IP-570 Gafas de protección** 3M antiempañamiento

*IP-570 3M anti-fog safety glasses*



**IP-565 Gafas de protección** 3M visita, cubregafas

*IP-565 3M visit safety glasses, goggles*



**IP-567 Gafas de protección** 3M ergonómica incolora

*IP-567 Colorless ergonomic 3M safety glasses*



**IP-571 Clip portalentes** 3M para gafas graduadas

*IP-571 3M lens holder clip for prescription glasses*



**IP-579** Cascos para protección auditiva 3M, Peltor Optime

*IP-579 3M Peltor Optime hearing protection helmets*



**IP-585** Cascos para protección oídos 3M, con audición de voz Protac III

*IP-585 3M hearing protection helmets, with Protac III voice hearing*



**IP-575** Tapones para oídos 3M con cordón ultrafit

*IP-575 3M Ultrafit corded ear plugs*



**IP-577** Tapones para oídos 3M con banda

*IP-577 3M banded ear plugs*

## Camisetas ESPABITE ESPABITE Tshirts



**IP-850** hasta **IP-854** Blanca, tallas S hasta XXL

*IP-850 White, size S to XXL*



**IP-856** hasta **IP-860** Verde, tallas S hasta XXL

*IP-856 Green, size S to XXL*



**IP-862** hasta **IP-867** Azul, tallas S hasta XXXL

*IP-862 Blue, size S to XXL*

## Guantes de trabajo de precisión nylon recubrimiento nitrilo Precision work gloves nylon coating nitrile

- |                               |                              |
|-------------------------------|------------------------------|
| <b>IP-535B</b> Talla 7 (S)    | <b>IP-535B</b> Size 7 (S)    |
| <b>IP-535C</b> Talla 8 (M)    | <b>IP-535C</b> Size 8 (M)    |
| <b>IP-535D</b> Talla 9 (L)    | <b>IP-535D</b> Size 9 (L)    |
| <b>IP-535E</b> Talla 10 (XL)  | <b>IP-535E</b> Size 10 (XL)  |
| <b>IP-535F</b> Talla 11 (XXL) | <b>IP-535F</b> Size 11 (XXL) |



## Guantes de látex, paquete de 100 unds STARVET latex gloves, 100 units box



- |                        |                       |
|------------------------|-----------------------|
| <b>Con polvo</b>       | <b>With powder</b>    |
| <b>IP-295</b> Talla XL | <b>IP-295</b> Size XL |
| <b>IP-300</b> Talla L  | <b>IP-300</b> Size L  |
| <b>IP-305</b> Talla M  | <b>IP-305</b> Size M  |
| <b>IP-310</b> Talla S  | <b>IP-310</b> Size S  |



- |                       |                      |
|-----------------------|----------------------|
| <b>Sin polvo</b>      | <b>Powder free</b>   |
| <b>IP-375</b> Talla L | <b>IP-375</b> Size L |
| <b>IP-380</b> Talla M | <b>IP-380</b> Size M |
| <b>IP-385</b> Talla S | <b>IP-385</b> Size S |

## Guantes de vinilo, paquete 100 unds STARVET vinyl gloves, 100 units box



- |                        |                       |
|------------------------|-----------------------|
| <b>Sin polvo</b>       | <b>Powder free</b>    |
| <b>IP-420</b> Talla XL | <b>IP-420</b> Size XL |
| <b>IP-425</b> Talla L  | <b>IP-425</b> Size L  |
| <b>IP-430</b> Talla M  | <b>IP-430</b> Size M  |
| <b>IP-435</b> Talla S  | <b>IP-435</b> Size S  |

- |                       |
|-----------------------|
| <b>Con polvo</b>      |
| <b>IP-400</b> Talla L |
| <b>IP-405</b> Talla M |
| <b>IP-410</b> Talla S |
| <b>With powder</b>    |
| <b>IP-400</b> Size L  |
| <b>IP-405</b> Size M  |
| <b>IP-410</b> Size S  |



**DS-415** Dosificador de jabón y gel automático por infrarrojos

**DS-415** Automatic infrared soap and gel dispenser

**IP-135A** Guantes desechables de plástico, ancho especial, paquete 100 unds

**IP-135A** Disposable plastic gloves, special width, 100 units bag



**DS-410** Gel solución hidoalcohólica SERBONET, 5 l

**DS-410** SERBONET hydroalcoholic solution gel, 5 l



**DS-420** Dosificador de jabón manual

**DS-420** Manual soap dispenser



**IP-140** Manguitos de poliéster de 40 cm (el par)

**IP-140** Oversleeves polyester 40 cm (in pairs)

# Guantes / Higiene Gloves / Hygiene



**Guantes de nitrilo negros (3.5gr) sin polvo, paq. 100 unds.**

*Black nitrile gloves (3.5gr) Powder free, 100 units box*

- |                        |                       |
|------------------------|-----------------------|
| <b>IP-490</b> Talla XL | <b>IP-490</b> Size XL |
| <b>IP-491</b> Talla L  | <b>IP-491</b> Size L  |
| <b>IP-492</b> Talla M  | <b>IP-492</b> Size M  |
| <b>IP-493</b> Talla S  | <b>IP-493</b> Size S  |



**Guantes de nitrilo (3.5gr) sin polvo, paquete de 100 unds**

*Powder free nitrile gloves (3.5gr) 100 units box*

- |                        |                       |
|------------------------|-----------------------|
| <b>IP-445</b> Talla XL | <b>IP-445</b> Size XL |
| <b>IP-450</b> Talla L  | <b>IP-450</b> Size L  |
| <b>IP-455</b> Talla M  | <b>IP-455</b> Size M  |
| <b>IP-460</b> Talla S  | <b>IP-460</b> Size S  |
| <b>IP-465</b> Talla XS | <b>IP-465</b> Size XS |



**Guantes de nitrilo extrafuertes (6gr) sin polvo, paquete 100 unds.**

*Extra strong nitrile gloves (6gr) powder free 100 units box*

- |                        |                       |
|------------------------|-----------------------|
| <b>IP-486</b> Talla XL | <b>IP-486</b> Size XL |
| <b>IP-487</b> Talla L  | <b>IP-487</b> Size L  |
| <b>IP-488</b> Talla M  | <b>IP-488</b> Size M  |
| <b>IP-489</b> Talla S  | <b>IP-489</b> Size S  |



**Guantes de nitrilo profesional (4.6gr) sin polvo, paquete 100 unds**

*Professional nitrile gloves (4.6gr) powder free, 100 units box*

- |                        |                       |
|------------------------|-----------------------|
| <b>IP-470</b> Talla XL | <b>IP-470</b> Size XL |
| <b>IP-475</b> Talla L  | <b>IP-475</b> Size L  |
| <b>IP-480</b> Talla M  | <b>IP-480</b> Size M  |
| <b>IP-485</b> Talla S  | <b>IP-485</b> Size S  |



**Guantes de nitrilo largos (8,8gr) sin polvo, paquete 100 unds**

*Long nitrile gloves (8,8gr) powder free, 100 units box*

- |                        |                       |
|------------------------|-----------------------|
| <b>IP-495</b> Talla XL | <b>IP-495</b> Size XL |
| <b>IP-496</b> Talla L  | <b>IP-496</b> Size L  |
| <b>IP-497</b> Talla M  | <b>IP-497</b> Size M  |
| <b>IP-498</b> Talla S  | <b>IP-498</b> Size S  |



**Guantes de nitrilo ULTRAGRIP naranja (8,5gr), paquete 50 unds**

*Orange ULTRAGRIP nitrile gloves (8,5) 50 units box*

- |                         |                        |
|-------------------------|------------------------|
| <b>IP-530</b> Talla L   | <b>IP-530</b> Size L   |
| <b>IP-531</b> Talla XL  | <b>IP-531</b> Size XL  |
| <b>IP-532</b> Talla XXL | <b>IP-532</b> Size XXL |

**Guantes PVC triple capa con manguito termosellado**  
Triple layer PVC gloves with heat-sealed cuff



**IP-225** Talla 10 (XL)  
**IP-226** Talla 9 (L)  
**IP-227** Talla 8 (M)

**IP-225** Size 10 (XL)  
**IP-226** Size 9 (L)  
**IP-227** Size 8 (M)



**IP-210** Guantes con goma elástica de 55 cm, bolsa de 100 unidades

**IP-210** 55 cm gloves with elastic band, 100 units bag

**Guantes sensitivos naranja de 90 cm**  
90 cm orange sensitive gloves

**IP-200** Bolsa 100 uni.  
**IP-205** Caja 100 uni.

**IP-200** 100 units bag  
**IP-205** 100 units box



**IP-180** Guantes sensitivos de 90 cm, paquete de 100 unidades

**IP-180** Sensitive gloves (90 cm) 100 units box

**IP-175** Guantes supersensitivos de 90 cm, paquete de 100 unidades

**IP-175** Supersensitive gloves (90 cm) 100 units box





**IP-170** Guantes supersensitivos elásticos de 85 cm, paquete de 50 unidades

*IP-170 Elastic supersensitive gloves, 85 cm, 50 units bagox*



**IP-165** Guantes sensitivos de 90 cm GLOVET, paquete de 100 unidades

*IP-165 GLOVET sensitive gloves (90cm), 100 units box*



**IP-195** Guantes sensitivos de 90 cm con lazo para el cuello, paquete de 100 unidades

*IP-195 Sensitive gloves (90 cm) with neck lace, 100 units box*



**IP-190** Guantes de protección de hombro y axila NECK, paquete de 50 unidades

*IP-190 NECK gloves for shoulder and armpit protection, 50 units box*



**Guantes supersensitivos de protección de hombro y axila**

**IP-192** Paq. 100 unds

*Super sensitive gloves for shoulder and armpit protection*

*IP-192 100 units box*



**IP-215** Guantes obstétricos porcino, 90 cm, bolsa de 5 unidades

*IP-215 Pig obstetric gloves, 90 cm, 5 units bag*





**Mono impermeable** para lavado y limpieza

*Washing and cleaning overall*

- IP-810** L
- IP-815** XL
- IP-820** XXL
- IP-825** XXXL



**Conjunto impermeable** pantalón y chaqueta

*Waterproof jacket and trouser set*

- IP-798** S
- IP-799** M
- IP-800** L
- IP-801** XL
- IP-802** XXL
- IP-803** XXXL

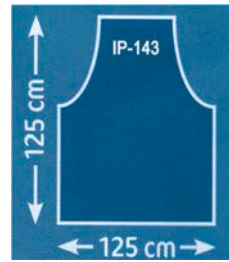
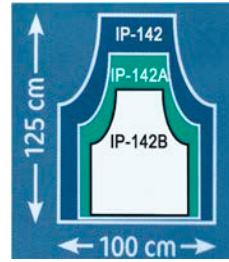
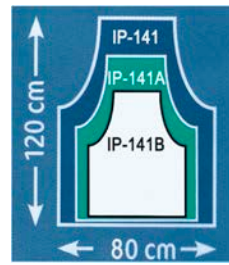

**Delantal** de ordeño y limpieza

*Milking and washing apron*

- |                               |                               |
|-------------------------------|-------------------------------|
| 80 x 120 cm                   | 100 x 125 cm                  |
| <b>IP-141</b> (Azul-Blue)     | <b>IP-142</b> (Azul-Blue)     |
| <b>IP-141A</b> (Verde-Green)  | <b>IP-142A</b> (Verde-Green)  |
| <b>IP-141B</b> (Blanco-White) | <b>IP-142B</b> (Blanco-White) |
| 125 x 125 cm                  |                               |
| <b>IP-143</b> (Azul-Blue)     |                               |



**IP-600** hasta **IP-650** Botas superligeras -30 °C, tallas nº 39 hasta nº 49  
**IP-660** Calcetín para botas superligeras (par)

*IP-600 to IP-650 Light boots -30°, size nº 39 to 49  
 IP-660 Sock for light boots (pair)*



**IP-700** hasta **IP-740** Botas de seguridad superligeras S4 -30 °C, tallas nº 39 hasta nº 47  
**IP-750** Calcetín para botas de seguridad superligeras (par)

*IP-700 to IP-740 Super light safety S4 boots -30°C, size nº 39 to 47  
 IP-750 Socks for safety super light boots (pair)*

## Delantales / Botas Aprons / Boots



**IP-900 hasta IP-912 Botas** BEKINA AGRILITE 04 -20 °C, tallas nº 36 hasta nº 48

**IP-915 hasta IP-927 Botas** BEKINA AGRILITE S4 protección puntera -20 °C, tallas nº 36 hasta nº 48

**IP-930 hasta IP-942 Botas** BEKINA AGRILITE S5 protección completa -20 °C, tallas nº 36 hasta nº 48

**IP-900 to IP-912** BEKINA AGRILITE 04 **boots** -20 °C, sizes nº 36 to nº 48

**IP-915 to IP-927** BEKINA AGRILITE S4 **boots** -20 °C, protective toe cap, sizes nº 36 to nº 48

**IP-930 to IP-942** BEKINA AGRILITE S5 **boots** -20 °C, protective toe and sole, sizes 36 to 48

**IP-945 hasta IP-957 Botas** BEKINA STEPLITE X 04 -30 °C, tallas nº 36 hasta nº 48

**IP-960 hasta IP-972 Botas** BEKINA STEPLITE X S4 protección puntera -30 °C, tallas nº 36 hasta nº 48

**IP-975 hasta IP-987 Botas** BEKINA STEPLITE X S5 protección completa -30 °C, tallas nº 36 hasta nº 48

**IP-945 to IP-957** BEKINA STEPLITE X 04 **boots** -30 °C, sizes nº 36 to nº 48

**IP-960 to IP-972** BEKINA STEPLITE X S4 **boots** -30 °C, protective toe cap, sizes nº 36 to nº 48

**IP-975 to IP-987** BEKINA STEPLITE X S5 **boots** -30 °C, protective toe and sole, sizes nº 36 to nº 48



**Para industria alimentaria**

**IP-990 hasta IP-990L Botas** BEKINA STEPLITE FOOD S4 protección puntera -20 °C, tallas nº 36 hasta nº 48

**IP-990 to IP-990L** BEKINA STEPLITE FOOD S4 **boots** -20 °C, protective toe cap, sizes nº 36 to nº 48



**IP-991A hasta IP-991M Plantillas** BEKINA standard, tallas nº 36 hasta nº 48

**IP-991A to IP-991M** BEKINA standard **insole**, sizes nº 36 to nº 48



**IP-992A hasta IP-992M Plantillas** BEKINA ergonómica y antichoque, tallas nº 36 hasta nº 48

**IP-992A to IP-992M** BEKINA ergonomic and impact protection **insole**, sizes nº 36 to nº 48



**IP-994 hasta IP-994K Botas DUNLOP PUROFORT PROFESSIONAL 04** -20 °C, tallas nº 37 hasta nº 48  
**IP-994 to IP-994K DUNLOP PUROFORT PROFESSIONAL 04 boots** -20 °C, sizes nº 37 to nº 48

**IP-995 hasta IP-995K Botas DUNLOP PUROFORT PROFESSIONAL S5** protección total, tallas nº 37 hasta nº 48  
**IP-995 to IP-995K DUNLOP PUROFORT PROFESSIONAL S5 boots,** protective toe and sole, sizes nº 37 to nº 48

**IP-996 hasta IP-996M Botas DUNLOP PUROFORT PLUS 04** -20 °C, tallas nº 36 hasta nº 50  
**IP-996 to IP-996M DUNLOP PUROFORT PLUS 04 boots** -20 °C, sizes nº 36 to nº 50

**IP-997 hasta IP-997M Botas DUNLOP PUROFORT PLUS S5** protección total -20 °C, tallas nº 36 hasta nº 50  
**IP-997 to IP-997M DUNLOP PUROFORT PLUS S5 boots** -20 °C, protective toe and sole, sizes nº 36 to nº 50



**IP-998 hasta IP-998H Botas DUNLOP PUROFORT THERMO S5** -50 °C, tallas nº 37 hasta nº 48

**IP-998 to IP-998H DUNLOP PUROFORT THERMO S5 boots** -50 °C, sizes nº 37 to nº 48

**IP-999A hasta IP-999M Botas DUNLOP PUROFORT FOODPRO MULTIGRIP S4**, tallas nº 37 hasta nº 50

**IP-999A to IP-999M DUNLOP PUROFORT FOODPRO MULTIGRIP S4 boots**, sizes nº 37 to nº 50



**IB-755** Descalzador de botas

**IB-755** Boot remover

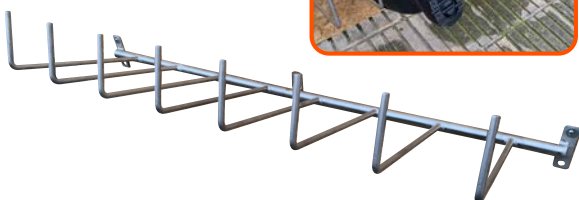

**IP-885** Colgador de acero inox, para 3 pares de botas  
**IP-887** Colgador de acero inox, para 5 pares de botas

**IP-885** Boot holder for 3 pairs, stainless steel  
**IP-887** Boot holder for 5 pairs, stainless steel

**IP-890** Colgador para botas acero inox, para 4 pares, modelo inclinado

**IP-890** Boot holder stainless steel for 4 pairs of boots, inclined model

# Instrumental quirúrgico Surgical instruments



**Hojas de bisturí**  
*Scalpel blades*

**IQ-098** Nº 12      **IQ-099D** Nº 21  
**IQ-099** Nº 10      **IQ-100** Nº 22  
**IQ-099A** Nº 11      **IQ-105** Nº 22A  
**IQ-099B** Nº 15      **IQ-110** Nº 23  
**IQ-099C** Nº 20      **IQ-110A** Nº 24

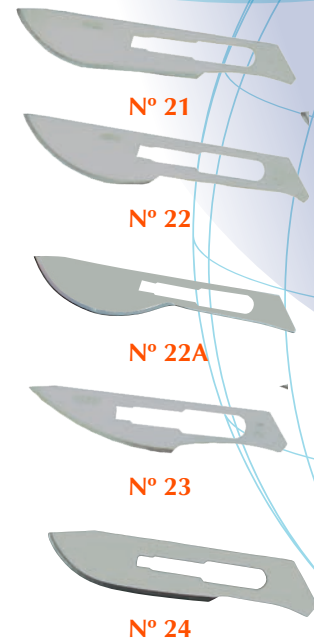

**IQ-114** Mango de bisturí plegable

*IQ-114 Foldable scalpel handle*



**IQ-113** Mango de bisturí nº 3

*IQ-113 Scalpel handle, Nº 3*



**IQ-112** Mango de bisturí nº 4

*IQ-112 Scalpel handle, Nº 4*



**DS-410** Gel solución hidroalcohólica SERBONET, 5 l

*DS-410 SERBONET 5 l hydroalcoholic solution gel*



**DS-415** Dosificador de jabón y gel aut. por infrarrojos

*DS-415 Automatic infrared soap and gel dispenser*



**IQ-115** Electrobisturí completo de 50 W

*IQ-115 Complete electrocautery unit (50 W)*



**DG-220** Toallitas desinfectantes para instrumental, bote de 150 uds

*DG-220 Disinfectant wipes for veterinary instruments, 150 units/dispenser*



**DS-402** Spray desinfectante higienizante de superficies, 400 ml

*DS-402 Surface sanitizing disinfectant spray, 400 ml*



**IQ-116** Bisturí electroquirúrgico, 100 W

*IQ-116 Electrocautery scalpel (100 W)*



**IQ-125 Tijera recta** de 14 cm aguda/aguda  
**IQ-125A Tijera recta** de 16 cm aguda/aguda

*IQ-125 14 cm straight scissors pointed/pointed*  
*IQ-125A 16 cm straight scissors pointed/pointed*



**IQ-120 Tijera curva** de 14 cm aguda/aguda  
**IQ-120A Tijera curva** de 16 cm aguda/aguda

*IQ-120 14 cm curved scissors pointed/pointed*  
*IQ-120A 16 cm curved scissors pointed/pointed*



**IQ-135 Tijera recta** de 14 cm aguda/roma  
**IQ-135A Tijera recta** de 16 cm aguda/roma

*IQ-135 14 cm straight scissors pointed/blunt*  
*IQ-135A 16 cm straight scissors pointed/blunt*



**IQ-130 Tijera curva** de 14 cm aguda/roma  
**IQ-130A Tijera curva** de 16 cm aguda/roma

*IQ-130 14 cm curved scissors pointed/blunt*  
*IQ-130A 16 cm curved scissors pointed/blunt*



**IQ-145 Tijera recta** de 14 cm roma/roma  
**IQ-145A Tijera recta** de 16 cm roma/roma

*IQ-145 14 cm straight scissors blunt/blunt*  
*IQ-145A 16 cm straight scissors blunt/blunt*

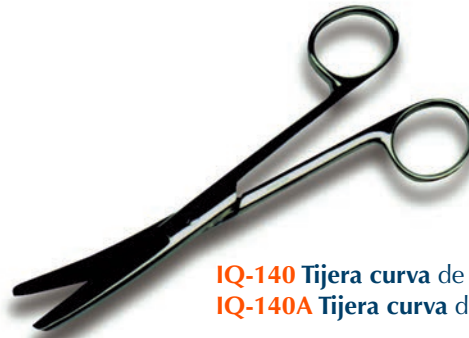

**IQ-140 Tijera curva** de 14 cm roma/roma  
**IQ-140A Tijera curva** de 16 cm roma/roma

*IQ-140 14 cm curved scissors blunt/blunt*  
*IQ-140A 16 cm curved scissors blunt/blunt*



**IQ-150 Tijera recta** de 20 cm aguda/roma

*IQ-150 20 cm straight scissors pointed/blunt*



**IQ-150A Tijera curva** de 20 cm aguda/roma

*IQ-150A 20 cm curved scissors pointed/blunt*



**IQ-151 Tijera recta** de 20 cm aguda/aguda

*IQ-151 20 cm straight scissors pointed/pointed*



**IQ-151A Tijera curva** de 20 cm aguda/aguda

*IQ-151A 20 cm curved scissors pointed/pointed*

# Instrumental quirúrgico Surgical instruments



**IQ-160 Tijera recta MAYO-STILLE** de 17 cm

**IQ-160** 17 cm MAYO-STILLE *scissors, straight*



**IQ-155 Tijera curva MAYO-STILLE** de 17 cm

**IQ-155** 17 cm MAYO-STILLE *scissors, curved*



**IQ-185 Tijera recta METZENBAUM** de 17 cm

**IQ-185** 17 cm METZEMBAUM *scissors, straight*

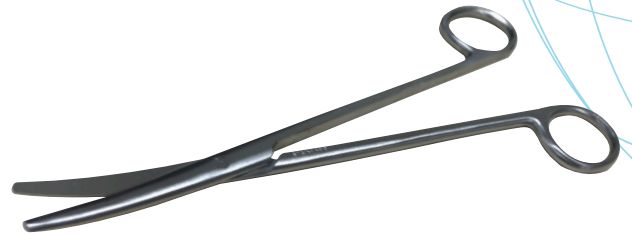

**IQ-184 Tijera METZENBAUM** de 17 cm curva

**IQ-184** 17 cm METZEMBAUM *scissors, curved*



**IQ-165 Tijera LISTER para vendaje** de 14 cm

**IQ-165** 14 cm LISTER bandage *scissors*



**IQ-170 Tijera LISTER para vendaje** de 18 cm

**IQ-170** 18 cm LISTER bandage *scissors*



**IQ-186 Tijera JESCO** de 18 cm

**IQ-186** 18 cm JESCO *scissors*



**IQ-190 Tijera recta IRIS** de 11 cm

**IQ-191 Tijera curva IRIS** de 11 cm

**IQ-190** 11 cm IRIS *straight scissors*

**IQ-191** 11 cm IRIS *curved scissors*



**IQ-180 Tijera SPENCER** para quitar puntos de 9 cm

**IQ-175 Tijera LITTAUER** para quitar puntos de 14 cm

**IQ-180** 9 cm SPENCER *scissors* for suture removal

**IQ-175** 14 cm LITTAUER *scissors* for suture removal



**Pinza Kocher**  
*Kocher forceps*

**IQ-200** 16 cm con dientes, curva  
**IQ-220** 18 cm con dientes, curva

**IQ-200** 16 cm with teeth, curved  
**IQ-220** 18 cm with teeth, curved



**Pinza Kocher**  
*Kocher forceps*

**IQ-199** 15 cm con dientes, recta  
**IQ-205** 16 cm con dientes, recta  
**IQ-225** 18 cm con dientes, recta

**IQ-199** 15 cm with teeth, straight  
**IQ-205** 16 cm with teeth, straight  
**IQ-225** 18 cm with teeth, straight



**Pinza Kocher**  
*Kocher forceps*

**IQ-210** 16 cm sin dientes, curva  
**IQ-230** 18 cm sin dientes, curva

**IQ-210** 16 cm without teeth, curved  
**IQ-230** 18 cm without teeth, curved



**Pinza Kocher**  
*Kocher forceps*

**IQ-215** 16 cm sin dientes, recta  
**IQ-235** 18 cm sin dientes, recta

**IQ-215** 16 cm without teeth, straight  
**IQ-235** 18 cm without teeth, straight



**IQ-640** Bandeja acero inox para instrumental 27x20x4

**IQ-640** Stainless steel tray for instruments 27x20x4

# Instrumental quirúrgico

## Surgical instruments



**IQ-265 Pinza recta** mosquito sin dientes

*IQ-265 Mosquito forceps without teeth, straight*



**IQ-260 Pinza curva** mosquito sin dientes

*IQ-260 Mosquito forceps without teeth, curved*



**IQ-255 Pinza recta** mosquito con dientes

*IQ-255 Mosquito forceps with teeth, straight*



**IQ-250 Pinza curva** mosquito con dientes

*IQ-250 Mosquito forceps with teeth, curved*



**IQ-245 Pinza recta** CRILE de 14 cm

**IQ-240 Pinza curva** CRILE de 14 cm

*IQ-245 14 cm CRILE forceps, straight*

*IQ-240 14 cm CRILE forceps, curved*



**IQ-285 Pinza** PEAN de 14 cm

*IQ-285 14 cm PEAN forceps*



**IQ-275 Pinza recta** intestinal de 23 cm

*IQ-275 23 cm intestinal forceps, straight*



**IQ-270 Pinza curva** intestinal de 23 cm

*IQ-270 23 cm intestinal forceps, curved*



**IQ-280** Pinza ALLIS de 15 cm

**IQ-280** 15 cm ALLIS forceps



**Pinza tipo cocodrilo HARTMANN**

*HARTMANN crocodile forceps*

**IQ-345** 13 cm

**IQ-346** 8 cm

**IQ-344** 13 cm, extrafina

**IQ-345** 13 cm

**IQ-346** 8 cm

**IQ-344** 13 cm (Thinner model)



**IQ-539A** Plexímetro para veterinaria

**IQ-539A** Veterinary pleximeter



**IQ-650** Estuche de instrumental veterinario para 10 piezas (estuche vacío)

**IQ-650** Empty case for 10 veterinary instruments

Los estuches pueden ser personalizados con el instrumental veterinario que deseen

Cases can be personalized with the veterinary instruments you require



**IQ-325** Pinza campo cangrejo, SCHAEDEL de 9 cm

**IQ-325** SCHAEDEL towel clamp, 9 cm

**IQ-330** Pinza BACKHAUS de 9 cm

**IQ-330** 9 cm BAKHAUS forceps



**IQ-435** Sonda acanalada

**IQ-435** Grooved director



**IQ-539** Martillo percutor TRÖMMER

**IQ-539** TRÖMMER striker hammer



**IQ-538** Martillo percutor TAYLOR

**IQ-538** TAYLOR striker hammer

**IQ-655** Estuche de instrumental veterinario con 10

piezas, compuesto de:

- Pinza de disección de 13 cm, sin dientes
- Pinza Pean de 14 cm
- Mango de bisturí de nº 4
- Tijera de 14 cm, aguda/roma recta
- Pinza Adson sin dientes
- Pinza mosquito sin dientes recta
- Tijera Spencer para quitar puntos de 9 cm
- Hoja de bisturí nº 22
- Portaguas de Mathieu de 18 cm
- Pinza Felchenfelt para espinas

**IQ-655** Veterinary instruments case. Composed of ten items:

- 13 cm dissection forceps
- 14 cm Pean forceps
- Scalpel handle, n.4
- 14 cm scissors, pointed/blunt, straight
- Adson dissection forceps
- Mosquito forceps, straight
- 9 cm Spencer suture scissors
- Scalpel blade, n.22
- Mathieu needle-holder, 18 cm
- Fenchenfelt splinter forceps

# Instrumental quirúrgico Surgical instruments



**Pinza para panza BLENDING**  
*BLENDING paunch forceps*

**IQ-365** 20 cm con gancho  
**IQ-370** 20 cm sin gancho

*IQ-365* 20 cm, with hook  
*IQ-370* 20 cm, without hook



**Pinza para útero** cabeza goma  
*Uterus forceps with rubber top*

**IQ-340** 28 cm  
**IQ-341** 16 cm

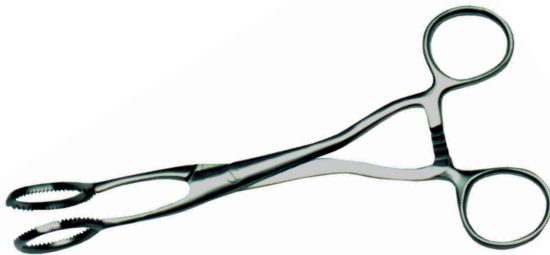

**IQ-355** Pinza tira lenguas COLLING de 17 cm

*IQ-355* COLLING tongue forceps, 17 cm



**IQ-315** Pinza ADSON sin dientes

*IQ-315* ADSON dissection forceps



**Pinza para oído, según LUCAE**  
*LUCAE ear forceps*

**IQ-337** 16 cm  
**IQ-338** 14 cm



**Pinza de disección** sin dientes  
*Dissection forceps*

**IQ-286** 13 cm  
**IQ-295** 16 cm  
**IQ-305** 20 cm



**IQ-310** Pinza ADSON con dientes

*IQ-310* ADSON dissection forceps with teeth



**Pinza para oído** acodada  
*Elbow ear forceps*

**IQ-335** 16 cm  
**IQ-336** 14 cm



**Pinza de disección**  
*Dissection forceps*

**IQ-290** 16 cm con dientes de 1x2  
**IQ-291** 16 cm con dientes de 2x3  
**IQ-292** 18 cm con dientes de 2x3

*IQ-290* 16 cm with teeth (1 x 2)  
*IQ-291* 16 cm with teeth (2 x 3)  
*IQ-292* 18 cm with teeth (2 x 3)



**Pinza de disección** con dientes  
*Dissection forceps with teeth*

**IQ-287** 13 cm  
**IQ-300** 20 cm



**IQ-320** Pinza para espinas  
FELCHENFELT

*IQ-320* FELCHENFELT splinter forceps



**IO-170** **Espéculo vaginal** desechable  
**IO-175** **Espéculo vaginal** desechable, mini

**IO-170** Disposable *vaginal speculum*  
**IO-175** Disposable *vaginal speculum, mini*



**Espéculo vaginal** POLANSKY  
*POLANSKY vaginal speculum*

**IQ-537** 37 cm  
**IQ-537A** 27 cm



**Espéculo vaginal** con mango de iluminación  
*Vaginal speculum with illumination handle*

**IQ-536C** 120 x 20 mm  
**IQ-536** 250 x 30 mm  
**IQ-536A** 350 x 40 mm  
**IQ-536B** 420 x 50 mm



**IQ-530** **Espéculo vaginal y nasal** KILLIAN

**IQ-530** KILLIAN *vaginal and nasal speculum*



**IQ-535** **Espéculo vaginal y nasal** HARTMANN

**IQ-535** HARTMANN *vaginal and nasal speculum*

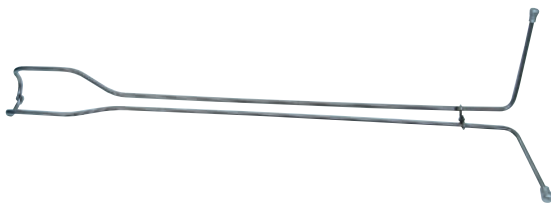

**IO-114** **Forceps** obstétricos modelo danés de, 52 cm

**IO-114** *Obstetric forceps* danish model, 52 cm



**IO-115** **Forceps** obstétricos, según WITT, de 52 cm

**IO-115** WITT *obstetric forceps*, 52 cm



**IO-164** **Hisopo** veterinario LARYNGEAL extralargo 27 cm, paq. 100

**IO-164** LARYNGEAL extra large veterinary *swab* 27 cm. Bag with 100 pcs



**IO-160** **Hisopo** estéril de 15 cm para recogida de muestras (con medio de cultivo)

**IO-161** **Hisopo** estéril de 15 cm para recogida de muestras (sin medio de cultivo)

**IO-160** Sterile *swab* (15 cm) to obtain samples (With transport medium)

**IO-161** Sterile *swab* (15 cm) to obtain samples (Without transport medium)

# Instrumental quirúrgico / Obstetricia

## Surgical instruments / Obstetrics



**IO-145 Tenaza** HAUPTNER para ágrafes de sutura

**IO-140 Ágrafes** HAUPTNER grandes niquelados, paquete de 100 unidades

**IO-145** HAUPTNER suture wire ring **applicator**

**IO-140** HAUPTNER large **wire rings**, nickel-plated, 100 units package



**IO-120 Cierre vaginal** HAUPTNER, completo

**IO-120** HAUPTNER complete **vaginal closing**

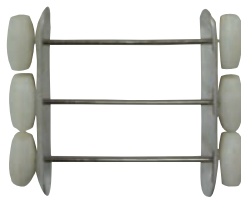

**Cierre vaginal**  
**Vaginal closing**

**IO-117** 60 mm

**IO-118** 80 mm

**IO-119** 100 mm



**Imperdible vaginal**  
**Vaginal needles**

**IO-121** Grande

**IO-121** Large

**IO-121A** Mediano

**IO-121A** Medium

**IO-121B** Pequeño

**IO-121B** Small



**IO-116A** Guía para lazo  
corredizo según sand 17,5 cm

**IO-116A** Sand rope carrier, 17.5 cm

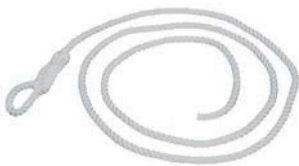

**IO-129** **Cuerda** larga para partos de  
1,8 m x 12 mm, un nudo

**IO-129** Long perlon **rope**, 1.8 m x 12 mm,  
one loop

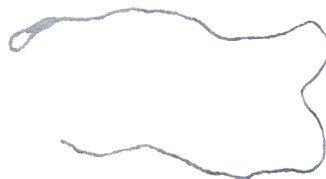

**IO-126** **Cuerda** larga para partos de  
2 m x 7 mm, un nudo

**IO-126** Long perlon **rope**, 2 m x 7 mm,  
one loop

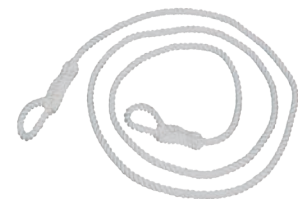

**Cuerda** larga para partos, dos nudos  
Long perlon **rope**, double loop

**IO-127** 1,8 m x 12 mm

**IO-128** 1,9 m x 9 mm



**IO-129** **Ayuda partos** para ganado vacuno

**IO-129** Cattle **labour's help**



**IO-124** **Cuerda** corta para partos

**IO-124** Short perlon **rope**



**IN-123 Correa** para prolapsos de vacas

*IN-123 Prolapse rope for dairy cows*

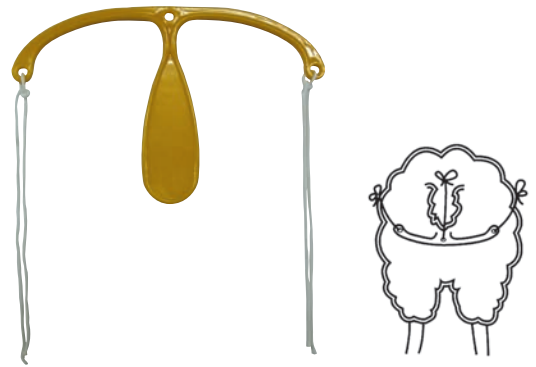

**IO-122 Prolapso** para ovino con cuerdas de sujeción

*IO-122 Sheep prolapse with fastening ropes*

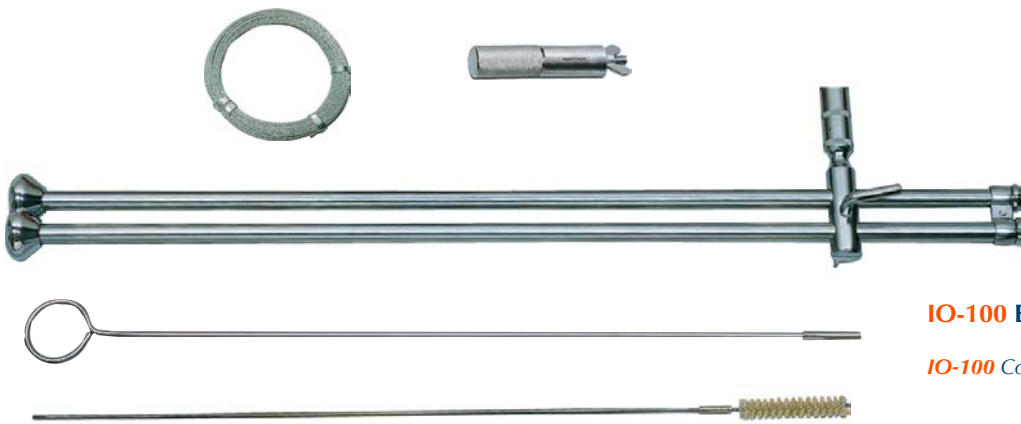

**IO-100 Embriotomo completo** HAUPTNER

*IO-100 Complete HAUPTNER embriotome*



**IO-110 Gancho** obstétrico romo

**IO-105 Gancho** obstétrico HARMS agudo

*IO-110 Obstetric blunt hook*

*IO-105 HARMS obstetric pointed hook*



**IO-112 Escalpel** LINDE de 11 cm

*IO-112 LINDE scalpel, 11 cm*



**IO-123 Arnés** para prolapso ovino

*IO-123 Harness for sheep prolapse*

**IO-113 Gancho** KREY-SCHOTTLER

*IO-113 KREY-SCHOTTLER hook*





**IQ-395 Separador WEITLANER** de 13 cm  
**IQ-400 Separador WEITLANER** de 16 cm

**IQ-395** 13 cm WEITLANER retractor  
**IQ-400** 16 cm WEITLANER retractor



**IQ-430** Juego de separadores ROUX

**IQ-430** ROUX retractor set



**Separadores FARABEUF**  
**FARABEUF retractor**

**IQ-405** Grandes, juego de 2  
**IQ-406** Pequeños, juego de 2

**IQ-405** Large set (pair)  
**IQ-406** Small set (pair)



**Separador VOLKMANN**  
**VOLKMANN retractor**

**IQ-410** 2 garfios agudos  
**IQ-410A** 2 garfios romos

**IQ-410** 2 hooks pointed  
**IQ-410A** 2 hooks blunt



**Separadores VOLKMANN**  
**VOLKMANN retractor**

**IQ-415** 3 garfios agudos  
**IQ-415A** 3 garfios romos  
**IQ-420** 4 garfios agudos  
**IQ-420A** 4 garfios romos

**IQ-415** 3 hooks pointed  
**IQ-415A** 3 hooks blunt  
**IQ-420** 4 hooks pointed  
**IQ-420A** 4 hooks blunt



**IQ-705 Martillo** para autopsias de 22,5 cm, mango de madera

**IQ-705** Autopsy **hammer**, 22.5 cm, wooden handle



**IQ-700 Martillo** para autopsias LUCAE de 25 cm, mango metálico

**IQ-700** Autopsy **LUCAE hammer**, 25 cm metallic handle



**IQ-718 Cuchillo** para autopsias de 27 cm  
**IQ-718** 27cm autopsy **knife**



**IQ-710 Serrucho** para autopsias de 23 cm (hoja de 14 cm)

**IQ-710** Autopsy **handsaw**, 23 cm (14 cm blade)



**IQ-715 Sierra** para autopsias de 39 cm (hoja de 25 cm)

**IQ-715** Autopsy **saw**, 39 cm (25 cm blade)



**IQ-725 Cureta** cortante doble VOLKMANN de 15 x 10 mm, de 20 cm

**IQ-725** Double **cutting** VOLKMANN curette, 15 x 10 mm, 20 cm



**IQ-720 Cureta** cortante VOLKMANN de 15 x 10 mm, de 17 cm

**IQ-720** VOLKMANN cutting **curette**, 15 x 10 mm, 17 cm



**IQ-690** Kit completo para autopsias

**IQ-690** Complete autopsy kit

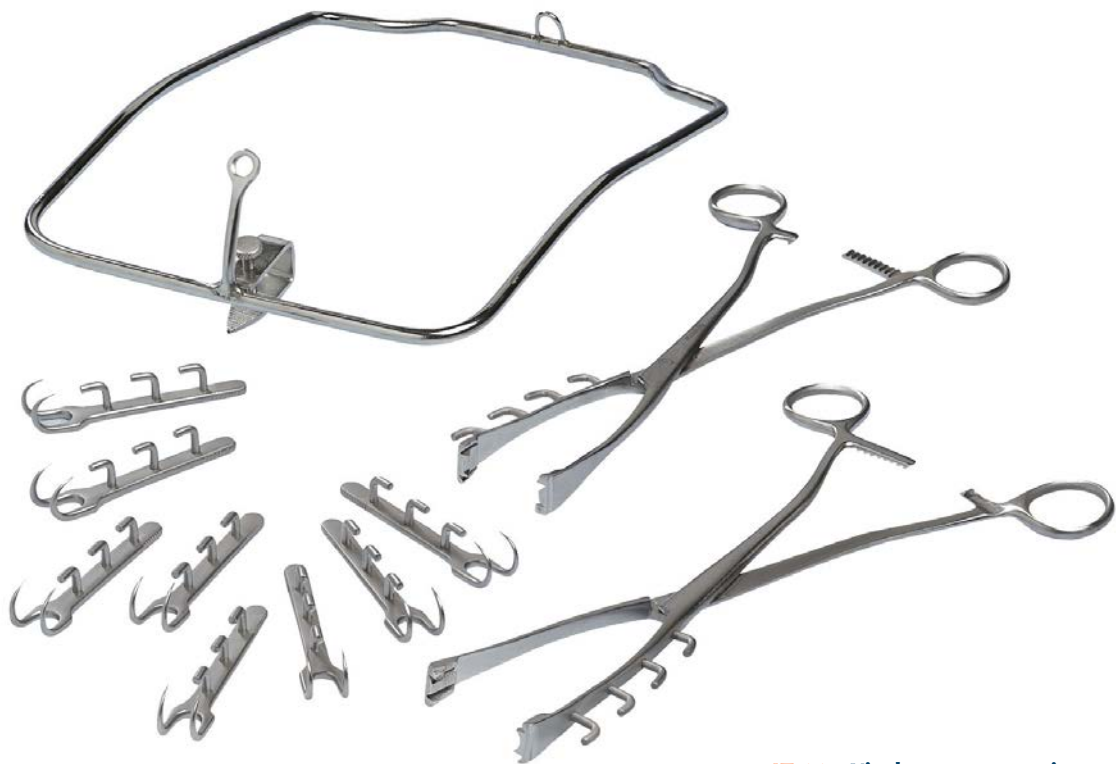

**IT-117** Kit de rumenotomia completo

**IT-117** Completet rumetnotomy kit

# Instrumental quirúrgico

## Surgical instruments

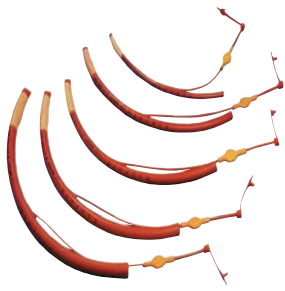

**Sondas endotraqueales con balón**  
*Endotracheal probes with olive-tip*

**PA-450** 4 mm    **PA-450C** 7 mm  
**PA-450A** 5 mm    **PA-450D** 8 mm  
**PA-450B** 6 mm    **PA-450E** 9 mm



**PA-455** Juego de conectores para sondas endotraqueales

*PA-455 Set of connectors for endotracheal probes*

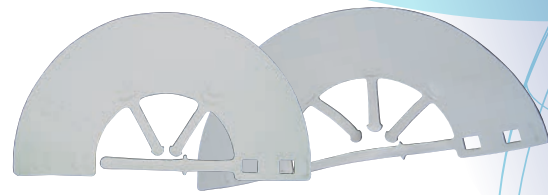

**Cabezal protector / Protecting head**

**PA-100** 7,5 cm    **PA-120** 20 cm  
**PA-105** 10 cm    **PA-125** 25 cm  
**PA-110** 12,5 cm    **PA-130** 30 cm  
**PA-115** 15 cm



**PA-425** Mesa de quirófano eléctrica regulable, 1.300 x 600 x 450 - 1.000 cm

*PA-425 Adjustable electric operating table, 1,300 x 600 x 450 x 1,000 cm*

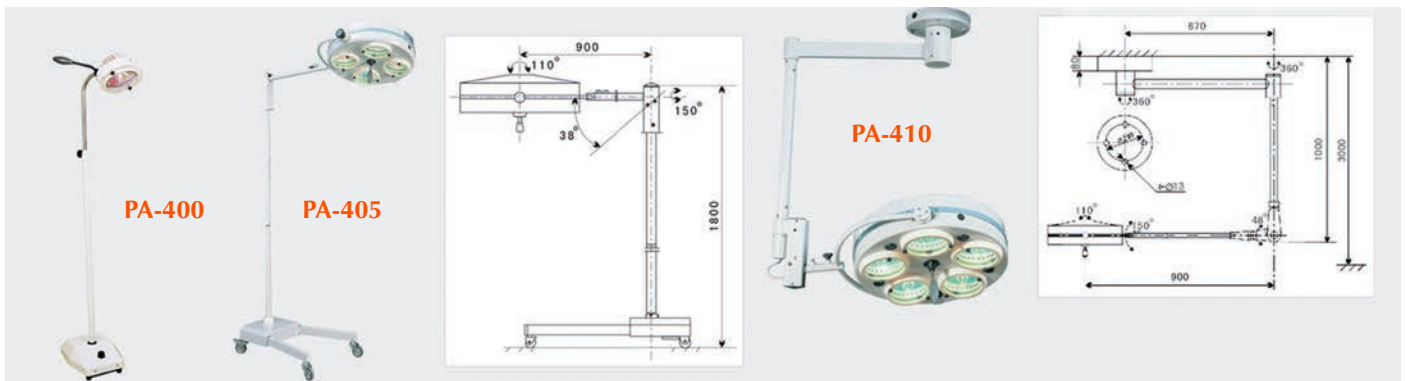

**PA-400** Lámpara quirófano de pie, de un foco con luz fría  
**PA-405** Lámpara quirófano de pie, de cuatro focos con luz fría  
**PA-410** Lámpara quirófano de techo, de cinco focos con luz fría

*PA-400 Stand lamp for operation room, 1 cold light bulb*  
*PA-405 Stand lamp for operation room, 4 cold light bulbs*  
*PA-410 Ceiling lamp for operation room, 5 cold light bulbs*

Modelo <i>Model</i>	Intensidad de la luz <i>Intensity of light</i>	Temperatura de color <i>Color temperature</i>	Ajuste de gama de iluminación del campo <i>Adjustment range of illuminated field</i>	Rango de ajuste vertical <i>Range of vertical adjustment</i>	Díámetro de foco <i>Diameter of lamphead</i>	Red de suministro <i>Mains supply</i>	Consumo de energía <i>Power consumption</i>
	(en distancia de 1 m) <i>(at 1 m distance)</i>	(K)	( $\varnothing$ mm)	(mm)	( $\varnothing$ mm)	(V/Hz)	(W)
PA-400	20	3,000+-500	100-150	600	/	220/50	50
PA-405	40	4,000+-500	100-200	400	500	220/50	100
PA-410	50	4,000+-500	100-200	400	500	220/50	125



**IQ-500** Otoscopio GOWLLANDS

*IQ-500 GOWLLANDS otoscope*



**IQ-505** Otoscopio-oftalmoscopio GOWLLANDS

*IQ-505 GOWLLANDS otoscope-ophthalmoscope*



**IQ-508** Equipo completo de diagnóstico GOWLLANDS Oto-oftal-larin

*IQ-508 GOWLLANDS complete set: otoscope, ophthalmoscope and laryngoscope*

**IQ-525** Vídeo-oscopio-otoscopio completo con tres camaras de vídeo

*IQ-525 Video otoscope-endoscope complete with 3 cams*



**IQ-555** Fonendoscopio Phonendoscope



**IQ-550**

**IQ-540**  
**IQ-545**

*IQ-540 1 membrane*

*IQ-545 Double membrane*

*IQ-550 NISSEI RAPPAPORT*

*IQ-555 HAUPTNER*

**IQ-540** Una membrana  
**IQ-545** Doble membrana  
**IQ-550** NISSEI RAPPAPORT  
**IQ-555** HAUPTNER



**IQ-480** Fórceps de extracción dental rectos

**IQ-485** Fórceps de extracción dental universales

*IQ-480 Tooth forceps, straight*

*IQ-485 Tooth forceps, universal*



**Cortaorejas para perros**  
*Ear notcher for dogs*

**IQ-610A** 9,5 cm, recto  
**IQ-610** 14 cm, recto  
**IQ-615** 14 cm, curvo

*IQ-610A 9.5 cm, straight*  
*IQ-610 14 cm, straight*  
*IQ-615 14 cm, curved*

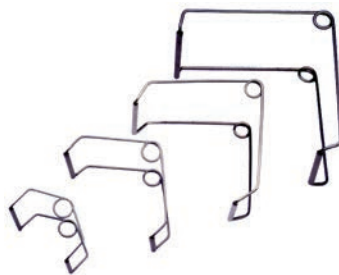

**PA-270** Juego de abre bocas SMITH-BAXTER

*PA-270 SMITH-BAXTER mouth gag kit*



**Abrebocas**  
*Mouth gag*

**PA-250** 6 cm, para gatos  
**PA-260** 11 cm, para perros  
**PA-265** 16 cm, para perros

*PA-250 6 cm, for cats*  
*PA-260 11 cm, for dogs*  
*PA-265 16 cm, for dogs*

# Instrumental quirúrgico Surgical instruments

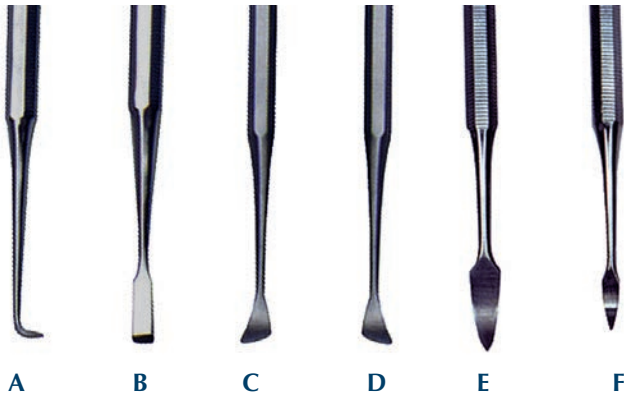

**IQ-475 Raspador dental** para perros (varias medidas)  
*IQ-475 Dental scaler for dogs (several sizes)*



**PA-206 Tijeras cortaúñas** de 18,5 cm, para perros  
*PA-206 18.5 cm nail clipper for dogs*



**PA-207 Lima** para uñas de perros a pilas  
*PA-207 Battery powered nail trimmer for dogs*



**PA-205 Tijeras cortaúñas** para gatos  
*PA-205 Nail clipper for cats*



**PA-210 Cortaúñas** para pequeños animales tipo guillotina  
*PA-210 Nail cutters for small animals with guillotine action*



**IQ-495 Pulsioxímetro** portátil veterinario  
*IQ-495 Veterinary portable pulse oximeter*

**IA-712 Alcohol 96°** botella de 1l.  
**IA-713 Alcohol 70°** botella de 1l.

*IA-712 Alcohol 96° bottle 1l.*  
*IA-713 Alcohol 70° bottle 1l.*



**DS-845 Spray INTRA DERMA** de 100 ml.  
*DS-845 INTRADERMA spray of 100 ml*



**IS-588 Rasuradora desechable** no estéril de 2 hojas, paq. de 100 unds  
*IS-588 Non-sterile 2-blade disposable razor, pack of 100 units*



**IA-712A POVIDONA YODADA** de 500 ml  
*IA-712 POVIDONE IODINE of 500 ml*



**IS-590** Grapadora de sutura precargada con 35 grapas (estéril)

**IS-595** Pinza extractora de grapas (estéril)

*IS-590 Suture stapler with 35 staples (sterile)*

*IS-595 Staple extracting forceps (sterile)*



**PA-220** Bastoncillos de algodón para orejas, tamaño L/XL, paq. 30 uds.

**PA-222** Bastoncillos de algodón para orejas, tamaño S/M, paq. 30 uds.

*PA-220 Cotton swabs for ears, size L/XL, pack of 30 units*

*PA-222 Cotton swabs for ears, size S/M, pack of 30 units*



**IT-220** Botella biberón de 500 ml, para pequeños animales

*IT-220 Feeding bottle for small animals, 500 ml*



**PA-650** Comedero-bebedero maxi para perro, de 265 mm ø

*PA-650 Feeder-drinker maxi for dogs, 265 mm Ø*



**PA-660** Comedero-bebedero para gatos, de 160 mm ø

*PA-660 Feeder-drinker for cats, 160 mm Ø*



**PA-150** CACACAN, paq. de 25 uds.

**PA-155** Expositor con 25 sobres

*PA-150 CACACAN, box of 25 units*

*PA-155 Display with 25 cards*



**PA-225** Pinza para extracción de garrapatas

*PA-225 Tick remover*



**IT-190** Tetina para pequeños animales

*IT-190 Teat for small animals*



**Venda elástica adhesiva**  
*Elastic adhesive bandage*

**PA-330** 10 cm x 4,5 m

*PA-330 10 cm x 4.5 m*



**PA-395** Vendaje para ubres de vacas de 6x5 m

*PA-395 6x5 m Teat bandage for cow udders*



**Venda cohesiva**  
*Cohesive bandages*

**PA-275** 6 cm x 4 m

**PA-280** 8 cm x 4 m

**PA-285** 10 cm x 4 m



**PA-390** Venda de alquitrán de 25 m

*PA-390 25 m KROMBERG tar bandage*



**PA-365** Venda sintética poliéster blanca, 10 cm x 3,6 m

*PA-365 White polyester synthetic bandage, 10 cm x 3.6 m*



**Venda de gasa**  
*Gauze bandages*

**PA-385** 10 cm x 10 m. G-7

**PA-385A** 10 cm x 10 m. LYS

**PA-385B** 10 cm x 10 m. CAMBRIC

# Vendas cohesivas INSERTFIX

*INSERTFIX cohesive bandages*



**PA-315** De 5 x 450 cm, paquete de 12 unidades

**PA-315** 5 x 450 cm, box of 12 units



**PA-320** De 7,5 x 450 cm, paquete de 12 unidades

**PA-320** 7.5 x 450 cm, box of 12 units



**PA-325** De 10 x 450 cm, paquete de 12 unidades

**PA-325** 10 x 450 cm, box of 12 units

# Vendas cohesivas / Suturas

## Cohesive bandages / Sutures



**SUPRAMID**, paq. de 36 sobres, con aguja curva  
**SUPRAMID**, box of 36 envelopes, with curved needle

- IS-163E** N° 2
- IS-163F** N° 000
- IS-163G** N° 00
- IS-163H** N° 0
- IS-163I** N° 1

**SUPRAMID**, paq. de 36 sobres, con aguja recta  
**SUPRAMID**, box of 36 envelopes, with straight needle

- IS-163B** N° 00 con aguja recta
- IS-163B** n. 00 with straight needle



**Seda trenzada**, paq. de 12 sobres  
**Braided silk**, box of 12 envelopes

- IS-153** N° 00
- IS-153A** N° 0
- IS-154** N° 1
- IS-154A** N° 2
- IS-155** N° 3-4
- IS-155B** N° 5
- IS-155C** N° 6



**Seda trenzada**, paq. de 12 sobres, con aguja recta  
**Braided silk**, box of 12 envelopes, with straight needle

- IS-160** N° 1
- IS-160B** N° 2
- IS-161** N° 0000
- IS-161A** N° 000
- IS-161B** N° 00
- IS-161C** N° 0

**Seda trenzada**, paq. de 12 sobres, con aguja curva  
**Braided silk**, box of 12 envelopes, with curved needle

- IS-160A** N° 1
- IS-160C** N° 2
- IS-161D** N° 0000
- IS-161E** N° 000
- IS-161F** N° 00
- IS-161G** N° 0



**Ac. poliglicólico (PGA)**, paq. de 12 sobres  
**Polyglycolic acid suture**, box of 12 pcs

Sobre de 140 cm  
**140 cm envelope**

- IS-115** N° 0
- IS-120** N° 1
- IS-125** N° 2

Sobre de 70 cm con aguja  
**70 cm envelope, with needle**

- IS-130** N° 0
- IS-135** N° 1
- IS-140** N° 2

**Carrete estéril catgut**  
*Sterile cassette catgut*

- 75 m
- IS-165 N° 00
- IS-170 N° 0
- 50 m
- IS-175 N° 1
- IS-180 N° 2
- IS-190 N° 3-4
- 25 m
- IS-192 N° 5
- IS-195 N° 6



**PGA en carrete estéril**  
*Sterile cassette PGA*

- IS-196E N° 5
- IS-196F N° 6

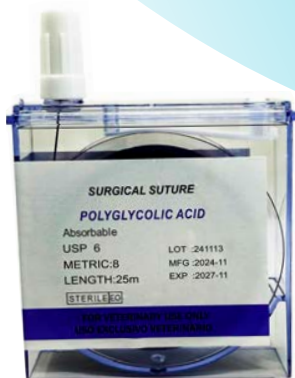

**Carrete estéril SUPRAMID**  
*Sterile cassette SUPRAMID*

- 50 m
- IS-245 N° 00
- IS-250 N° 0
- IS-255 N° 1
- IS-280 N° 3-4 40 mts (Blanco / White)
- IS-286 N° 6 - 25 mts (Blanco / White)
- 25 m
- IS-260 N° 2
- IS-283 N° 5
- IS-285 N° 6



**Seda trenzada carrete estéril**  
*Sterile braided silk cassette*

- 100 m
- IS-200 N° 000
- IS-205 N° 00
- IS-211 N° 0
- IS-215 N° 1
- 50 m
- IS-220 N° 2
- IS-236 N° 5
- 25 m
- IS-230 N° 3-4
- 40 m
- IS-241 N° 6
- 30 m
- IS-242 N° 7



**Seda trenzada**  
*Braided silk*

- 50 m
- IS-290 N° 00
- IS-295 N° 0
- IS-300 N° 1
- IS-305 N° 2
- IS-315 N° 3-4
- IS-320 N° 5
- IS-325 N° 6
- 10 m
- IS-330 N° 00
- IS-335 N° 0
- IS-340 N° 1
- IS-345 N° 2
- IS-352 N° 3-4
- IS-360 N° 5
- IS-364 N° 6

**IS-367 Cinta para sutura vaginal de 5 m**

*IS-367 Vaginal suture tape, 5 m*



**IO-145 Tenaza HAUPTNER para ágrafas de sutura**  
**IO-140 Ágrafas HAUPTNER grandes niqueladas, paq. de 100 uds**

*IO-145 HAUPTNER suture wire ring applicator*  
*IO-140 HAUPTNER large wire rings, nickel-plated, 100 units Package*



**IS-590 Grapadora de sutura**  
*precargada con 35 grapas (estéril)*  
**IS-595 Pinza extractora de grapas (estéril)**

*IS-590 Suture stapler with 35 staples (sterile)*  
*IS-595 Staple extracting forceps (sterile)*

# Agujas de sutura especiales para veterinaria

## Suture needles for veterinary use

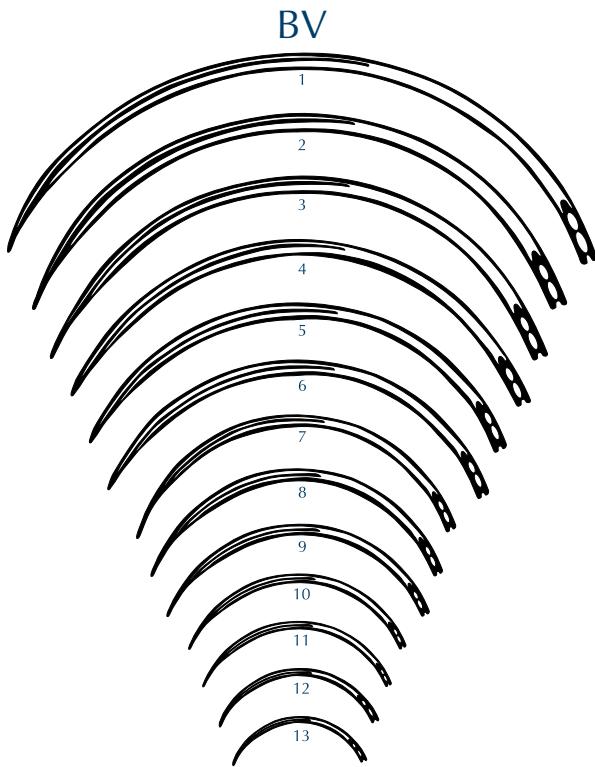

Agujas de sutura BV, paq. de 12 uds  
"BV" suture needles, box of 12 units

- |             |              |
|-------------|--------------|
| IS-900 N° 1 | IS-918 N° 8  |
| IS-902 N° 2 | IS-920 N° 9  |
| IS-905 N° 3 | IS-922 N° 10 |
| IS-907 N° 4 | IS-925 N° 11 |
| IS-910 N° 5 | IS-927 N° 12 |
| IS-912 N° 6 | IS-930 N° 13 |
| IS-915 N° 7 |              |

Agujas de sutura curvas perfil redondo  
HAUPTNER, paq. de 12 uds  
HAUPTNER curved and round suture needles,  
box of 12 units

- |               |              |
|---------------|--------------|
| IS-717 N° 000 | IS-745 N° 6  |
| IS-718 N° 00  | IS-750 N° 7  |
| IS-719 N° 0   | IS-755 N° 8  |
| IS-720 N° 1   | IS-760 N° 9  |
| IS-725 N° 2   | IS-765 N° 10 |
| IS-730 N° 3   | IS-770 N° 11 |
| IS-735 N° 4   | IS-775 N° 12 |
| IS-740 N° 5   |              |

# Material para suturas

## Suture materials

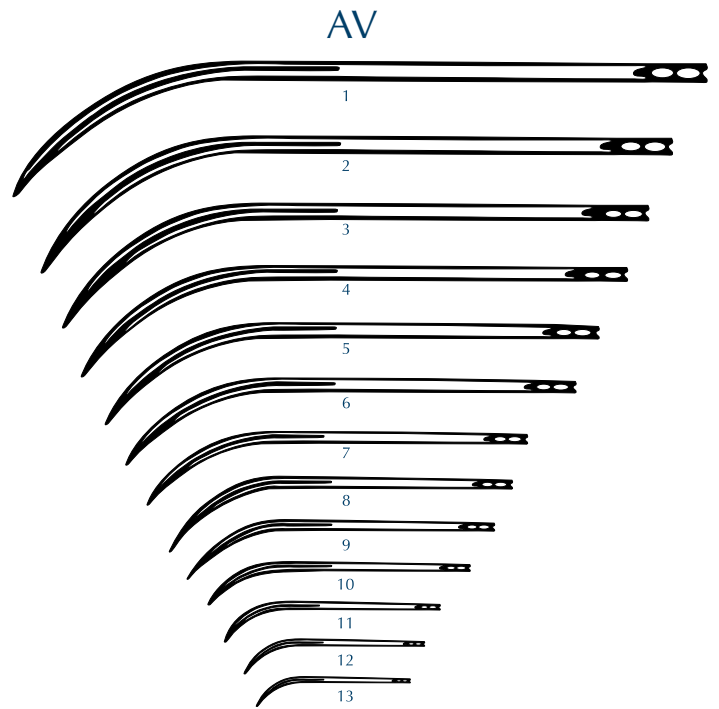

Agujas de sutura AV, paq. de 12 uds  
"AV" suture needles, box of 12 units

- |             |              |
|-------------|--------------|
| IS-935 N° 1 | IS-951 N° 8  |
| IS-936 N° 2 | IS-955 N° 9  |
| IS-940 N° 3 | IS-956 N° 10 |
| IS-941 N° 4 | IS-960 N° 11 |
| IS-945 N° 5 | IS-961 N° 12 |
| IS-946 N° 6 | IS-965 N° 13 |
| IS-950 N° 7 |              |

Tamaño Real  
Real Size

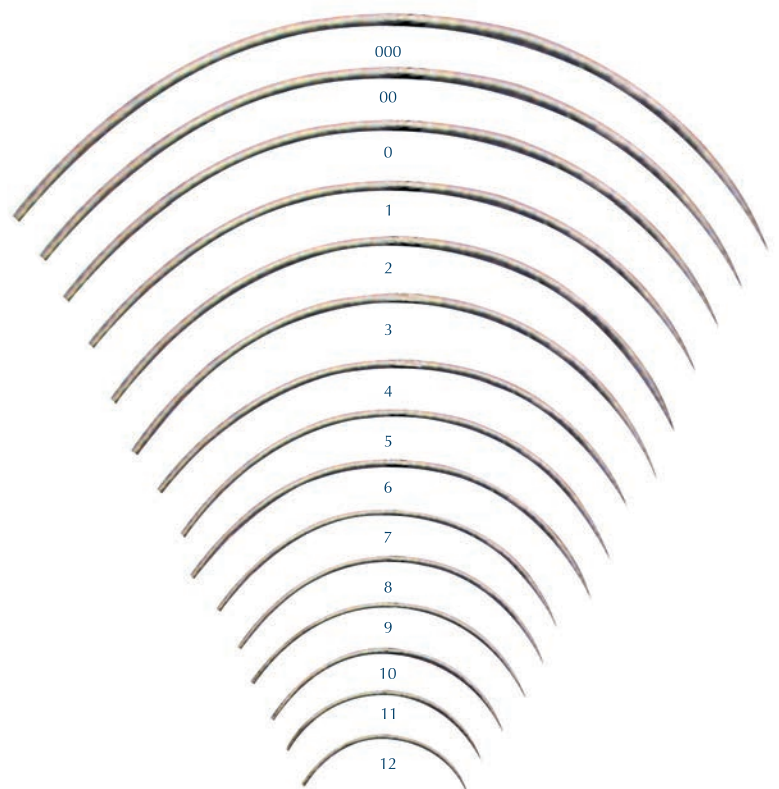

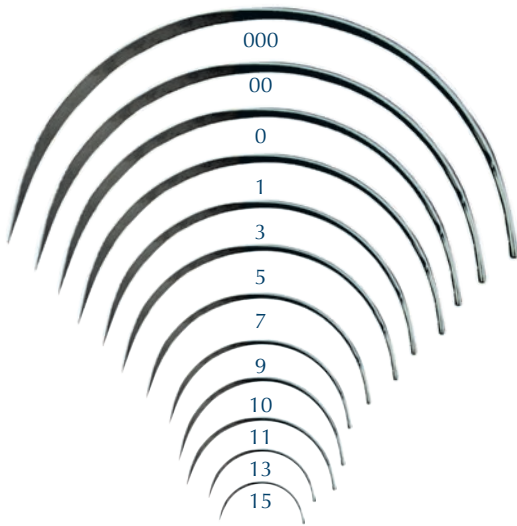

**Agujas de sutura G 1/2**, paq. de 12 uds  
*"G" suture needles, 12 units package*

- |                      |                     |
|----------------------|---------------------|
| <b>IS-414</b> N° 000 | <b>IS-435</b> N° 7  |
| <b>IS-415</b> N° 00  | <b>IS-440</b> N° 9  |
| <b>IS-416</b> N° 0   | <b>IS-442</b> N° 10 |
| <b>IS-420</b> N° 1   | <b>IS-445</b> N° 11 |
| <b>IS-425</b> N° 3   | <b>IS-450</b> N° 13 |
| <b>IS-430</b> N° 5   | <b>IS-455</b> N° 15 |

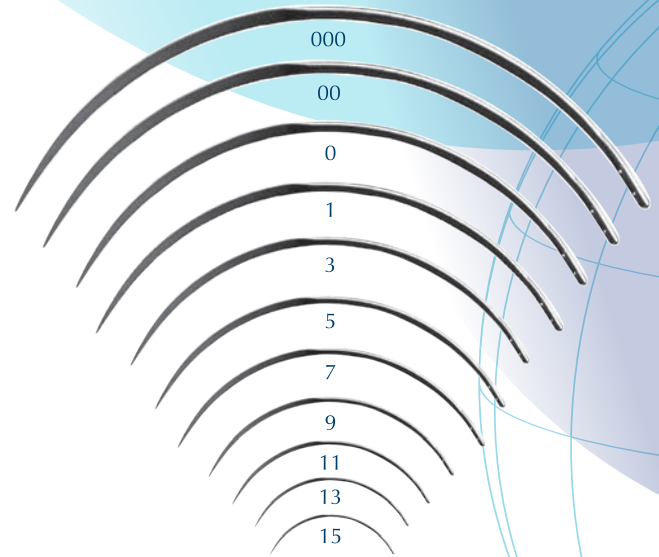

**Agujas de sutura B 3/8**, paq. de 12 uds  
*"B" 3/8 suture needles, 12 units package*

- |                      |                     |
|----------------------|---------------------|
| <b>IS-369</b> N° 000 | <b>IS-390</b> N° 7  |
| <b>IS-370</b> N° 00  | <b>IS-395</b> N° 9  |
| <b>IS-371</b> N° 0   | <b>IS-400</b> N° 11 |
| <b>IS-375</b> N° 1   | <b>IS-405</b> N° 13 |
| <b>IS-380</b> N° 3   | <b>IS-410</b> N° 15 |
| <b>IS-385</b> N° 5   |                     |

### Tamaño real *Real Size*

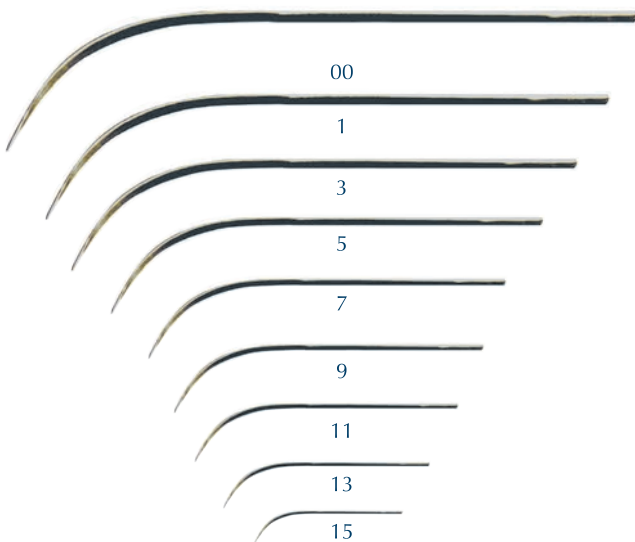

**Agujas de sutura A RC**, paq. de 12 uds  
*"A RC" suture needles, 12 units package*

- |                     |                     |
|---------------------|---------------------|
| <b>IS-460</b> N° 00 | <b>IS-485</b> N° 9  |
| <b>IS-465</b> N° 1  | <b>IS-490</b> N° 11 |
| <b>IS-470</b> N° 3  | <b>IS-493</b> N° 13 |
| <b>IS-475</b> N° 5  | <b>IS-495</b> N° 15 |
| <b>IS-480</b> N° 7  |                     |

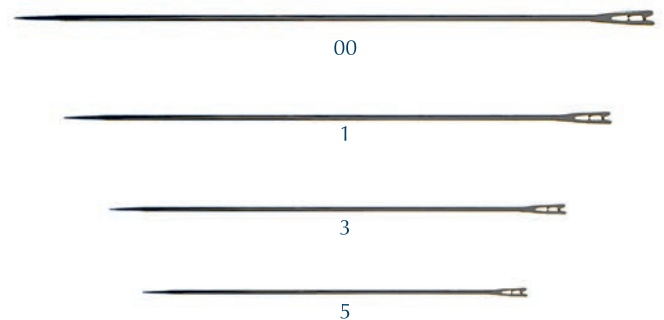

**Agujas de sutura KEITH**, paq. de 12 uds  
*KEITH suture needles, 12 units package*

- |                     |
|---------------------|
| <b>IS-500</b> N° 00 |
| <b>IS-505</b> N° 1  |
| <b>IS-510</b> N° 3  |
| <b>IS-515</b> N° 5  |

# Agujas de sutura especiales para veterinaria

# Material para suturas Suture materials

## Suture needles for veterinary use

Tamaño real  
Real Size

Agujas de sutura PM/A, paq. de 12 uds  
"PM/A" suture needles, box of 12 units

- IS-800 N° 1
- IS-805 N° 2
- IS-810 N° 3
- IS-815 N° 4
- IS-820 N° 5
- IS-825 N° 6

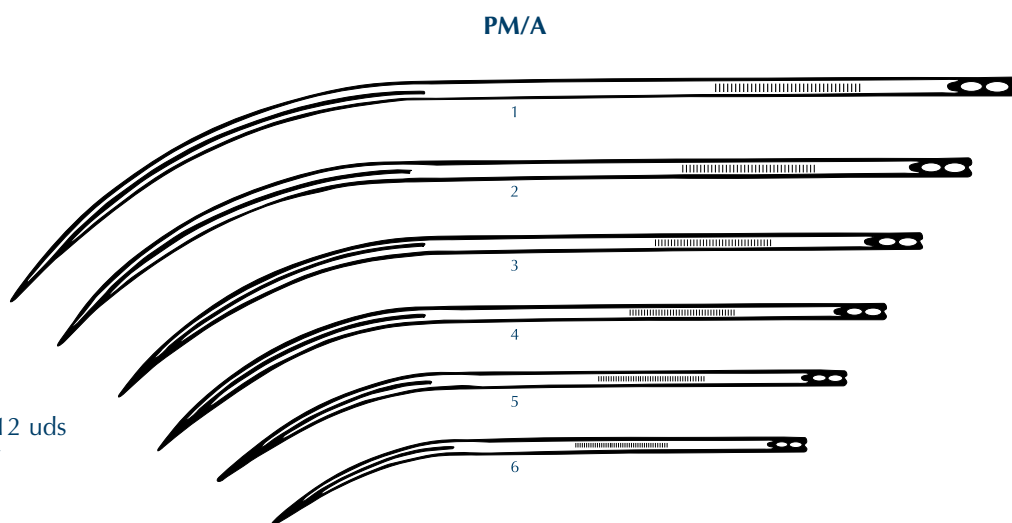

Agujas de sutura PM/S, paq. de 12 uds  
"PM/S" suture needles, box of 12 units

- IS-830 N° 1
- IS-835 N° 2
- IS-840 N° 3
- IS-845 N° 4
- IS-850 N° 5
- IS-855 N° 6

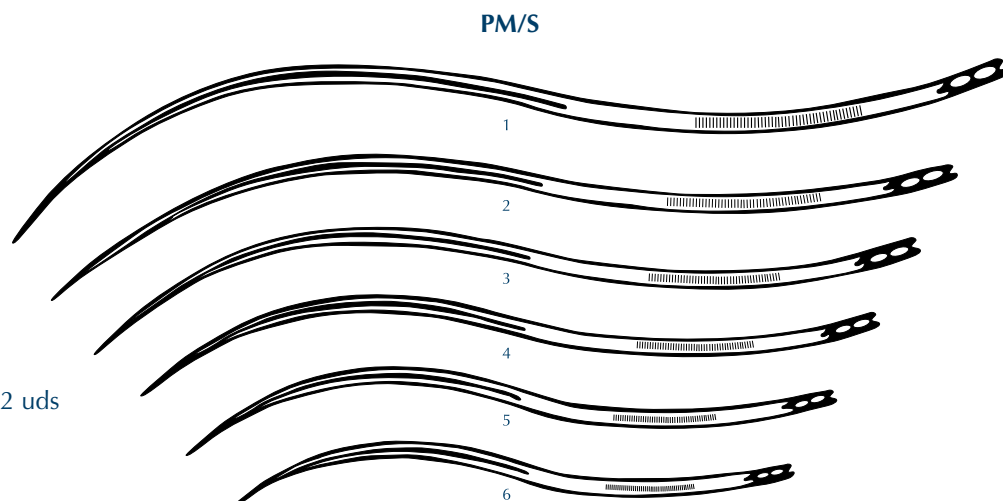

Agujas de sutura PM/K,  
paq. de 12 uds  
"PM/K" suture needles, box of 12 units

- IS-860 N° 1
- IS-865 N° 2
- IS-870 N° 3
- IS-875 N° 4
- IS-880 N° 5
- IS-885 N° 6

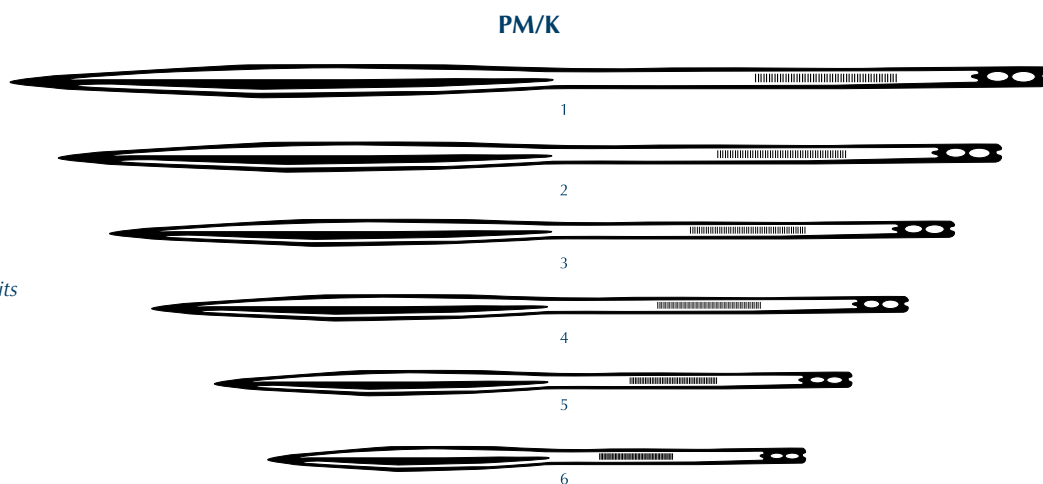

# Portaguas Needle holders



**IS-570 Portaguas** OLSEN-HEGAR con tijera de 18 cm, de boca dura (mango dorado)

**IS-571 Portaguas** OLSEN-HEGAR con tijera de 14 cm, de boca dura (mango dorado)

**IS-570** OLSEN-HEGAR scissors/**needle holder**, 18 cm with hard mouth (golden handle)

**IS-571** OLSEN-HEGAR scissors/**needle holder**, 14 cm with hard mouth (golden handle)



**Portaguas MAYO**  
MAYO **needle holder**

**IS-550** 15 cm

**IS-555** 18 cm

**IS-560** 20 cm



**IS-569 Portaguas** OLSEN-HEGAR con tijera de 19 cm

**IS-569** OLSEN-HEGAR scissors/**needle holder**, 19cm



**IS-575 Portaguas** GUILLES con tijera de 16 cm

**IS-575** GUILLES scissors/**needle holder**, 16 cm



**Portaguas MATHIEU**  
MATHIEU **needle holder**

**IS-535** 15 cm

**IS-540** 18 cm

**IS-545** 20 cm

**IS-545A** 24 cm

# Agujas para sutura

## Suture needles



**IS-520** Aguja de Gerlach de 15 cm HAUPTNER

**IS-521** Aguja de Gerlach de 15 cm

**IS-520** 15 cm *Gerlach suture needle* HAUPTNER

**IS-521** 15 cm *Gerlach suture needle*



**IS-530** Aguja para sutura de prolapso de 30 cm BUHNER

**IS-530** 30 cm prolapse *suture needle* BUHNER



**IS-525** Aguja de Gerlach de 19 cm

**IS-525** 19 cm *Gerlach needle*

**IO-145** Tenaza para ágrafes HAUPTNER

**IO-145** HAUPTNER *suture wire ring applicator*



**IO-140** Ágrafes níquelados grandes HAUPTNER, paq. de 100 uds

**IO-140** HAUPTNER *large wire rings, nickel-plated, box of 100 units*



**IS-517** Aguja para sutura REVERDIN, recta de 19,5 cm

**IS-517** REVERDIN *suture needle, straight 19.5 cm*



**IS-518** Aguja para sutura REVERDIN, curva de 19,5 cm

**IS-518** REVERDIN *suture needle, curved 19.5 cm*

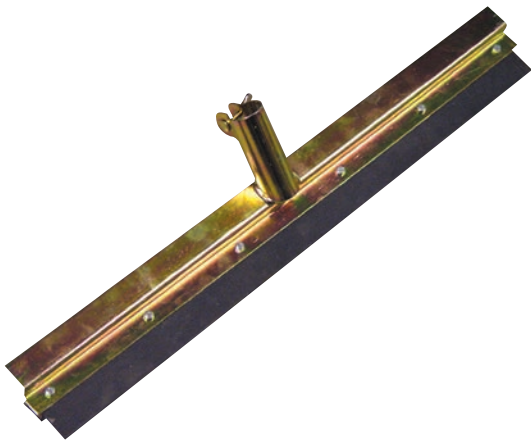

**IB-770** Limpiador recto de 60 cm

*IB-770* Straight squeegee, 60 cm

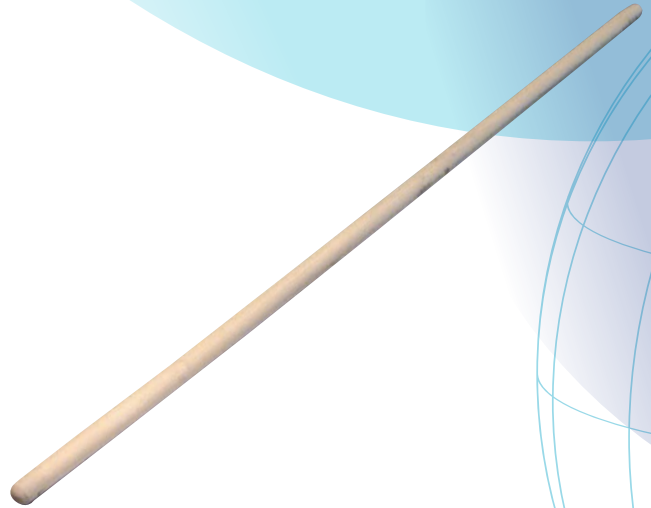

**IB-785** Mango para limpiadores de 130 cm

*IB-785* Wooden handle for scrapers, 130 cm



**IB-765** Limpiador tipo circular de 55 cm

*IB-765* Circular scraper, 55 cm



**IB-760** Limpiador tipo circular de 75 cm

*IB-760* Circular scraper, 75 cm



**IB-780** Limpiador con esquinas de 55 cm

*IB-780* Dung scraper, 55 cm



**IB-775** Limpiador con esquinas de 75 cm

*IB-775* Dung scraper, 75 cm



**DS-830** Espuma INTRA Foam Cleaner de 22 kg  
**DS-830A** Espuma INTRA Foam Cleaner bidón de 220 kg  
**DS-830B** Espuma INTRA Foam Cleaner de 1100 kg

**DS-830** INTRA Foam Cleaner, 22Kg  
**DS-830A** INTRA Foam Cleaner, 220Kg  
**DS-830B** INTRA Foam Cleaner, 1100Kg



**DS-835** Carro de limpieza y desinfección,  
 4 ruedas con válvula de 3 posiciones

**DS-835** Cleaning and disinfection trolley, 4 wheels  
 with 3-position valve



**DS-451** SERBONET detergente - desengrasante  
 - espumante de 25kg

**DS-835** SERBONET foaming-degreasing-detergent 25kg



**DS-190** Lanza limpiadora-aspiradora SPEEDY  
 para limpiar bebederos y comederos

**DS-190** SPEEDY cleaning vacuum lance to clean drinkers  
 and feeders



**DS-195** Pistola de espuma dosificable,  
 con depósito de 2 l

**DS-195** Dosable foam gun, with 2 l tank



**IA-678 Pediluvio de desinfección, 60x40 cm**

*IA-678 Disinfectant footbath, 60 x 40 cm*



**DS-815 Desinfectante INTRA MULTI-DES GA de 5 l**  
**DS-817 Desinfectante INTRA MULTI-DES GA de 20 l**

*DS-815 INTRA MULTI-DES GA Desinfectant 5 l*  
*DS-817 INTRA MULTI-DES GA Desinfectant 20 l*



**IA-676C Pediluvio acero inox doble con bandeja-muelles, 530x480x70mm de alto**

*IA-676C Double stainless steel footbath with spring tray, 530x480x70mm high*

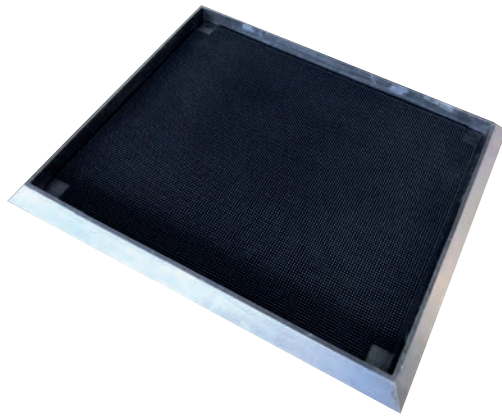

**IA-677A Pediluvio de desinfección caucho 28 l, 985 x 810 x 50 mm,**

*IA-677A Rubber disinfection footbath, 28 l, 985 x 810 x 50 mm*



**IA-676A Pediluvio acero inox con bandeja-muelles, 530x480x45mm de alto**  
**IA-676B Pediluvio acero inox con bandeja-muelles, 530x480x70mm de alto**

*IA-676A Stainless steel footbath with springs tray, 530x480x45mm high*

*IA-676B Stainless steel footbath with springs tray, 530x480x70mm high*

**Alfombra para desinfección**  
*Disinfectant rug*

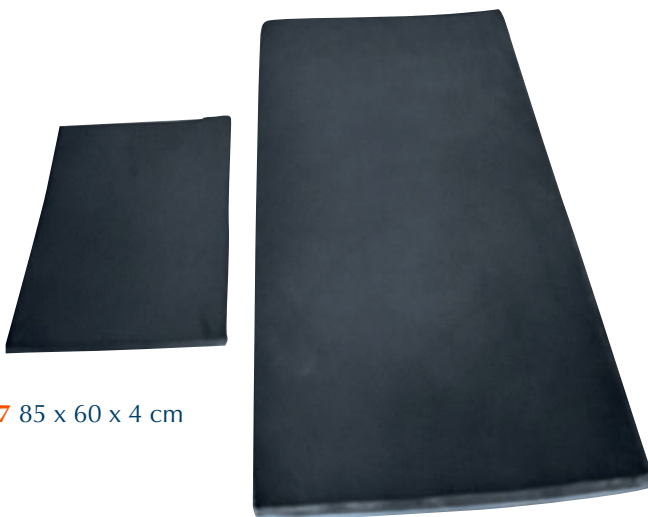

**IA-677 85 x 60 x 4 cm**

**IA-678A 180 x 90 x 10 cm**

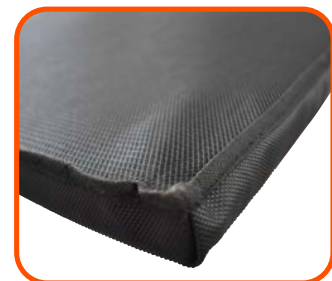

# Limpieza Cleaning



**IB-750** Limpiador de calzado desinfectante para entrada en granjas (modelo acero inoxidable)

*IB-750 Disinfectant cleaner for shoes (stainless steel model).*



**IB-751** Limpiador de calzado para entrada en granjas (modelo pintado)

*IB-751 Disinfectant cleaner for shoes (painted model)*



**IB-755** Descalzador de botas

*IB-755 Boot remover*



**DS-885** Pediluvio super-kombi para cascos (2 x 0,80 m), 200 l

*DS-885 Super-kombi footbath for hoofs (2 x 0.80 m), 200 l*



**DS-887** Pediluvio para ovino de 3000x380x190

*DS-887 Footbath for sheep 3000x380x190*



**IB-800** Cepillos con muelle para la limpieza e higiene animal

*IB-800 Brush with spring for animal cleaning*



**IB-805** Cepillos con muelle y depósito para la limpieza e higiene animal

*IB-805 Brushes with spring and tank for animal cleaning*



**IE-150 Esquiladora OSTER A-5 de 1 vel.**  
**IE-155 Esquiladora OSTER A-5 de 2 vel.**

**IE-150 OSTER A-5 clipper (1-speed)**  
**IE-155 OSTER A-5 clipper (2-speed)**



**IE-170**  
**SIZE 40**  
 corte: 0,25 mm  
 especial cirugía  
 cutting: 0.25 mm  
 for surgery use

**CABEZALES PARA ESQUILADORAS OSTER A-5 Y POWER PRO**  
**OSTER A-5 AND POWER PRO CLIPPER HEADS**



**IE-170J**  
**SIZE 50**  
 corte: 0,2 mm  
 microcirugía  
 cutting: 0.2 mm  
 microsurgery



**IE-170E**  
**SIZE 30**  
 corte: 0,5 mm  
 cara, pies, rabo  
 cutting: 0.5 mm  
 face, feet, tail



**IE-170K**  
**SIZE 15**  
 corte: 1,2 mm  
 caniches, perros  
 lanosos, uso general  
 cutting: 1.2 mm  
 caniche, big hair quantity,  
 general use



**IE-170A**  
**SIZE 10**  
 corte: 1,6 mm  
 uso general  
 cutting: 1.6 mm  
 general use



**IE-170R**  
**SIZE 10W**  
 corte: 2,4 mm  
 cara, pies, rabo  
 cutting: 2,4 mm  
 face, feet, tail



**IE-170P**  
**SIZE 9**  
 corte: 2 mm  
 acabados cortos  
 y uniformes  
 cutting: 2 mm  
 short and uniform cutting



**IE-170I**  
**SIZE 8 1/2**  
 corte: 2,8 mm  
 uso general  
 especial terriers  
 cutting: 2.8 mm  
 general use,  
 special for terriers



**IE-170B**  
**SIZE 07**  
 corte: 3,2 mm  
 cuerpo caniche,  
 terrier, cocker  
 cutting: 3.2 mm  
 caniche body,  
 terrier, cocker



**IE-170D**  
**SIZE 5**  
 corte: 6,3 mm  
 cuerpo caniche,  
 terrier, etc.  
 cutting: 6.3 mm  
 caniche, terrier body, etc...



**IE-170C**  
**SIZE 4**  
 corte: 9,5 mm  
 cuerpo, grandes  
 cantidades de pelo  
 cutting: 9.5 mm  
 body, big hair quantity



**IE-170H**  
**SIZE 7 F**  
 corte: 3,2 mm  
 acabados  
 cutting: 3.2 mm  
 finishing touch



**IE-170G**  
**SIZE 5 F**  
 corte: 6,3 mm  
 acabados  
 cutting: 6.3 mm  
 finishing touch



**IE-170F**  
**SIZE 4F**  
 corte: 9,5 mm  
 acabados  
 cutting: 9.5 mm  
 finishing touch



**IE-170M**  
**SIZE 5/8**  
 corte: 0,8 mm  
 ancho: 14 mm  
 acabados precisos  
 cutting: 0.8 mm  
 width: 14 mm  
 accurate cutting



**IE-170N**  
**SIZE 7/8**  
 corte: 0,8 mm  
 ancho: 19 mm  
 acabados precisos  
 cutting: 0.8 mm  
 width: 19 mm  
 accurate cutting

# Esquiladoras Clippers



**IE-165 Esquiladora** OSTER A-5 recargable, Power Pro

**IE-165** OSTER A-5 **clipper**, rechargeable, Power Pro



**IE-109B Esquiladora** de baterías MOSER ARCO PRO

**IE-109B** MOSER ARCO PRO battery **clipper**



**IE-162 Esquiladora** con batería de larga duración MOSER AVALON

**IE-162** MOSER AVALON **clipper** with long lasting battery



**IE-160A Esquiladora** recargable OSTER ARTISAN

**IE-160A** OSTER ARTISAN rechargeable **clipper**



**IE-161 Esquiladora** MOSER MAX 45, de dos velocidades

**IE-161** Moser MAX45 2 speeds **clipper**



**IE-163 Esquiladora** OSTER PRO 3000i, de baterías

**IE-163** OSTER PRO 3000i battery **clipper**



**IE-158 Esquiladora** ANDIS ULTRAEDGE AGC SUPER, 2 velocidades

**IE-158** ANDIS ULTRAEDGE AGC SUPER **clipper**, 2 speeds



**IE-159 Esquiladora** ANDIS a baterías PULSE ZR II (5 velocidades)

**IE-159** ANDIS battery **clipper** PULSE ZR II (5 SPEED)

\* EN ALGUNOS MODELOS DE ESQUILADORAS, EL FABRICANTE NO INCLUYE EL CABEZAL Y DEBERÁ ADQUIRIRSE APARTE  
\* IN SOME MODELS OF CLIPPERS, THE MANUFACTURER DOES NOT INCLUDE THE HEAD AND IT MUST BE PURCHASED SEPARATELY



**IE-105** Esquiladora para ovejas  
HAUPTNER

**IE-105** HAUPTNER sheep clipper



**IE-100** Esquiladora para vacas  
HAUPTNER

**IE-107** Esquiladora para caballos  
HAUPTNER

**IE-100** HAUPTNER cattle clipper

**IE-107** HAUPTNER horse clipper



**IE-145** Esquiladora para vacuno  
RINDER, de 330 W (alemana)

**IE-145** RINDER clipper for cattle, 330 w.  
(german model)



**IE-140** Esquiladora para ovejas MASTER,  
de 330 W

**IE-140** MASTER clipper for sheep, 330 w.



**IE-135** Esquiladora para vacuno y  
perros grandes CLIPMASTER

**IE-135** CLIPMASTER cattle and big dogs  
clipper



**IE-130** Esquiladora para ovejas  
SHEARMASTER

**IE-130** SHEARMASTER sheep clipper



**IE-176** Lubricante para cuchillas  
esquiladora "BLADE-LUBE"

**IE-176** "BLADE-LUBE" shearing blade  
lubricant



**IE-180** Spray limpiador/lubricante/  
refrigerante COOLSPRAY para  
esquiladora

**IE-180** Lubricant, cleaning and coolant  
spray for clippers, COOLSPRAY



**IE-175** Limpiador cabezales-cuchillas  
esquiladora BLADE-WASH

**IE-175** BLADE WASH cleaning solution for  
clipper heads



**IE-147** Cabezal esquilador colas vacuno TAILWELL 2

**IE-147** TAILWELL 2 cattle tail clipper head

# Esquiladoras Clippers



**IE-205** Esquiladora manual para ovino

*IE-205 Hand sheep clipper*



**IE-210** Esquiladora manual para vacuno

*IE-210 Hand cattle clipper*



**IE-215** Esquiladora manual dos manos para ovino

*IE-215 2 hands sheep clipper*



**IE-220** Esquiladora manual dos manos para vacuno

*IE-220 2 hands cattle clipper*



## Tijera para esquilar

**IE-200** Niquelada recta

**IE-200A** Pintada recta

**IE-201** Niquelada curva

**IE-201A** Pintada curva

## Sheep shears

**IE-200** Straight nickel-plated

**IE-200A** Straight painted

**IE-201** Curved nickel-plated

**IE-201A** Curved painted



**IE-225** Esquiladora manual minicorte estrecho

**IE-230** Esquiladora manual minicorte ancho

*IE-225 Hand clipper, narrow cutting*

*IE-230 Hand clipper, wide cutting*



**Spray para marcar ovino RAIDEX, 500 ml**  
*RAIDEX sheep marking spray*

**ID-270** Rojo / Red

**ID-271** Azul / Blue

**ID-272** Verde / Green

**ID-273** Negro / Black

**ID-274** Amarillo / Yellow

**ID-275** Violeta / Violet

**ID-275A** Rosa / Pink

**ID-275B** Naranja / Orange



**IC-146** Cortapezuñas articulado

*IC-146 Articulated hoof cutter*

**IC-148** Cortapezuñas de corte lateral de 60 cm

*IC-148 Hoof cutter, lateral cutting, 60 cm*



**IC-148A** Tenaza remachadora para pezuñas, 35 cm

*IC-148A Hoof nail clinch, 35 cm*



**IC-148B** Martillo para herraje de pezuñas con cabeza reforzada

*IC-148B Heavy duty shoeing hammer*



**PA-390** Venda de alquitrán de 25 m

*PA-390 Tar bandage, 25 m*



**IC-147** Tenaza para cascos, con dientes

*IC-147 hoof plier, with teeth*

# Cortapezuñas / Pediluvio

## Hoof knives / Footbath



**IC-145A** Legra para pezuñas

*IC-145A Hoof knife*



**IC-149** Tijera para cascos lisa

*IC-149 Non serrated hoof cutter*



**IC-149B** Tijera para cascos reforzada FELCO, mango rotativo

**IC-149BB** Tijera para cascos-pezuñas reforzada FELCO

*IC-149B FELCO hoof scissors, rotative*

*IC-149BB FELCO hoof scissors*



**IC-145D** Disco de metal para cascos, de 6 cuchillas

*IC-145D Metal disc for hoofs, 6 blades*



**Disco abrasivo para pezuñas**  
*Abrasive hoof disc*

**IC-145E** 115 mm ø

**IC-145F** 127 mm ø

**IC-145G** 178 mm ø



**IC-149A** Tijera para cascos dentada

*IC-149A Serrated hoof cutter*



**IC-135A**

**IC-140A**

**IC-143A**

**IC-141A**

**IC-142A**

**IC-135A** Legra derecha de corte doble, mango de madera (dorso cortante)

**IC-140A** Legra izquierda de corte doble, mango de madera (dorso cortante)

**IC-141A** Legra de corte derecho, mango de madera

**IC-142A** Legra de corte izquierdo, mango de madera

**IC-143A** Legra derecha de corte doble, mango de madera (total hoja)

*IC-135A Right hand knife, double sided cutting, wooden handle*

*IC-140A Left hand knife, double sided cutting, wooden handle*

*IC-141A Right hand knife, wooden handle*

*IC-142A Left hand knife, wooden handle.*

*IC-143A Right hand knife, all blade cutting, wooden handle*



**DS-880 PEDILUVIO INTRA BATH** doble 2 partes mas gradilla inox

**DS-880 INTRA BATH footbath** double 2 parts plus stainless steel rack



**DS-885 Pediluvio** super-combi para cascos, 200 l (2 x 0,80 m)

**DS-885 Super-combi footbath** 200 l (2 x 0.80 m)

**DS-887 Pediluvio** para ovino de 3000x380x190

**DS-887 Footbath** for sheep 3000x380x190

## La solución para los problemas de pezuñas THE SOLUTION FOR HOOF PROBLEMS



**DS-875 INTRA HOOF-FIT BATH** 10 l  
**DS-876 INTRA HOOF-FIT BATH** 20 l



**DS-878 INTRA HOOF-FIT BATH**  
de 10 l, "ESPECIAL OVINO"

**DS-878 INTRA HOOF-FIT** 10 l, "special sheep"



**DS-867 INTRA HOOF-FIT spray** 10 l  
**DS-868 INTRA HOOF-FIT spray** 20 l

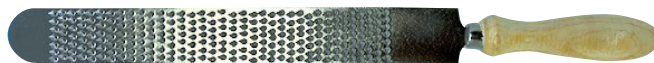

**IC-147A** Lima para cascos de 60 cm

**IC-147A** 60 cm *hoof file*



**DS-850** Spray INTRA microderm de 250 ml

**DS-850** INTRA microderm spray 250 ml



**Vendas cohesivas INSERFIX**  
*INSERFIX cohesive bandages*

**PA-325** de 10x450, azul caja de 12 u

**PA-326** de 10x450, verde caja de 12 u

**PA-325** 10x450, blue box of 12 units

**PA-326** 10x450, green box of 12 units



**DS-855** Gel INTRA Hoot-fit bote de 330 ml (incluye pincel)

**DS-855** INTRA Hoot-fit gel 330 ml bottle (includes brush)



**Destetador de plástico con cierre de palomilla**  
*Plastic milk sucking preventor with butterfly adjustment nut*

- IT-133** Pequeño / Small
- IT-133A** Mediano / Medium
- IT-133B** Grande / Large



**IT-131 Destetador de plástico sin cierre, amarillo**  
*IT-131 Yellow plastic milk sucking preventor without lock*



**IT-134A Destetador de caucho mediano**  
*IT-134A Medium rubber milk sucking preventor*



**IT-134B Destetador de caucho grande**  
*IT-134B Large rubber milk sucking preventor*



**IT-134 Destetador de caucho pequeño**  
*IT-134 Small rubber milk sucking preventor*



**IT-130 Destetador de aluminio**  
*IT-130 Aluminium milk sucking preventor*



**Destetador metálico para tenaza**  
*Metallic milk sucking preventor*

- IT-129A** Pequeño / Small
- IT-129B** Mediano / Medium
- IT-129C** Grande / Large



**IT-129 Tenaza para colocar destetadores metálicos**  
*IT-129 Metallic milk sucking preventors applicator*

## Destetadores / Narigueras Milk sucking preventors / Bull holders



**IN-117** Nariguera con muelle espiral,  
12 cm

*IN-117 Bull holder with spring, 12 cm*



**IN-114** Nariguera con muelle, 17 cm

*IN-114 Bull holder with spring, 17 cm*



**IN-110** Nariguera según HARMS

*IN-110 HARMS bull holder*



**IN-115** Nariguera para sujeción con lazo

*IN-115 Bull holder with holes to use with a rope*



**IN-112** Nariguera EISENHUT, 44 cm

*IN-112 EISENHUT bull holder, 44 cm*



**IN-113** Nariguera con mango, 44 cm

*IN-113 Bull holder with handle, 44 cm*



**Anilla nasal** niquelada  
*Nickel-plated steel nose ring*

- IN-096** 70 mm (diámetro interior)
- IN-095** 60 mm (diámetro interior)
- IN-094** 55 mm (diámetro interior)
- IN-093** 45 mm (diámetro interior)

- IN-096* 70 mm (inner diameter)
- IN-095* 60 mm (inner diameter)
- IN-094* 55 mm (inner diameter)
- IN-093* 45 mm (inner diameter)

**IN-100 Anilla nasal** HAUPTNER  
en acero pulido, 52 mm

*IN-100 HAUPTNER nose ring* 52 mm,  
*bright steel*



**IN-107 Tenaza para anilla nasal** de vacuno,  
45, 55 y 60 mm

*IN-107 Applicator for nose rings* 45, 55 and 60  
mm

**IN-119C Tenaza para ágrafes y grapas**  
HAUPTNER

*IN-119C HAUPTNER wire pig staples*  
*applicator*

**Grapas para morro cerdo** HAUPTNER  
*HAUPTNER wire pig staples*

- IN-119** Pequeñas, paq. de 100 uds
- IN-119A** Medianas, paq. de 100 uds

- IN-119* Small, box of 100 units
- IN-119A* Medium, box of 100 units



- IN-108 Tenaza** para anilla nasal de cerdo de 30 mm
- IN-109 Tenaza** para anilla nasal de cerdo de 40 mm
- IN-090 Anilla nasal** de 40 mm ø, exterior cromada
- IN-090A Anilla nasal** de 40 mm ø, exterior niquelada
- IN-092 Anilla nasal** de 30 mm ø, exterior

- IN-108 Plier* for pig nose rings, 30 mm
- IN-109 Plier* for pig nose rings, 40 mm
- IN-090 Chromed nose ring*, 40 mm outer diameter
- IN-090A Nickered nose ring* 40 mm outer diameter
- IN-092 Nose ring*, 30 mm outer diameter



**IO-146 Tenaza para ágrafes de**  
**sutura y grapas morro** n° 3 y 4,  
paq. de 100 uds

*IO-146 Wire pig staples applicator* n.3  
and n.4, box of 100 units



**Grapas para morro cerdo**  
*Wire pig staples*

- IN-118A** N° 3, paq. de 100 uds
- IN-118B** N° 4, paq. de 100 uds
- IN-118C** N° 5, paq. de 100 uds
- IN-118D** N° 6, paq. de 100 uds

- IN-118A* n.3, box of 100 units
- IN-118B* n.4, box of 100 units
- IN-118C* n.5, box of 100 units
- IN-118D* n.6, box of 100 units

**IN-118 Tenaza grapas para morro cerdo** universal

*IN-118 Universal wire pig staples applicator*

# Anillas nasales / Collares

## Nose rings / Halters



**IN-124E** Cabezada de nailon para terneros

*IN-124E Nylon halter for calves*



**IN-124F** Cabezada para terneros y vacas

*IN-124F Halter for calves and cows*



**IN-124G** Cabezada para vacas

*IN-124G Halter for cows*



**IN-124H** Cabezada para vacas con cadena

*IN-124H Halter for cows with chain*



**IN-124K** Collar sin cadena para vacas

*IN-124K Necklace without chain for cows*



**IN-124L** Collar con cadena de fijación para vacas

*IN-124L Necklace with chain for cows*

**IN-124M** Collar con cadena de doble fijación para vacas

*IN-124M Necklace with double chain for cows*

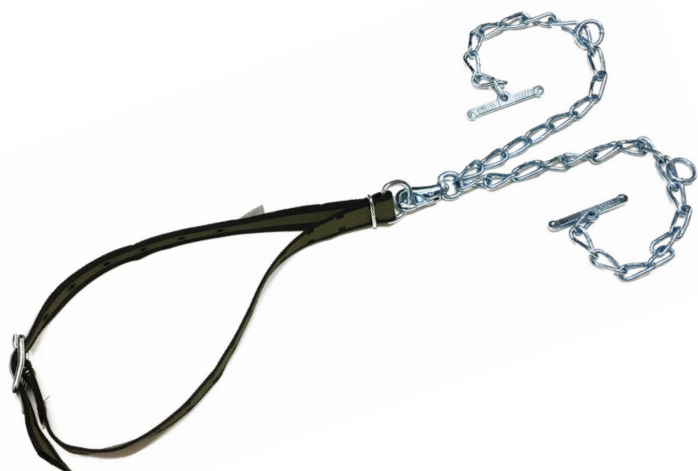

**IN-128 Elevador de vacas**

*IN-128 Cow lifter*



**IN-128C Elevador de cabezas de vacuno**

*IN-128C Cow head lifter*



**IN-128E Elevador de vacas (1.500Kg)**

*IN-128 Cow lifter (1.500Kg)*



**IN-125 Traba evitacoces**

*IN-125 Anti-kick bar*



**IT-108 Abrebocas de metal, mod. Schulze para vacuno y equino**

*IT-108 Schulze metal mouth gag for cattle and horse*



**IN-124A Pinza para sujetar patas, modelo cerrado**

*IN-124A Tendon clamp, closed model*

**IN-124 Pinza para sujetar patas, modelo abierto**

*IN-124 Tendon clamp, open model*

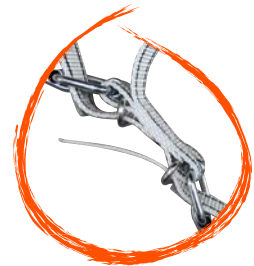

**IN-124C Trabón de nailon para sujetar patas, sin regulación**

*IN-124C Cattle hobble standard*

**IN-124D Trabón de nailon para sujetar patas, regulable**

*IN-124D Cattle hobble adjustable*

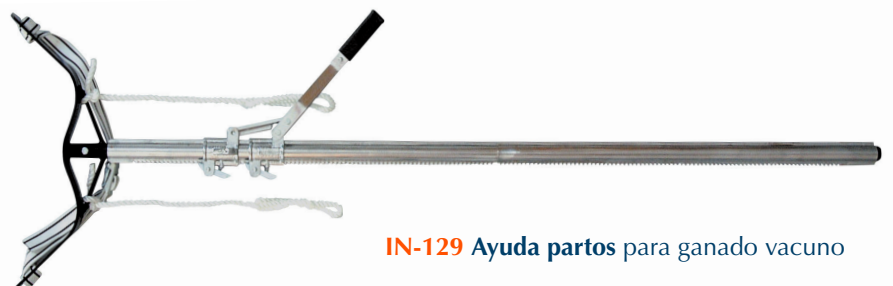

**IN-129 Ayuda partos para ganado vacuno**

*IN-129 Cattle labour's help*

# Elevadores / Trabones

## Cow lifters / Hobbles



**IN-148** Bastón metálico para sujetar patas de 95 cm  
**IN-148A** Bastón metálico para sujetar patas de 125 cm

*IN-148 95 cm leg metallic crook*  
*IN-148A 125 cm leg metallic crook*



**IN-149** Bastón metálico para sujetar cuello y patas, 135 cm

*IN-149 135 cm. leg and neck metallic crook*

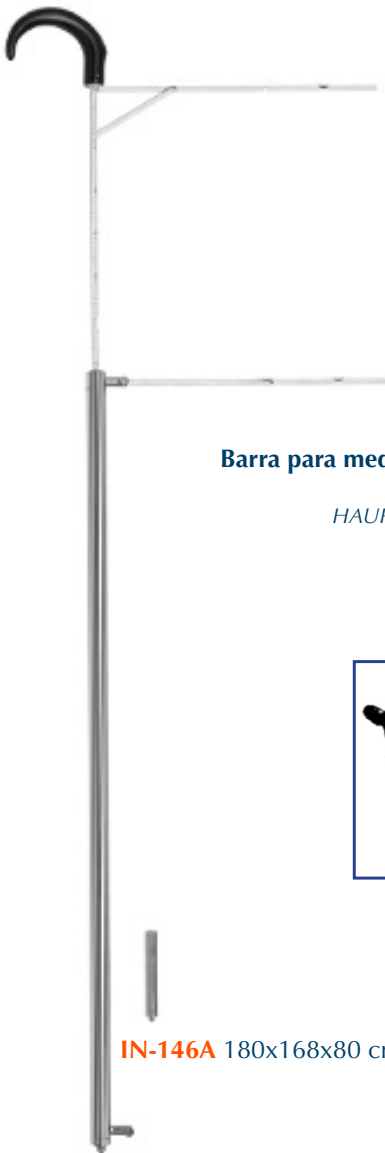

**Barra para medición de vacuno HAUPTNER**

*HAUPTNER measuring stick*

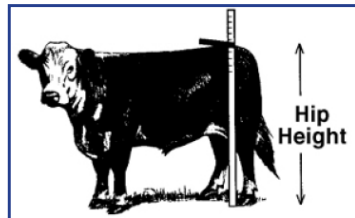

**IN-146A** 180x168x80 cm

**IN-146** 3 - 218



**IN-124B** Pinza para sujetar colas

*IN-124B Tail bridle*



**IN-145A** Contador analógico manual

*IN-145A Analog counter*



**IN-145** Cinta métrica para pesar ganado

*IN-145 Weighband for cattle and pig*





**IC-155** Sirga para cuernos, 12 m  
**IC-160** Sirga para cuernos, 3,6 m

**IC-155** Dehorning saw wire, 12 m  
**IC-160** Dehorning saw wire, 3.6 m

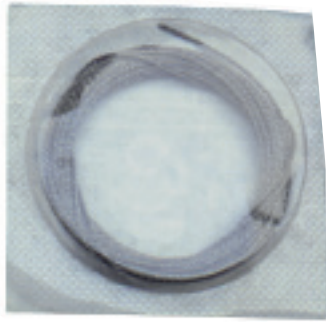

**IC-162** Mango para sirga de descornar (par)  
**IC-162** Saw wire handle (by pairs)



**Descornador manual** metálico BARNES

*BARNES metal dehorner*

**IC-153** 33 cm  
**IC-154** 43 cm

**IC-168F** Descornador a baterías completo Buddex

**IC-168F** Complete battery dehorner "Buddex"



**IC-167** Descornador portátil recargable con carga de gas

**IC-167** Portable, rechargeable dehorner with gas cartridge



# Descornadores Dehorners



**Boquillas para descornador**  
*Dehorner tips*

**IC-168C** 25 mm    **IC-168B** 20 mm    **IC-168A** 15 mm

**IC-168** Descornador eléctrico tipo revólver (incluye dos boquillas de 25 mm y 15 mm)

**IC-168** *Electric dehorner, pistol handle (with 2 tips of 25 mm and 15 mm)*



**IC-166** Lápiz cauterizador para descornar

**IC-166** *Dehorning caustic pen*



**IC-168R** Descornador eléctrico de 250 W, con boquilla de 17 mm

**IC-168R** *Electric dehorner 250W (with tip of 17 mm)*



**IC-164** Pasta para descornar en jeringa dosificadora

**IC-164** *Dehorner paste in dosing syringe*



**IC-116B** Tenaza descornadora elastrator XL para vacuno

**IC-116C** Gomas elastrator XL para vacuno, paq. de 25 uds

**IC-116B** *Elastrator XL dehorner pincers for cattle*

**IC-116C** *Elastrator XL rubber bands for cattle, pack of 25 units*



**IT-100 Trocar** de tornillo, material plástico

*IT-100 Plastic screw trocar*



**IT-105 Trocar**, mango de madera, 12 cm x 7 mm

*IT-105 Trocar*, wooden handle, 12 cm x 7 mm



**IT-106 Trocar** mango metal, 9 cm x 5 mm

**IT-107 Trocar** mango metal, 12 cm x 6 mm

*IT-106 Metal handle trocar*, 9 cm x 5 m  
*IT-107 Metal handle trocar*, 12 cm x 6 m

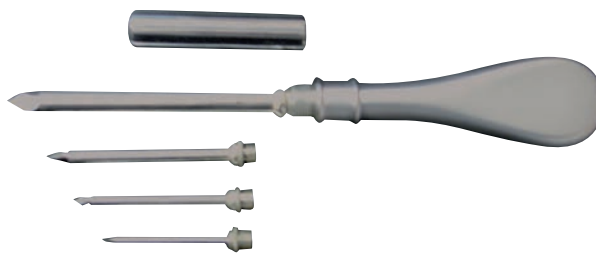

**IT-103 Trocar** universal metálico (4 tamaños en un set)

*IT-103 Universal sheep trocar* (4 sizes in one set)

**IT-120 Bomba estomacal**

*IT-120 Stomach pump*



**Sonda nasogástrica**  
*Nasal-gastric probes*

- IT-109** 9 x 2.100 mm
- IT-109A** 13 x 2.700 mm
- IT-109B** 16 x 2.700 mm
- IT-109C** 19 x 3.000 mm



**IT-115 Reanimador de terneros**

*IT-120 Calf Resuscitator*



**IT-124 Abrebocas para sonda esofágica grande**  
**IT-124A Abrebocas para sonda esofágica pequeña**

*IT-124 Mouth gag for probangs, large*  
*IT-124A Mouth gag for probangs, small*

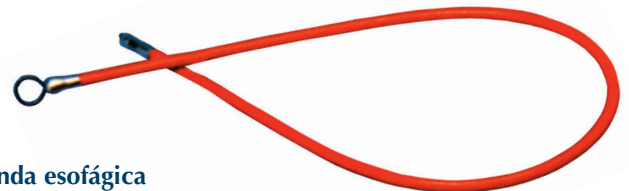

**Sonda esofágica**  
*Probangs*

- IT-123** Para vacas, 170 cm
- IT-123A** Para vacas, 170 cm con abrebocas de madera
- IT-122** Para terneros, 130 cm
- IT-122A** Para terneros, 130 cm con abrebocas de madera

*IT-123 170 cm for cows*  
*IT-123A 170 cm for cows, with wooden mouth gag*  
*IT-122 130 cm for calves*  
*IT-122A 130 cm for calves with wooden mouth gags*

# Trocars / Sondas / Imanes

## Trocars / Probes / Magnets

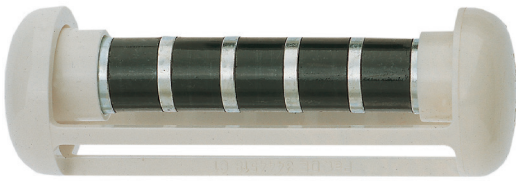

**IT-142** Imán esofágico blanco curativo MEDVET super II

*IT-142 MEDVET super II healing white ruminal magnet*

### Introduccion de imanes

#### Magnet introducer

**IT-145** Rígido STARVET

*IT-145 STARVET rigid*



**IT-146** Flexible HAUPTNER

*IT-146 HAUPTNER flexible*



**IT-147** Flexible STARVET

*IT-147 STARVET flexible*



**IT-135** Imán esofágico STARVET, forma de jaula

*IT-135 STARVET ruminal magnet, cage form*

Para prevenir y tratar la indigestión traumática del ganado debido a cuerpos extraños ferromagnéticos en la panza recomendamos la introducción de un imán STARVET antes del primer parto o a la edad de 18 meses. El imán STARVET es eficaz también en el tratamiento de ataques agudos de indigestión traumática por su capacidad de aislar cuerpos extraños magnéticos.

*In connection with prevention and treatment of traumatic indigestion with cattle-caused by ferromagnetic foreign bodies in rumen-it is recommended to introduce one STARVET magnet before first calving or at an age of 1 1/2 year. STARVET magnet is also effective in the treatment of acute attacks of traumatic indigestion through its ability to retract and isolate foreign bodies of ferromagnetic material.*





**IT-175** Cubo para corderos con 6 tetinas, 11 l

*IT-175* 11 l feeding bucket for lambs, with 6 teats



**IT-171** Válvula de aluminio para tetina corderos

**IT-172** Válvula de plástico para tetina corderos

*IT-171* Aluminium valve for lamb teat  
*IT-172* Plastic valve for lamb teat

**Tetina de recambio para corderos**  
*Lambs spare teat*



**IT-170A**



**IT-170B**

**IT-170A** Tetina de caucho calidad extra

**IT-170B** Tetina para biberón

*IT-170A* Rubber teat, extra quality  
*IT-170B* Feeding bottle spare teat



**IT-205** Botella biberón para corderos, 1 l

**IT-215** Botella biberón para corderos, 500 ml

*IT-205* Lamb feeding bottle, 1 l

*IT-215* Lamb feeding bottle, 500 ml



**IU-185** Separador de leche QUARTER MILKER, bidón de 8 l

*IU-185* QUARTER MILKER, 8 l container



**IT-230** Calentador de leche "display digital" de 2.300 W

*IT-230* Digital display milk warmer, 2.300 W.



**IT-235** Calentador de leche eléctrico de 2.300 W

*IT-235* Electric milk warmer, 2.300 W.



**IT-225A** Tetina de recambio roja, para botella de biberón de cordero

*IT-225A* Red spare teat for lamb feeding bottle



**IT-400** Carro de leche con bomba y mezclador, 170 l

*IT-400* Milk trolley with pump and mixer, 170 l



**IT-401** Carro de leche Inox con bomba, mezclador, y pasteurizador, 200 l

*IT-401* Milk trolley stainless steel with pump, mixer and pasteuriser, 200 l

# Cubos / Tetinas / Carros de leche

## Buckets / Teats / Milk trolleys



**IT-160** Cubo de plástico completo con tetina  
**IT-161** Cubo de plástico completo sin tetina

**IT-160** Complete plastic bucket, with teat  
**IT-161** Complete plastic bucket, without teat



**IT-166** Válvula completa de recambio para cubo

**IT-166** Complete spare valve for bucket



**IT-163** Soporte para cubo terneros

**IT-163** Calf bucket holder



**IT-165A** Tetina terneros de caucho calidad extra para cubo

**IT-165A** Calf rubber teat for bucket, extra quality



**IT-260** Cubo completo gris con tetina roja  
**IT-264** Tetina terneros roja para cubo gris o verde

**IT-260** Calf feeding grey bucket with red teat and valve  
**IT-264** Spare red teat for grey and green bucket



**IT-167** Tetina terneros, para cubo negro  
**IT-167A** Tetina terneros de caucho calidad extra, para cubo verde  
**IT-225** Tetina terneros de caucho extra, para botella

**IT-167** Calf teat for black bucket  
**IT-167A** Calf teat for green bucket, extra quality rubber  
**IT-225** Calf teat for bucket, extra quality rubber for bottle



**IT-262** Válvula de recambio para cubo gris

**IT-262** Spare valve for grey bucket



**IT-224** Tetina de recambio roja, para botella biberón de terneros

**IT-224** Spare red teat for milk bottle

**IT-200** Botella biberón para terneros, 1 l  
**IT-210** Botella biberón para terneros, 500 ml

**IT-200** Calf feeding bottle, 1 l  
**IT-210** Calf feeding bottle, 500 ml





**IT-275** Cubo doble naranja con asa de 10 l completo para terneros

*IT-275 Double orange bucket for calves, 10 l*

**IT-280** Tetina para cubo doble

*IT-280 Spare teat for double bucket*

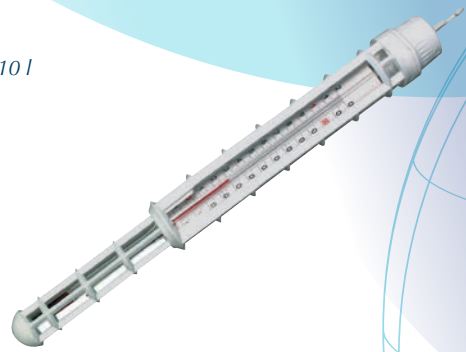

**DG-118A** Termómetro para líquidos con protector de plástico, 120 °C

*DG-118A Thermometer for liquids with plastic protection. 120 °C*



**IT-199A** Soporte para botella biberón para terneros

*IT-199A Calf feeding bottle holder*



**IT-198** Tetina para botella biberón de terneros, 2 y 3 l

*IT-198 Teat for calf feeding bottle, 2 and 3 l*



**IT-199** Botella biberón de 2 l para terneros  
**IT-199B** Botella biberón de 3 l para terneros

*IT-199 Calf feeding bottle, 2 l*  
*IT-199B Calf feeding bottle, 3 l*



**IT-196** Botella con válvula para terneros, 4 l

*IT-196 Feeding bottle with valve for calves, 4 l*



**IT-180** Tetina flotante para terneros

*IT-180 Floating calf dummy*

**IT-185** Recambio para tetina flotante

*IT-185 Spare teat for floating dummy*



# Cubos / Tetinas / Biberones

## Buckets / Teats / Feeding bottles



**IT-380 Tetina de terneros negra Milk Bar**  
**IT-380A Tetina terneros negra para Milk Bar**  
 (con posición)

**IT-380 Milk Bar black calf teat**  
**IT-380A Milk Bar black calf teat** (with position)



**IT-380**



**IT-380A**



**Cubo alimentador de leche Milk Bar**

*Milk Bar freeder bucket*

**IT-375** de 6 tetinas 36 l  
**IT-376** de 10 tetinas 60 l  
**IT-377** de 12 tetinas 90 l

**IT-375** 6 teat 36 l  
**IT-376** 10 teat 60 l  
**IT-377** 12 teat 90 l



**Cubo alimentador de leche Milk Bar**

*Milk Bar freeder bucket*

**IT-385** de 5 compartimentos 12,5 l  
**IT-386** de 10 compartimentos 25 l

**IT-385** 5 compartment 12,5 l  
**IT-386** 10 compartment 25 l



**IT-370** Cubo alimentador Milk Bar Nodriza 20 tetinas 120 L.

**IT-370** Milk Bar freeder bucket Nurse 20 teats 120L.

**IT-390** Alimentador con separación de terneros azul de 5 tetinas

**IT-390** 5 teat blue calf split feeder



**IT-285** Kit de ordeño manual para ovino-caprino

**IT-285** Sheep and goat milking pump



**Filtros para leche cosidos**

*Milk filters socks stitched*

**IT-295** 250 x 57/60 mm, caja de / box of 250 uds / pcs

**IT-300** 320 x 57/60 mm, caja de / box of 250 uds / pcs

**IT-305** 455 x 57/60 mm, caja de / box of 250 uds / pcs

**IT-307** 455 x 75/78 mm, caja de / box of 200 uds / pcs

**IT-310** 530 x 57/60 mm, caja de / box of 250 uds / pcs

**IT-315** 620 x 57/60 mm, caja de / box of 250 uds / pcs

**IT-316** 620 x 75/78 mm, caja de / box of 200 uds / pcs

**IT-321** 820 x 75/78 mm, caja de / box of 200 uds / pcs

**IT-322** 610 x 95/98 mm, caja de / box of 200 uds / pcs



**Jarra de plástico para leche**  
*Plastic jar for milk*

**IA-567** 2 l

**IA-569** 3 l

**IA-568** 5 l



**IT-325** Filtros para leche 200 mm ø, caja de 200

**IT-327** Filtros para leche 240 mm ø, caja de 200

**IT-325** Milk filters 200 mm ø, box of 200 pcs

**IT-327** Milk filters 240 mm ø, box of 200 pcs



**IT-340** Colador de leche completo en aluminio, 300 ml

**IT-340** Aluminium milk strainer, 300 ml



**IT-341** Juego de filtros colador de leche

**IT-341** Milk strainer spare filters set



**IT-350** Kit 10 bolsas calostro + tetina + sonda

*IT-350* Kit 10 colostrum bags + teat + probe

**IT-360** Manta abrigo térmico terneros premium de 70cm

*IT-360* Premium thermal blanket-coat for calves of 70cm



**AG-308** Sonda para calostro lechones/lechales

*AG-308* Colostrum probe for piglets and calves

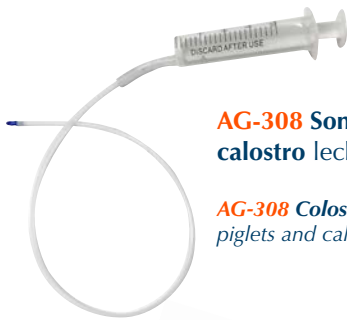

**IT-125** Calf drencher con sonda flexible 2 l

*IT-125* Calf drencher with flexible probe



**IT-218** botella biberón 250 ml con sonda para calostro de corderos

*IT-218* Feeding bottle 250 ml with probe for colostrum lambs



**IT-128D** Botella de 4 l speedy drencher con sonda y válvula

*IT-128D* 4 l speedy drencher bottle with probe and valve



**IT-127** Calf drencher con sonda rígida 2 l

*IT-127* Calf drencher with rigid probe



**IT-128B** Calf drencher profi 4 l, con sonda flexible 105 cm

*IT-128B* Calf drencher profi 4 l with flexible probe 105 cm



**IU-130 Evacuador de tetas**  
sistema danés

**IU-130** Danish *teat splitter*



**IU-125 Evacuador de tetas** según  
HUG, cabeza cortante de 16cm

**IU-125** HUG *teat splitter*, 16cm cutting head



**IU-131 Evacuador de tetas** suizo

**IU-131** Swiss *teat splitter*



**Catéter FUERSTEMBERG**  
*FUERSTEMBERG catheter*

**IU-100** 2 mm  
**IU-105** 2'5 mm  
**IU-110** 3 mm

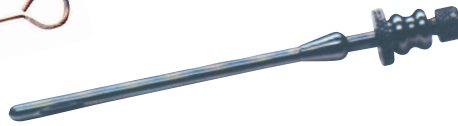

**IU-115A Cánula mamaria** BARTELS de 6 cm x 2,5 mm

**IU-120A Cánula mamaria** BARTELS de 8 cm x 2,5 mm

**IU-115A** BARTELS *teat cannula*, 6 cm x 2.5 mm

**IU-120A** BARTELS *teat cannula*, 8 cm x 2.5 mm

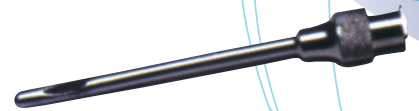

**IU-122 Cánula mamaria** metálica  
cono Luer Lock redondo, 70 mm

**IU-122** *Teat cannula*, Luer Lock, 70 mm



**IU-147 Cánulas mamarias** Luer, estériles,  
paq. de 100 uds

**IU-147** Sterile *teat cannulas*, 100 units package



**IU-112 Cánula** tipo oliva

**IU-112** Olive type *cannula*



**IU-142 Dilatador** de tetas  
DR NAYLOR

**IU-142** DR NAYLOR *teat dilator*



**IU-145 Cánulas mamarias**, 3,5 cm, paq. 10 uds

**IU-145** *Teat cannulas*, 3.5 cm, 10 units package

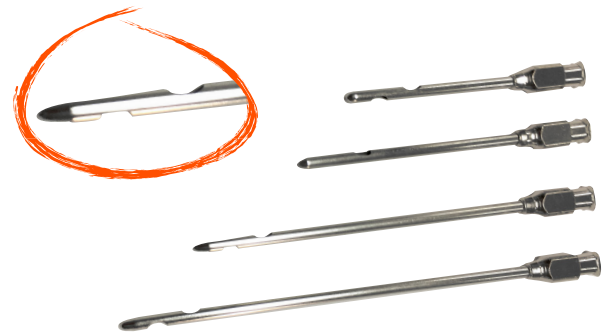

**Cánula mamaria** cono Luer Lock  
*Teat cannula*, Luer Lock

**IU-121** 40 mm

**IU-121B** 80 mm

**IU-121A** 60 mm

**IU-121C** 100 mm

**REACTIVO PARA TEST DE CALIFORNIA**  
**REAGENT LIQUIT FOR CALIFORNIA TEST**



**IU-155 Bandeja** para test de  
mamitis

**IU-155** *Paddle* for mastitis test



**IU-150 INSERBO** de 1 l

**IU-150** INSERBO, 1 l



**IU-151 BOVI-VET** de 1 l

**IU-151** BOVI-VET, 1 l



**IU-140 Papel** indicador mamitis, paq. 25 uds

**IU-140** Mastitis indicator *paper*, 25 units Package

# Cánulas mamarias / Limpieza de ubres

## Teat cannulas / Teat cleaning



**IU-205** Medidor de calostro (calostímetro)

*IU-205 Colostrum scale*



**IT-245** Silla de ordeño con asiento de plástico y cinta de sujeción

*IT-245 Milking chair with plastic seat and fastening tape*



**PA-395** Vendaje para ubres de vacas de 6x5 m

*PA-395 6x5 m Teat bandage for cow udders*



**IU-190**

**IU-195**

**IU-197**

**Botella para desinfección de pezones**  
*Teat disinfectant bottle*

**IU-190** Sin retorno, 300 ml

**IU-195** Con retorno, 300 ml

**IU-197** Ambic, acción espuma

*IU-190 Without water return, 300 ml*

*IU-195 With water return, 300 ml*

*IU-197 Ambic, foaming action*

**IT-240** Silla de ordeño con asiento de madera y cinta de sujeción

*IT-240 Milking chair with wooden seat and fastening tape*



**IU-200** Botella pulverizadora de pezones con alargo

*IU-200 Spray bottle with shaft*



**IU-160** Toallitas desinfectantes para ubres, cubo de 800 uds

*IU-160 Udder disinfectant wipes, bucket of 800 units*



**IU-138** Grasa para ubres de vacas EUTRA, 500 g

*IU-138 EUTRA milking fat, 500 g*



**IU-136** UDDERMINT 500 ml ungüento para ubres de vacas

*IU-136 UDDERMINT 500 ml for cows udders*

**IU-168** Paños de limpieza para ubres de 32 x 32 cm, paq. 48 uds

*IU-168 Udder cloth 32 x 32 cm, bag of 48 pcs*



**IU-170** Rollo de papel para limpieza de ubres

**IA-685** Portarrollos de papel de sobremesa y colgante

**IA-686** Portarrollos de papel de pie fijo

*IU-170 Roll paper for udder cleaning.*

*IA-685 Table and hanging paper roll carrier*

*IA-686 Standing paper roll carrier*





**IA-950** Inyector de 0,50 *IA-950 0.50 injector*



**IA-955** Inyector de 0,25 *IA-955 0.25 injector*



**IA-960** Inyector universal *IA-960 Universal injector*



**IA-962** Inyector universal QUICKLOCK 2000 para vainas y pajuelas

*IA-962 QUICKLOCK 2000 universal injector*



**Pajuelas**, paq. de 2.000 uds **IA-970** 0,25  
*Straws*, bags of 2,000 units **IA-975** 0,50



**IA-965** Vainas, paq. de 50 uds

*IA-965 Sheaths*, 50 units package



**IA-965A** Vainas imv beta paq. 50 unidades

*IA-965A imv beta Sheaths*, 50 units package



**IA-968** Vainas MINITUBE ranuradas tipo francés, paq. de 50 uds

**IA-968A** Vainas MINITUBE "sin ranurar", paq. de 50 uds

*IA-968 MINITUBE french type sheaths*, bag of 50 pcs  
*IA-968A MINITUBE non split sheaths*, bag of 50 pcs



**IA-980** Catéteres para lavados, paq. de 25 uds

*IA-980 Lavage catheter*, 25 units package

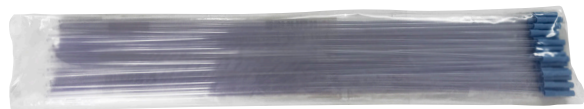

**IA-985** Catéteres para lavados de 53,5 cm, paq. de 25 uds

*IA-985 Lavage catheter*, 53.5 cm, 25 units package



**IA-978** Cortador para pajuelas

*IA-978 Straw cutter*

**IA-979** Descongelador de pajuelas 12/220 V

*IA-979 Straws defroster* 12/220 V





**IP-175 Guantes supersensitivos** de 90 cm, paq. de 100 uds

**IP-175 Supersensitive gloves** (90 cm) 100 units box

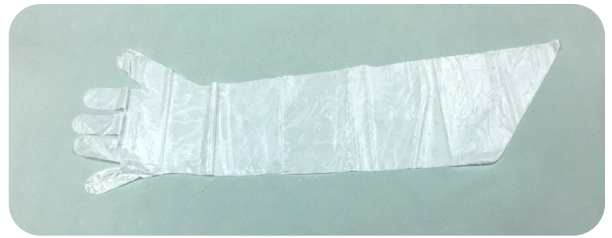

**IP-180 Guantes sensitivos** de 90 cm, paq. de 100 uds

**IP-180 Sensitive gloves** (90 cm) 100 units box



**IP-205 Guantes sensitivos naranja** de 90 cm, caja de 100 uds

**IP-205 90 cm orange sensitive gloves**, 100 units box



**IP-191 Guantes supersensitivos de protección de hombro y axila**, paq. de 50 uds

**IP-192 Guantes de protección integral supersensitivos**, paq. de 100 uds

**IP-191 Supersensitive shoulder and underarm protection gloves**, box of 50 units

**IP-192 Supersensitive full protection gloves**, box of 100 units



**Gel lubricante-desinfectante ginecológico**  
*Lubricant gel-gynecologist disinfectant*

**IA-780** 5 l

**IA-775** 1 l



**IO-138 Gel lubricante RAIDEX** 1 l

**IO-138 Lubrificant gel RAIDEX** 1 l



**Gel de exploración**  
*exploration gel*

**IO-130 BOVI-VET** 1 l

**IO-135 BOVI-VET** 500 ml

**IO-130 BOVI-VET**, 1 l

**IO-135 BOVI-VET**, 500 ml

# Guantes / Campanas Gloves / Bells



## Campana suiza de acero color bronce

- IN-450** Diámetro: 105 mm
- IN-455** Diámetro: 125 mm
- IN-460** Diámetro: 145 mm
- IN-465** Diámetro: 165 mm
- IN-470** Diámetro: 185 mm

*Swiss steel bell, bronze colour*

- IN-450** Diameter: 105 mm
- IN-455** Diameter: 125 mm
- IN-460** Diameter: 145 mm
- IN-465** Diameter: 165 mm
- IN-470** Diameter: 185 mm



## Campana suiza con símbolo

- IN-420** Diámetro: 50 mm
- IN-425** Diámetro: 57 mm
- IN-430** Diámetro: 67 mm
- IN-435** Diámetro: 75 mm
- IN-440** Diámetro: 90 mm

*Swiss bell with drawing*

- IN-420** Diameter: 50 mm
- IN-425** Diameter: 57 mm
- IN-430** Diameter: 67 mm
- IN-435** Diameter: 75 mm
- IN-440** Diameter: 90 mm



## Cencerro de acero color bronce

- IN-400** Altura: 60 mm
- IN-405** Altura: 75 mm
- IN-410** Altura: 85 mm
- IN-415** Altura: 100 mm

*Steel jangle, bronze colour*

- IN-400** Height: 60 mm
- IN-405** Height: 75 mm
- IN-410** Height: 85 mm
- IN-415** Height: 100 mm



## Campana de acero color cobre

- IN-475** De 5 x 5
- IN-485** De 12 x 13
- IN-490** De 8 x 9,5

*Steel bell, brass colour*

- IN-475** 5 x 5
- IN-485** 12 x 13
- IN-490** 8 x 9.5



# AGUJAS HIPODÉRMICAS HYPODERMIC NEEDLES

**Agujas extrafuertes (caja de 10 unds.)**  
*Extrahard needles (box of 10 units)*



Ref.	Medidas- Measures	Medidas Measures	Ref.	Medidas Measures	Medidas Measures
	L/A	A/L		L/A	A/L
AG-800	10 x 10	19G x 3/8"	AG-875	25 x 18	15G x 1"
AG-805	15 x 10	19G x 5/8"	AG-880	25 x 20	14G x 1"
AG-810	15 x 12	18G x 5/8"	AG-885	30 x 14	17G x 1 1/4"
AG-815	15 x 14	17G x 5/8"	AG-890	30 x 16	16G x 1 1/4"
AG-820	15 x 16	16G x 5/8"	AG-895	30 x 18	15G x 1 1/4"
AG-825	15 x 18	15G x 5/8"	AG-900	30 x 20	14G x 1 1/4"
AG-830	15 x 20	14G x 5/8"	AG-905	35 x 16	16G x 1 3/8"
AG-832	15 x 25	13G x 5/8"	AG-910	35 x 18	15G x 1 3/8"
AG-835	20 x 12	18G x 3/4"	AG-915	35 x 20	14G x 1 3/8"
AG-840	20 x 14	17G x 3/4"	AG-920	40 x 16	16G x 1 1/2"
AG-845	20 x 16	16G x 3/4"	AG-925	40 x 18	15G x 1 1/2"
AG-850	20 x 18	15G x 3/4"	AG-930	40 x 20	14G x 1 1/2"
AG-855	20 x 20	14G x 3/4"	AG-940	45 x 20	14G x 1 3/4"
AG-860	25 x 12	18G x 1"	AG-950	50 x 20	14G x 2"
AG-865	25 x 14	17G x 1"	AG-955	55 x 20	14G x 2 3/16"
AG-870	25 x 16	16G x 1"	AG-960	60 x 20	14G x 2 3/8"

## LISTA DE CONVERSIÓN - CONVERSION LIST



DIÁMETRO Diameter				LARGO Length			
Ømm	Øcalibre Øgauge	Ømm	Øcalibre Øgauge	mm	pulgadas Inch	mm	pulgadas Inch
0.30	30	1.00/1.10	19	3	1/8	45	1 3/4
0.35	28	1.20/1.30	18	6	1/4	50	2
0.40	27	1.40/1.50	17	8	5/16	55	2 3/16
0.45	26	1.60	16	10	3/8	60	2 3/8
0.50	25	1.80	15	13	1/2	70	3 3/4
0.55	24	2.00/2.10	14	15	5/8	75	3
0.60	23	2.40/2.50	13	20	3/4	80	3 1/4
0.70	22	2.80	12	22	7/8	90	3 1/2
0.80	21	3.00	11	25	1	100	4
0.90	20	3.50	10	30	1 1/4	110	4 1/4
---	---	4.00	8	35	1 3/8	120	4 3/4
---	---	---	---	40	1 1/2	125	5
---	---	---	---	---	---	150	6

# ACERO INOX - LUER LOCK STAINLESS STEEL

**Agujas reforzadas  
(caja de 12 unds.)  
Reinforced needles  
(box of 12 units)**



Ref. Ref.	Medidas Measures	Medidas Measures	Ref. Ref.	Medidas Measures	Medidas Measures
	L/A	A/L		L/A	A/L
AG-098	10 x 0,8	21G x 3/8"	AG-150	25 x 15	17G x 1"
AG-100	10 x 10	19G x 3/8"	AG-151	25 x 16	16G x 1"
AG-101	10 x 13	18G x 3/8"	AG-155	25 x 18	15G x 1"
AG-102	10 x 15	17G x 3/8"	AG-160	25 x 20	14G x 1"
AG-102A	13X0,6	23G x 1/2"	AG-161	25 x 25	13G x 1"
AG-103	13 x 10	19G x 1/2"	AG-163	30 x 13	18G x 1 1/4"
AG-104	13 x 13	18G x 1/2"	AG-165	30 x 15	17G x 1 1/4"
AG-104A	13 x 16	16G x 1/2"	AG-166	30 x 16	16G x 1 1/4"
AG-105	15 x 10	19G x 5/8"	AG-170	30 x 18	15G x 1 1/4"
AG-109	15 x 12	18G x 5/8"	AG-175	30 x 20	14G x 1 1/4"
AG-110	15 x 13	18G x 5/8"	AG-177	30 x 25	13G x 1 1/4"
AG-115	15 x 15	17G x 5/8"	AG-180	35 x 15	17G x 1 3/8"
AG-116	15 x 16	16G x 5/8"	AG-185	35 x 18	15G x 1 3/8"
AG-120	15 x 18	15G x 5/8"	AG-190	35 x 20	14G x 1 3/8"
AG-122	15 x 20	14G x 5/8"	AG-193	38 x 18	15G x 1 1/2"
AG-123	15 x 25	13G x 5/8"	AG-195	40 x 15	17G x 1 1/2"
AG-125	20 x 10	19G x 3/4"	AG-196	40 x 16	16G x 1 1/2"
AG-130	20 x 13	18G x 3/4"	AG-200	40 x 18	15G x 1 1/2"
AG-135	20 x 15	17G x 3/4"	AG-205	40 x 20	14G x 1 1/2"
AG-138	20 x 16	16G x 3/4"	AG-208	45 x 20	14G x 1 3/4"
AG-140	20 x 18	15G x 3/4"	AG-210	50 x 20	14G x 2"
AG-145	20 x 20	14G x 3/4"	AG-212	55 x 20	14G x 2 3/16"
AG-146	20 x 25	13G x 3/4"	AG-214	60 x 20	14G x 2 3/8"
AG-147	25 x 10	19G x 1"	AG-216	100 x 0,8	21G x 4"
AG-148	25 x 13	18G x 1"	AG-216A	100 x 20	14G x 4"
	L/A	A/L		L/A	A/L
AG-216Z	4 x 0,6	23G x 1/6"	AG-217B	5 x 0,7	22G x 1/5"
AG-217	4 x 0,7	22G x 1/6"	AG-217C	5 x 0,8	21G x 1/5"
AG-217A	4 x 0,8	21G x 1/6"	AG-217D	6 x 0,9	20G x 1/4"



## LISTA DE CONVERSIÓN - CONVERSION LIST

DIÁMETRO Diameter				LARGO Length			
Ømm	Øcalibre Øgauge	Ømm	Øcalibre Øgauge	mm	pulgadas Inch	mm	pulgadas Inch
0.30	30	1.00/1.10	19	3	1/8	45	1 3/4
0.35	28	1.20/1.30	18	6	1/4	50	2
0.40	27	1.40/1.50	17	8	5/16	55	2 3/16
0.45	26	1.60	16	10	3/8	60	2 3/8
0.50	25	1.80	15	13	1/2	70	3 3/4
0.55	24	2.00/2.10	14	15	5/8	75	3
0.60	23	2.40/2.50	13	20	3/4	80	3 1/4
0.70	22	2.80	12	22	7/8	90	3 1/2
0.80	21	3.00	11	25	1	100	4
0.90	20	3.50	10	30	1 1/4	110	4 1/4
---	---	4.00	8	35	1 3/8	120	4 3/4
---	---	---	---	40	1 1/2	125	5
---	---	---	---	---	---	150	6

# DISPONIBLE STERIMATIC PARA TODAS LAS JERINGAS HAUPTNER STERIMATIC FOR ALL HAUPTNER SYRINGES AVAILABLE



**JG-395 STERIMATIC kit completo**, con 5 tapones más adaptador para jeringa de tuberculina

**JG-395 STERIMATIC vaccination kit**, supplied with 5 caps and adapter for tuberculin syringe



## Agujas INSERBO (caja de 12 unds.) INSERBO needles (box of 12 units)



Ref.	Medidas	Medidas	Ref.	Medidas	Medidas
Ref.	Measures	Measures	Ref.	Measures	Measures
AG-400	10 x 10	19G x 3/8"	AG-452	25 x 15	17G x 1"
AG-402	10 x 15	17G x 3/8"	AG-455	25 x 18	15G x 1"
AG-405	15 x 10	19G x 5/8"	AG-460	25 x 20	14G x 1"
AG-410	15 x 13	18G x 5/8"	AG-465	30 x 15	17G x 1 1/4"
AG-415	15 x 15	17G x 5/8"	AG-470	30 x 18	15G x 1 1/4"
AG-420	15 x 18	15G x 5/8"	AG-475	30 x 20	14G x 1 1/4"
AG-422	15 x 20	14G x 5/8"	AG-480	35 x 15	17G x 1 3/8"
AG-425	20 x 10	19G x 3/4"	AG-482	35 x 18	15G x 1 3/8"
AG-430	20 x 13	18G x 3/4"	AG-485	35 x 20	14G x 1 3/8"
AG-435	20 x 15	17G x 3/4"	AG-488	40 x 15	17G x 1 1/2"
AG-440	20 x 18	15G x 3/4"	AG-490	40 x 18	15G x 1 1/2"
AG-445	20 x 20	14G x 3/4"	AG-495	40 x 20	14G x 1 1/2"
AG-450	25 x 13	18G x 1"	AG-500	50 x 20	14G x 2"



**AG-218 Aguja de tuberculina STARVET** cono Luer Lock, caja de 12 unds

**AG-218 STARVET tuberculin needles**, Luer Lock

**AG-216 Agujae STARVET**, 100 x 0,8, caja de 10 unds

**AG-216 STARVET needles**, 100 x 0.8, box of 10 pcs

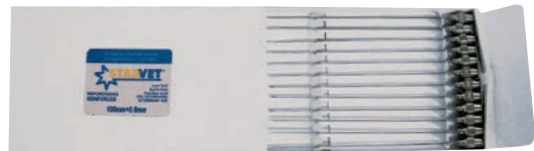

**AG-216A Agujae STARVET** Luer Lock, 100 x 20

**AG-216A STARVET needles**, Luer Lock 100 x 20



**Agujae desechablee STARVET**, paq. de 100 unds  
**STARVET disposable needles**, box of 100 pcs

**AG-283** 38 x 2,1

**AG-284** 60 x 2,1

**AG-285** 80 x 2,1

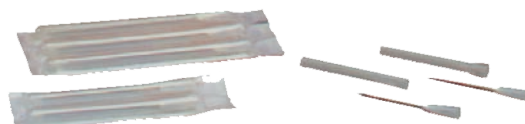

# Agujas desechables estériles STARVET, paq. de 100 uds

STARVET *disposable sterile needles,*  
*box of 100 pcs*

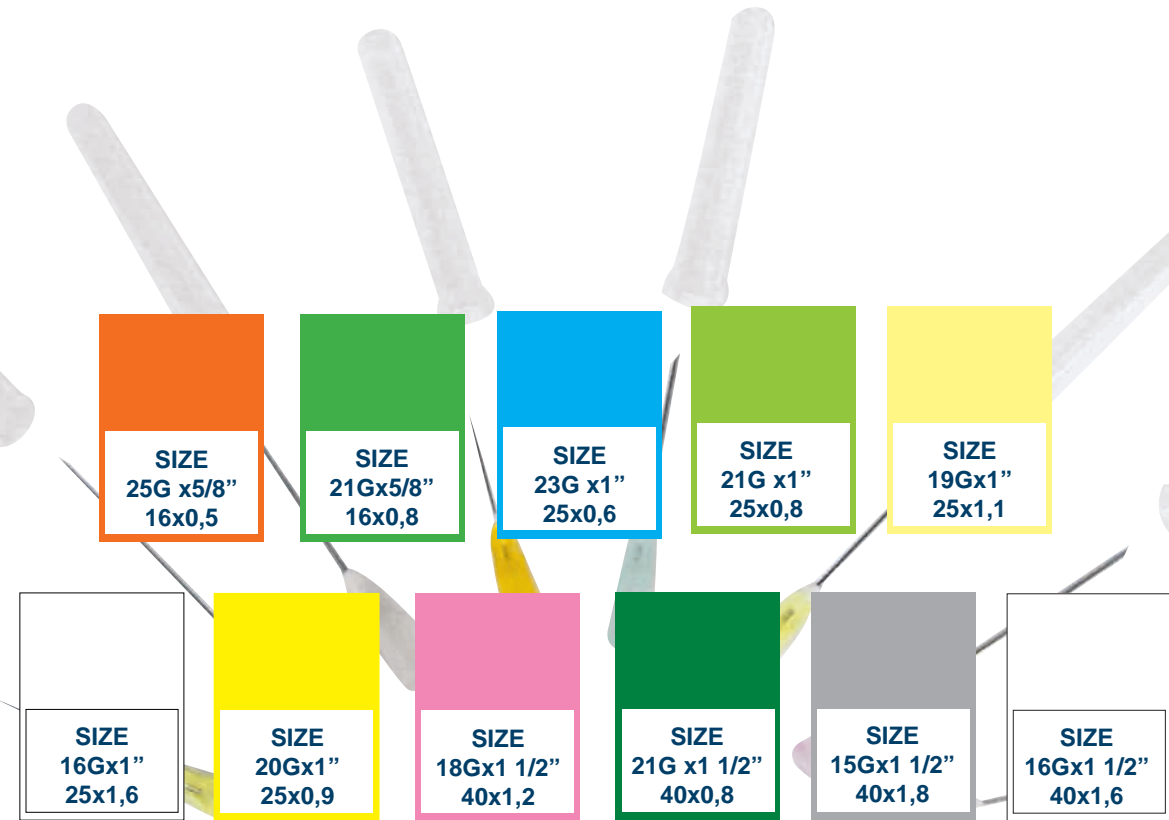

**AG-275** 16 x 0,5

**AG-275A** 16 x 0,8

**AG-276** 25 x 0,6

**AG-277** 25 x 0,8

**AG-278** 25 x 0,9

**AG-279** 25 x 1,1

**AG-279C** 25 x 1,6

**AG-281** 40 x 0,8

**AG-280** 40 x 1,2

**AG-281C** 40 x 1,6

**AG-282** 40 x 1,8





**AG-223A Agujas desechables**  
ARTSANA de 16 x 0,5, paquete de 100 unidades

**AG-223A ARTSANA disposable needles**  
16 x 0.5, box of 100 units



**JG-100F Jeringas desechables STARVET**  
de 1 ml con aguja de 16 x 0,5, paquete de 100 unidades

**JG-100G Jeringas desechables STARVET** de 1 ml sin aguja, paquete de 100 unidades

**JG-100F STARVET disposable syringes**, 1 ml with needle 16 x 0.5, box of 100 units

**JG-100G STARVET disposable syringes**, 1 ml without needle, box of 100 units



**JG-101 Jeringas desechables ARTSANA**  
de 1 ml con aguja de 16 x 0,5, paquete de 100 unidades

**JG-101 ARTSANA disposable syringes** 1 ml with needle 16 x 0.5, box of 100 units



**Jeringas desechables STARVET estériles de 2 cuerpos**  
STARVET sterile **disposable syringes**, 2-component

- JG-100** 2 ml, paquete de 100 unidades
- JG-100A** 5 ml, paquete de 100 unidades
- JG-100B** 10 ml, paquete de 100 unidades
- JG-100C** 20 ml, paquete de 50 unidades

- JG-100** 2 ml, box of 100 units
- JG-100A** 5 ml, box of 100 units
- JG-100B** 10 ml, box of 100 units
- JG-100C** 20 ml, box of 50 units

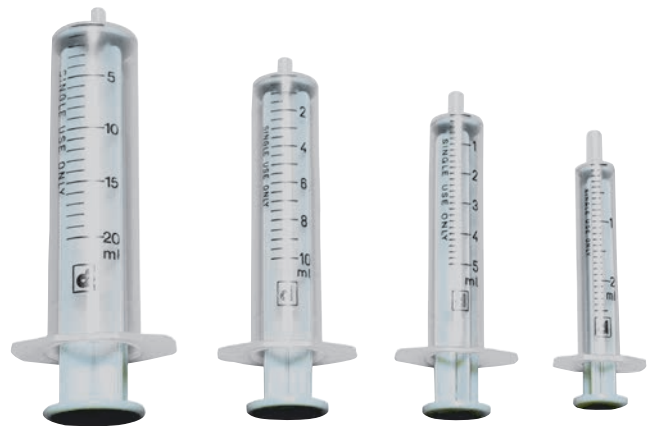



**Jeringas desechables STARVET** estériles de 3 cuerpos  
*STARVET sterile disposable syringes, 3-component*

**JG-100 H** 2 ml, paquete de 100 unidades

**JG-100 J** 5 ml, paquete de 100 unidades

**JG-100 K** 10 ml, paquete de 100 unidades

**JG-100 L** 20 ml, paquete de 50 unidades

*JG-100H 2 ml box of 100 units*

*JG-100J 5 ml box of 100 units*

*JG-100K 10 ml box of 100 units*

*JG-100L 20 ml box of 50 units*



**JG-116A Jeringas desechables** estériles de 50 ml,  
 3 cuerpos, paquete de 25 unidades

*JG-116A Disposable syringes 50 ml, 3-component, box of 25 units*



**JG-117A Jeringa desechable** de 100 ml,  
 3 cuerpos, paquete de 25 unidades

*JG-117A Disposable syringes 100 ml,  
 3-component, box of 25 units*



**Catéter intravenoso 2 vías con aletas**, paquete de 50 unidades *Intravenous injection cannula*, box of 50 pcs

**AG-300A** 14G, 50 x 2,2    **AG-300C** 20G, 33 x 1,1  
**AG-300B** 18G, 45 x 1,3    **AG-300D** 22G, 25 x 0,9



**Equipo de infusión tipo palomilla**, paquete de 50 unidades *Butterfly blood collection set*, box of 50 pcs

**AG-301** 15 x 0,50  
**AG-302** 20 x 0,65



**AG-306 Equipo de infusión** (gotero) doble vía, cono Luer

**AG-306** Luer cone two way, *infusion set*



**AG-305 Equipo de infusión** (gotero) doble vía, cono Luer Lock

**AG-305** Luer Lock cone two way, *infusion set*



**AG-307 Equipo de alimentación completo** tipo gotero, con bolsa

**AG-307** Feeding infusion set with bag

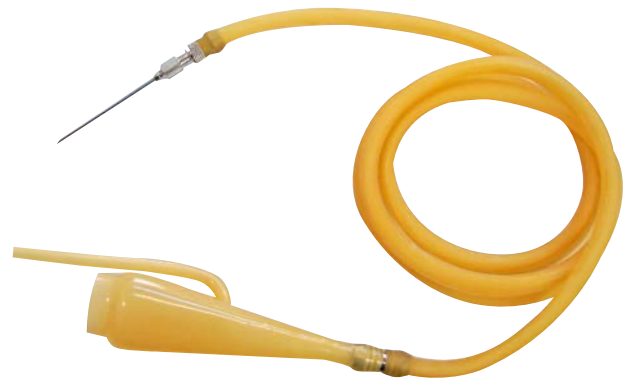

**Equipo de infusión reusable** cono Luer con aguja *Infusion set reusable Luer cone with needle*

**AG-303** 50 x 20

# Jeringas lisas STARVET

STARVET plain syringes

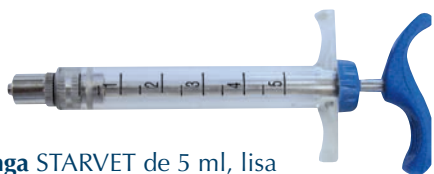

**JG-120 Jeringa** STARVET de 5 ml, lisa

*JG-120 STARVET plain syringe, 5 ml*



**JG-121 Jeringa** STARVET de 10 ml, lisa

*JG-121 STARVET plain syringe, 10 ml*



**JG-122 Jeringa** STARVET de 20 ml, lisa

*JG-122 STARVET plain syringe, 20 ml*



**JG-123 Jeringa** STARVET de 30 ml, lisa

*JG-123 STARVET plain syringe, 30 ml*



**JG-124 Jeringa** STARVET de 50 ml, lisa

*JG-124 STARVET plain syringe, 50 ml*



**JG-129 Jeringa** STARVET de 100 ml, lisa

*JG-129 STARVET plain syringe, 100 ml*

# Jeringas graduables STARVET

STARVET adjustable syringes



**JG-125 Jeringa** STARVET de 10 ml, graduable

*JG-125 STARVET adjustable syringe, 10 ml*



**JG-126 Jeringa** STARVET de 20 ml, graduable

*JG-126 STARVET adjustable syringe, 20 ml*



**JG-127 Jeringa** STARVET de 30 ml, graduable

*JG-127 STARVET adjustable syringe, 30 ml*



**JG-128 Jeringa** STARVET de 50 ml, graduable

*JG-128 STARVET adjustable syringe, 50 ml*



**JG-121A Jeringa** STARVET de 1 m a distancia, de 10 ml  
**JG-122A Jeringa** STARVET de 1 m a distancia, de 20 ml

*JG-121A STARVET syringe at 1 m distance, 10 ml*  
*JG-122A STARVET syringe at 1 m distance, 20 ml*



## JERINGAS VACUNADORAS VACCINATION SYRINGES



### Jeringa vacunadora STARVET con tubo y aguja

*STARVET vaccination syringe with feeding  
tube and needle*

**JG-901** 1 ml (0,05 a/to 1 ml)

**JG-902** 2 ml (0,1 a/to 2 ml)

**JG-905** 5 ml (0,5 a/to 5 ml)



### Jeringa vacunadora STARVET con portavascos

*STARVET vaccination syringe with vial  
holder*

**JG-901A** 1 ml (0,05 a/to 1 ml)

**JG-902A** 2 ml (0,1 a/to 2 ml)

**JG-905A** 5 ml (0,5 a/to 5 ml)

**DE 1, 2 Y 5 ML**  
*1, 2 and 5 ml*



### **Jeringa vacunadora STARVET con botella**

*STARVET vaccination syringe with bottle*

**JG-901B** 1 ml (de 0,05 a/to 1 ml)

**JG-902B** 2 ml (de 0,1 a/to 2 ml)

**JG-905B** 5 ml (de 0,5 a/to 5 ml)

### **Jeringa vacunadora STARVET con contador electrónico digital**

*STARVET vaccination syringe with elec-  
tronic digital counter*

**JG-901D** 1 ml (0,05 a/to 1 ml)

**JG-902C** 2 ml (0,1 a/to 2 ml)

**JG-905C** 5 ml (0,5 a/to 5 ml)



## Alargos / Extension



- JG-985** Alargo de 35cm para jeringa vacunadora STARVET
- JG-986** Alargo de 50cm para jeringa vacunadora STARVET
- JG-987** Alargo-bastón STARVET de 1mt

- JG-985 35cm Extension for STARVET vaccination syringe*
- JG-986 50cm Extension for STARVET vaccination syringe*
- JG-987 STARVET 1m syringe extension*

- JG-927AA** adaptador hembra portafrasco para frasco de 250-500 ml. 33 mm
- JG-927AB** adaptador hembra portafrasco para frasco de 100 ml. 20 mm

- JG-927AA Female bottle-holder adapter for 250-500 ml 33 mm bottle*
- JG-927AB Female bottle-holder adapter for 100 ml 20 mm bottle*



- JG-935A** Racord adaptador STARVET para STERIMATIC
- JG-935B** Tubo de plastico con muelle STERIMATIC para vacunadoras STARVET
- JG-935C** Tapón STERIMATIC para desinfección agujas STARVET, paq. de 5 u
- JG-935D** Kit completo STERIMATIC para jeringa STARVET con 5 tapones mas adaptador

- JG-935A STARVET adapter fitting for STERIMATIC*
- JG-935B STERIMATIC plastic tube with spring for STARVET vaccinators*
- JG-935C STERIMATIC cap for STARVET needle disinfection, pack of 5 units*
- JG-935D STERIMATIC complete kit for STARVET vaccinators with 5 caps plus adapter disinfection, pack of 5 units*



- JG-999G** Protector Fishguard grande de 50mm STARVET
- JG-999F** Protector Fishguard mediano de 25mm STARVET
- JG-999E** Protector Fishguard pequeño de 15mm STARVET

- JG-999G Large 50 mm STARVET Fishguard*
- JG-999F Medium 25 mm STARVET Fishguard*
- JG-999E Small 15 mm STARVET Fishguard*



# ACCESORIOS VACUNADORA

## VACCINATOR ACCESSORIES



**JG-990A Depósito completo** de 3 l, transparente para vacunadoras STARVET

*JG-990A Complete transparent container, 3 l STARVET vaccinators*



**JG-990 Depósito completo** de 3 l para vacunadoras STARVET

*JG-990 Complete container, 3 l STARVET vaccinators*



**Tapones de recambio completos**  
*Complete replacement caps*



**JG-990AA Depósito completo** de 3 l, plano transparente vacunadoras STARVET

**JG-990AB Depósito completo** de 3 l, plano transparente vacunadoras STARVET, sin tubo/entrada de aire

*JG-990AA 3 l complete container, flat transparent STARVET vaccinators*  
*JG-990AB 3 l complete container, flat transparent STARVET vaccinators, without tube/air inlet*

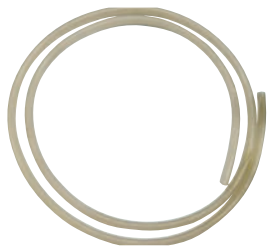

**JG-980 Tubo de silicona** de 1 m

*JG-980 Silicone tube, 1 m*



**JG-990B Juego de trinchas** para depósito STARVET de 3 l

*JG-990B Container holding straps set, 3 l*



**Agujas de aspiración para vacunadora STARVET**  
*Aspiration needle for STARVET vaccinators*

**JG-975** Larga *JG-975 Long*  
**JG-975A** Larga doble *JG-975A Long double*  
**JG-976** Corta *JG-976 Short*

**JG-999A Cinturón porta jeringas** vacunadoras STARVET 1-2ml

**JG-999B Cinturón porta jeringas** vacunadoras STARVET 5ml

*JG-999A STARVET 1-2ml vaccinator syringe holder belt*  
*JG-999B STARVET 5ml vaccinator syringe holder belt*



**Botella con tapón para jeringa STARVET**  
*Complete bottle with cap for STARVET syringe*

**JG-996** 1 l, sin cinturón / without belt  
**JG-995B** 100 ml



**JG-997 Botella completa con cinturón STARVET, 1 l**

*JG-997 Complete STARVET bottle with belt 1 L*



**JG-996A Cinturón portabotella** STARVET, 1 l (sin botella)

*JG-996A STARVET belt bottle carrier 1 l (without bottle)*



## DESPIECE JERINGA VACUNADORA STARVET 5 ML, 2 ML Y 1ML STARVET VACCINATOR SPARE PARTS 5 ML, 2 ML AND 1 ML



5 ml

2 ml

1 ml

N° 1	JG-926	JG-925	JG-924
N° 2	JG-920	JG-915	JG-914
N° 3	JG-931	JG-930	JG-929
N° 4	JG-952	JG-952	JG-952
N° 6	JG-957	JG-957	JG-957
N° 7	JG-956	JG-956	JG-956
N° 8	JG-955	JG-955	JG-955
N° 10	JG-935	JG-935	JG-935
N° 12	JG-936	JG-936	JG-936
N° 13	JG-941	JG-940	JG-939
N° 14	JG-960	JG-960	JG-960

# Vacunadoras STARVET a baterías

5 ml, 2 ml y 1ml

STARVET battery vaccinators

5 ml, 2ml and 1 ml



**Pantalla** con indicador de nivel de batería, contador total y parcial de número de inyecciones

**Display** with battery level indicator, total and partial counter of the number of injections



También con portafrascos

Also with vial holder

- JG-910 1 ml con tubo y aguja
- JG-910A 1 ml con portafrascos
- JG-911 2 ml con tubo y aguja
- JG-911A 2 ml con portafrascos
- JG-912 5 ml con tubo y aguja
- JG-912A 5 ml con portafrascos

- JG-910 1 ml with feeding tube and needle
- JG-910A 1 ml with vial holder
- JG-911 2 ml with feeding tube and needle
- JG-911A 2 ml with vial holder
- JG-912 5 ml with feeding tube and needle
- JG-912A 5 ml with vial holder

Unas 3 horas de trabajo continuo en cada carga de batería

About 3 hours of continuous work on each battery charge

Compatible con todos los recambios y accesorios disponibles para la vacunadora STARVET manual

Compatible with all the spare parts and accessories available for the manual STARVET vaccinator



JG-913 Batería de recambio

JG-913 Replacement battery

JG-994C Spray súper lubricante de grasa al Litio de 200 ml.

JG-994C 200 ml super Lithium grease lubricant spray





**JN-100** Jeringa neumática de 2 ml con tubo de aspiración

*JN-100 Pneumatic syringe with feeding tube (2 ml)*

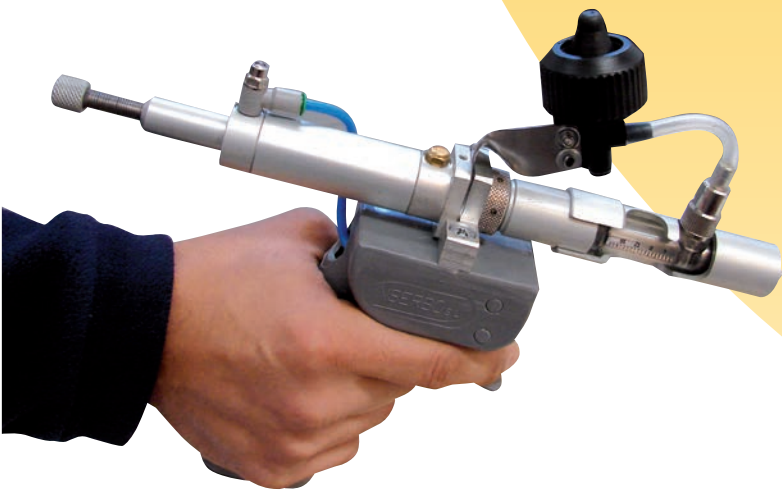

**JN-110** Jeringa neumática de 2 ml con portafrascos

*JN-110 Pneumatic syringe with vial holder (2 ml)*

**JN-150** Jeringa neumática de 5 ml con tubo de aspiración

*JN-150 Pneumatic syringe with feeding tube (5 ml)*



# Jeringas neumáticas

## Pneumatic syringes

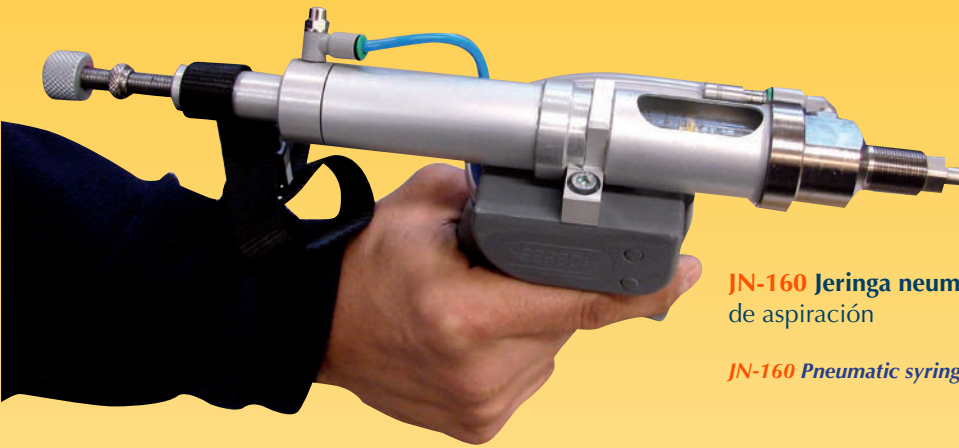

**JN-160** Jeringa neumática de 5/10 ml con tubo de aspiración

*JN-160 Pneumatic syringe with feeding tube (5/10 ml)*



**JN-170** Jeringa neumática de 30 ml con tubo de aspiración

*JN-170 Pneumatic syringe with feeding tube (30 ml)*

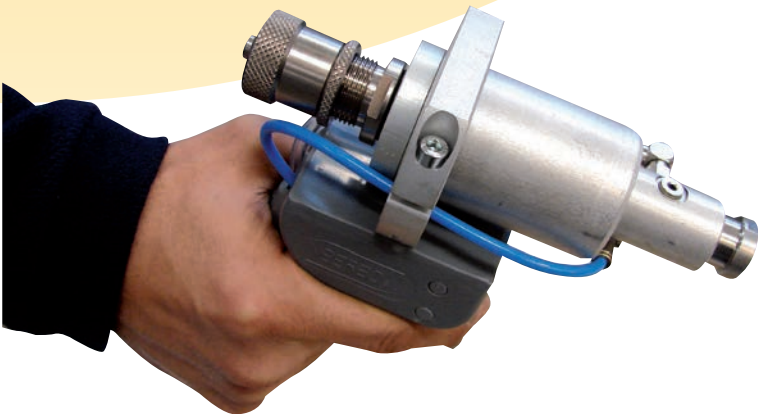

**JN-185** Jeringa neumática "sin aguja" de 0,2 ml  
**JN-190** Jeringa neumática "sin aguja" de 0,1 ml

*JN-185 Pneumatic syringe without needle of 0.2 ml*  
*JN-190 Pneumatic syringe without needle of 0.1 ml*

**JN-140** Jeringa neumática de 2+2 ml con portafascos

**JN-130** Jeringa neumática de 2+2 ml con tubo de aspiración

*JN-140 Pneumatic syringe with vial holder (2+2 ml)*

*JN-130 Pneumatic syringe with feeding tube (2+2 ml)*

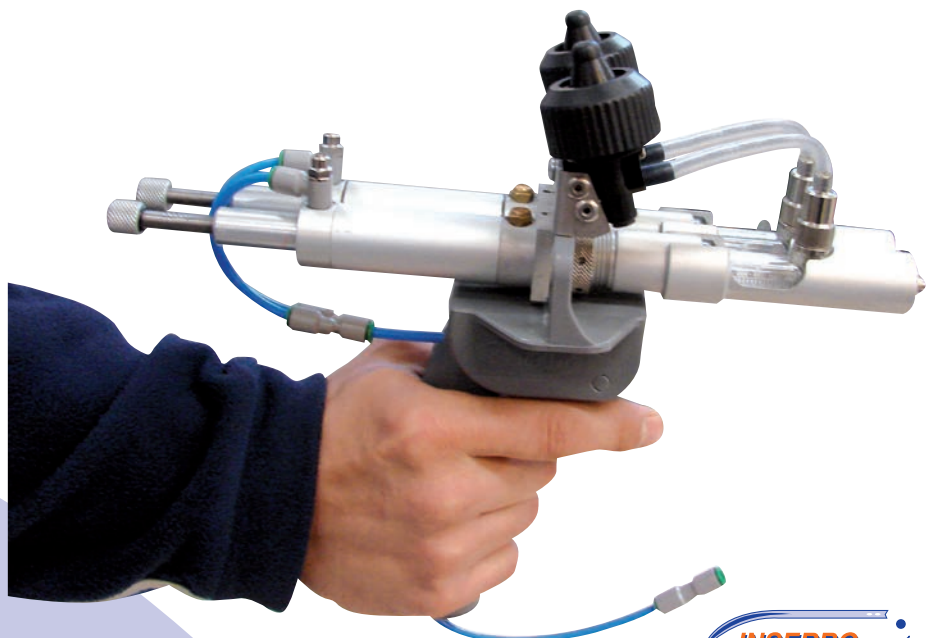



**Alargo flexible / Flexible extension**

**JN-200** 10 cm

**JN-205** 20 cm

**JN-210** 35 cm

**JN-212** 50 cm

**JN-215** 70 cm

**JN-220** 100 cm

**JN-225** 120 cm

**JN-230** 150 cm



**Alargo rígido / Rigid extension**

**JN-235** 10 cm

**JN-240** 20 cm

**JN-245** 40 cm

**JN-250** 70 cm

**JN-255** 100 cm

**JN-260** 120 cm

**JN-265** 150 cm



**JN-295 Multiplicador de presión** para los tanques

*JN-295 Pressure multiplier for tanks*



**JN-310 Portafrascos** para las jeringas neumáticas

*JN-310 Bottle holder for pneumatic syringe*

**JN-285 Carro transporte** con 2 tanques de 10 l para 2 jeringas

*JN-285 Trolley with 2 tanks of 10 l for two syringes*



# Alargos / Carros / Mochilas

## Extensions / Trolleys / Tanks



**JN-290** Carro tratamiento lechones  
con 2 tanques para jeringas neumáticas

*JN-290 Piglets treatment trolley with 2 tanks  
for pneumatic syringes*



**JN-280** Mochila tanque de aire de 10 l

*JN-280 Air tank backpack (10 l)*





**Jeringas vacunadoras SOCOREX con aguja y tubo de goma**  
*SOCOREX vaccination syringes with feeding tube and needle*

- JG-408** 0,3 ml
- JG-409** 0,5 ml
- JG-410** 1 ml
- JG-415** 2 ml
- JG-420** 5 ml
- JG-421** 10 ml

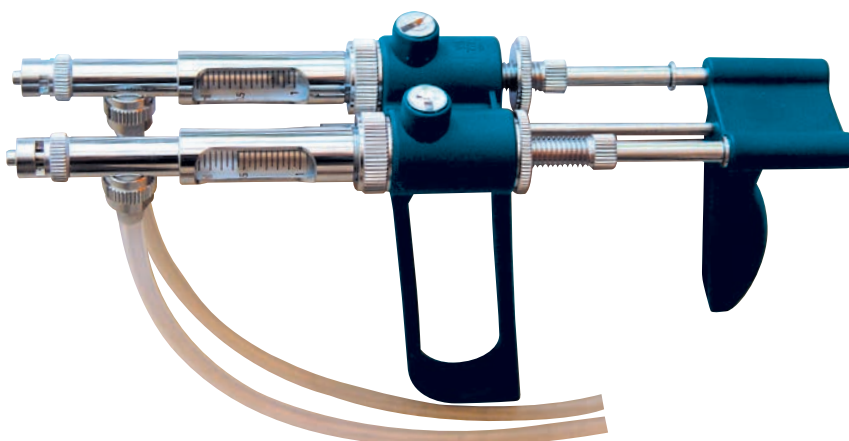
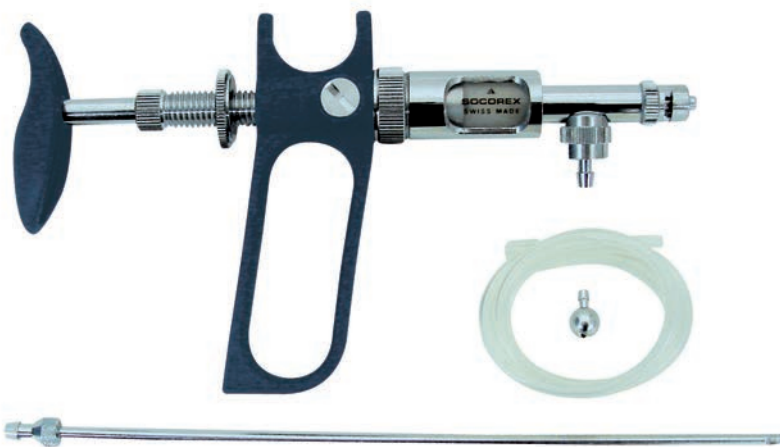

**Jeringas vacunadoras doble SOCOREX**  
con tubo de goma  
*SOCOREX twin syringe with feeding tube*

- JG-422** 0,5 + 0,5 ml
- JG-423** 1+1 ml
- JG-424** 2+2 ml
- JG-424B** 5+5 ml

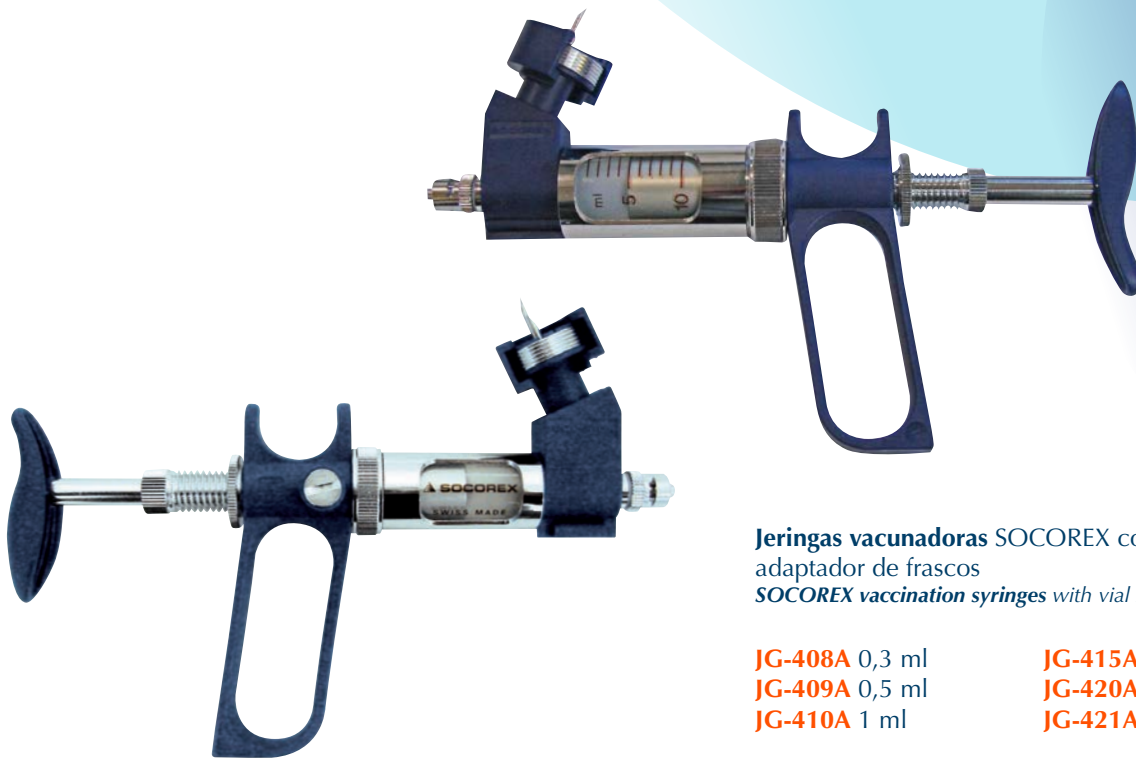

**Jeringas vacunadoras SOCOREX con adaptador de frascos**  
**SOCOREX vaccination syringes with vial holder**

- |                       |                      |
|-----------------------|----------------------|
| <b>JG-408A</b> 0,3 ml | <b>JG-415A</b> 2 ml  |
| <b>JG-409A</b> 0,5 ml | <b>JG-420A</b> 5 ml  |
| <b>JG-410A</b> 1 ml   | <b>JG-421A</b> 10 ml |



**Alargo para jeringa SOCOREX**  
**SOCOREX extension**

- |                      |
|----------------------|
| <b>JG-434</b> 35 cm  |
| <b>JG-434A</b> 20 cm |



**JG-424A Adaptador para jeringa doble SOCOREX para uso de 1 aguja**

**JG-424A** SOCOREX twin syringe adaptor for 1 needle usage



**Agujas de aspiración SOCOREX**  
**SOCOREX aspiration needles**

- |                      |                      |
|----------------------|----------------------|
| <b>JG-438</b> Larga  | <b>JG-438</b> Long   |
| <b>JG-438A</b> Corta | <b>JG-438A</b> Short |



**JG-435 Adaptador SOCOREX para frascos, de 2 a 100 ml**

**JG-435A** Aguja adaptador SOCOREX para frascos, de 1 a 2 ml

**JG-440** Botella SOCOREX, 60 ml

**JG-436** Cono con rosca doble para botella

**JG-435** SOCOREX vial holder from 2 to 100 ml

**JG-435A** SOCOREX vial holder needle

**JG-440** SOCOREX bottle, 60 ml

**JG-436** Bottle cone adaptor, thread



**JG-438B** Aguja aspiración plástico SOCOREX con filtro, paq. 6 uds

**JG-438B** SOCOREX plastic aspiration needle with filter, bag of 6 pcs



**Jeringa vacunadora FIJA SOCOREX con tubo y aguja**  
**SOCOREX fixed vaccination syringe with feeding tube and needle**

- |                       |                       |
|-----------------------|-----------------------|
| <b>JG-424E</b> 0,2ml  | <b>JG-424G</b> 0,5 ml |
| <b>JG-424F</b> 0,3 ml | <b>JG-424H</b> 1 ml   |

**Jeringa vacunadora fija SOCOREX con portafrascos**  
**SOCOREX fixed vaccination syringe with vial holder**

- |                        |                        |
|------------------------|------------------------|
| <b>JG-424EE</b> 0,2ml  | <b>JG-424GG</b> 0,5 ml |
| <b>JG-424FF</b> 0,3 ml | <b>JG-424HH</b> 1 ml   |

**MODELOS DE DOSIS FIJA**  
**FIXED DOSE MODELS**



**JG-429L** Bote de lubricante Premium SOCOREX, 70 ml

**JG-429L** SOCOREX Premium lubricant gel, 70 ml



## DESPIECE JERINGA SYRINGE PART LIST

### JERINGA TUBO Y AGUJA

### FEEDING TUBE SYRINGE

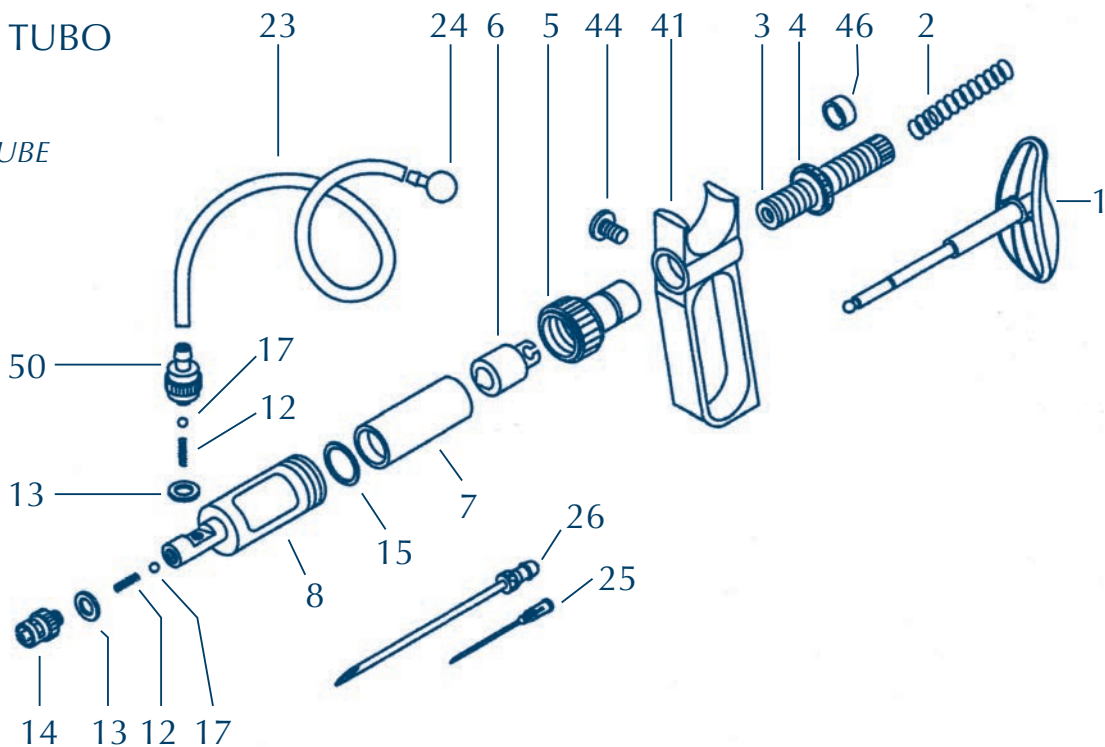

- 1. Varilla de pistón
- 2. Muelle
- 3. Casquillo
- 4. Tuerca
- 5. Tapa
- 6. Pistón
- 7. Cilindro
- 8. Envoltura
- 12. Muelle
- 13. Arandela

- 1. Piston rod
- 2. Spring
- 3. Socket
- 4. Front nut
- 5. Cap
- 6. Piston
- 7. Barrel
- 8. Casing
- 12. Spring
- 13. Washer

- 14. Válvula de cono
- 15. Arandela del cilindro
- 17. Esfera de válvula
- 23. Tubo
- 24. Sumidero (excepto el modelo de 20 ml)
- 25. Cánula de ventilación
- 26. Aguja de alimentación
- 41. Empuñadura
- 44. Tornillo
- 46. Camisa de PTFE

- 14. Nozzle valve
- 15. Washer
- 17. Valve ball
- 23. Tubing
- 24. Sinker
- 25. Vent cannula
- 26. Feed needle
- 41. Two ring handle
- 44. Screw
- 46. Sleeve

- 48. Pieza de mano
- 50. Válvula de entrada
- 51. Tubo de conexión
- 52. Aguja de entrada
- 53. Cuerpo del portavial (2 piezas)
- 54. Anillo, portavial
- 55. Bloqueo, portavial
- 56. Arandela de caucho

- 48. Hand piece
- 50. Intake valve
- 51. Connecting tube
- 52. Intake needle
- 53. Vial holder
- 54. Ring, vial holder
- 55. Lock, vial holder
- 56. Rubber washer

## JERINGA CON PORTAFRASCOS

VIAL HOLDER  
SYRINGE

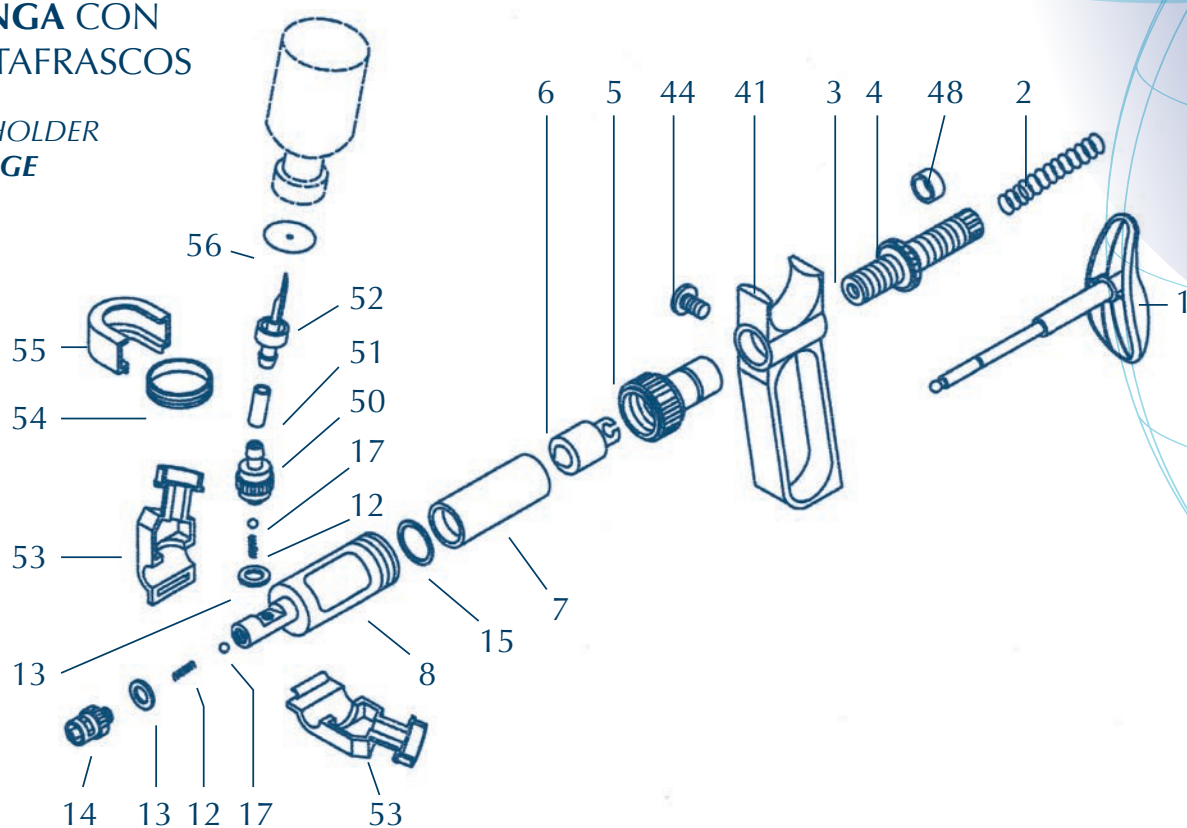

## JERINGA DOBLE

TWIN SYRINGE

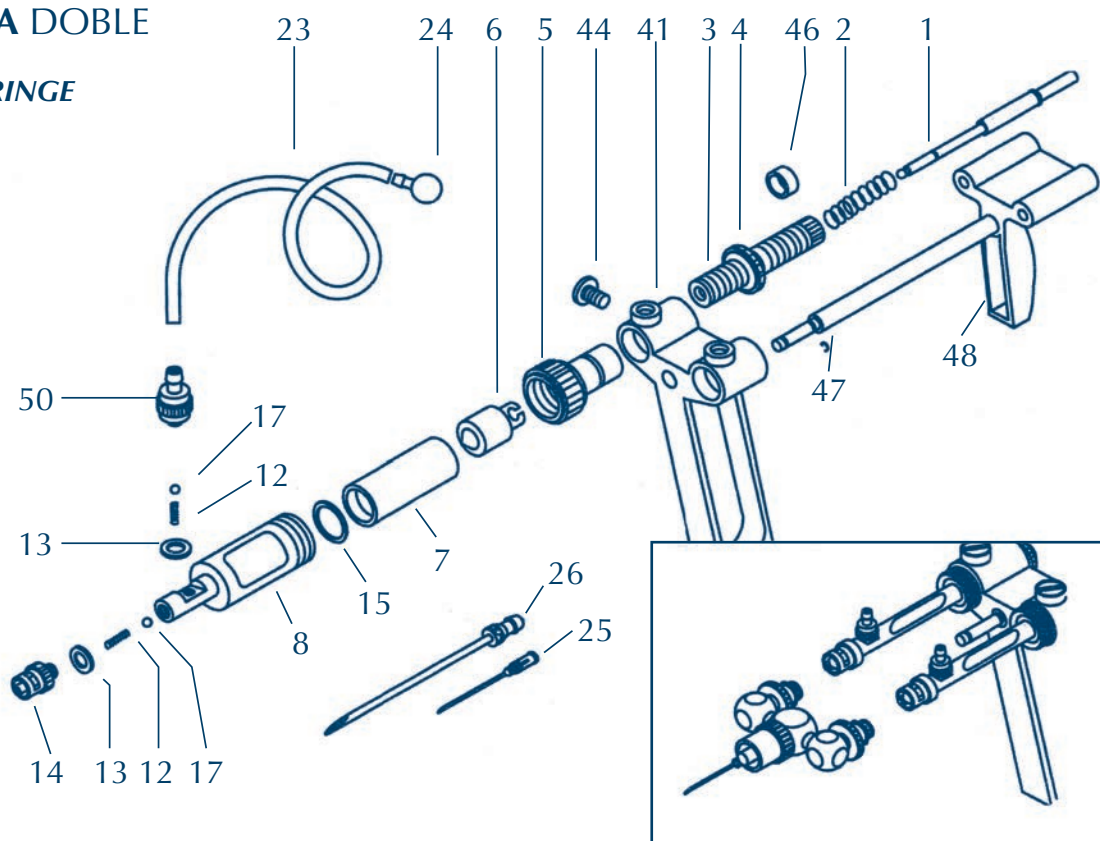

# DESPIECE JERINGA HAUPTNER

## HAUPTNER SYRINGE SPARES

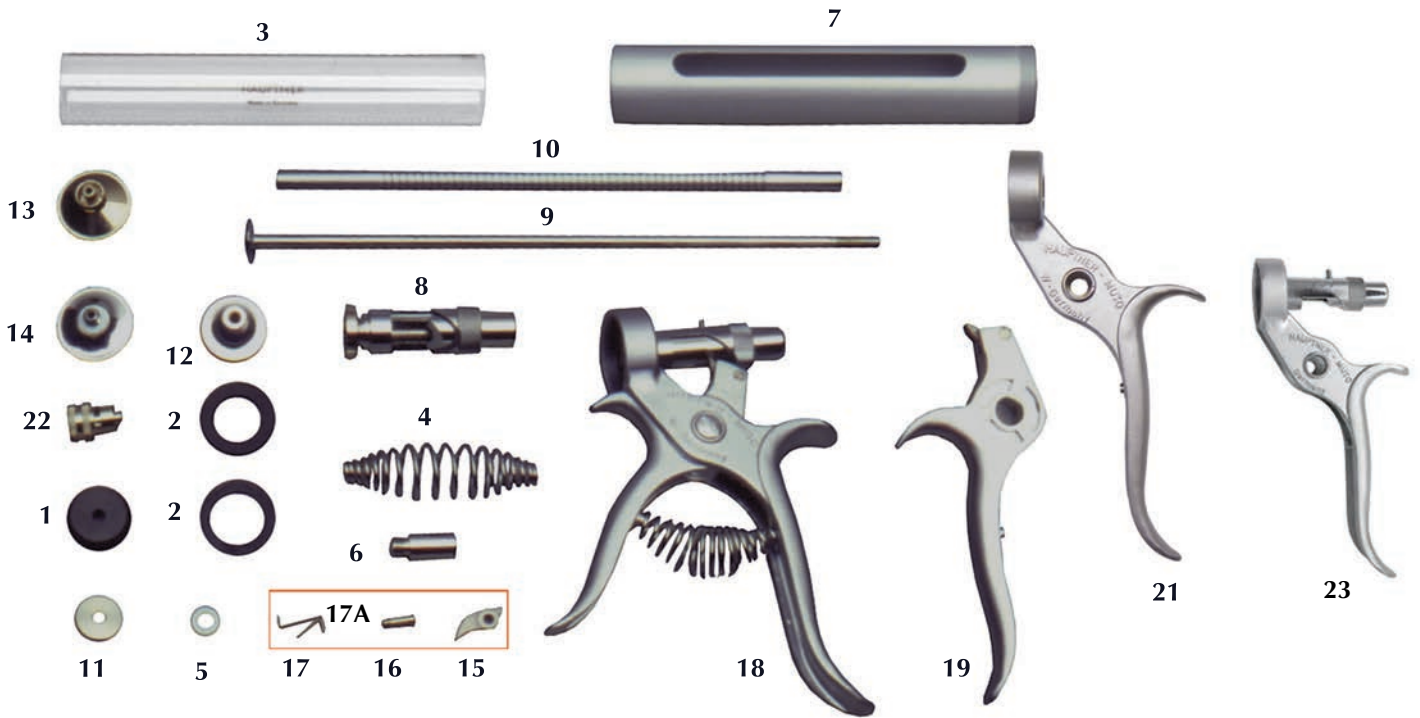

	50 ml	30 ml	25 ml	10 ml
N° 1	JG-195	JG-195	JG-194	JG-193
N° 2	JG-199	JG-199	JG-198	JG-196
N° 3	JG-230	JG-225	JG-220	JG-219
N° 4	JG-235	JG-235	JG-235	JG-235
N° 5	JG-240	JG-240	JG-240	JG-240
N° 6	JG-245	JG-245	JG-245	JG-245
N° 7	JG-250	JG-255	JG-260	JG-261
N° 8	JG-265	JG-265	JG-270	JG-271
N° 9	JG-290	JG-295	JG-300	JG-301
N° 10	JG-305	JG-310	JG-305	JG-311
N° 11	JG-315	JG-315	JG-320	JG-312
N° 12	JG-325	JG-325	JG-325	JG-325
N° 13	JG-330	JG-330	JG-336	----
N° 14	JG-331	JG-331	JG-335	JG-337
N° 15	JG-340	JG-340	JG-340	JG-340
N° 16	JG-345	JG-345	JG-345	JG-345
N° 17	JG-350	JG-350	JG-350	JG-350
N° 17A	JG-339	JG-339	JG-339	JG-339
N° 18	JG-355	JG-355	JG-363	----
N° 19	JG-360	JG-360	JG-360	JG-360
N° 20	JG-361	JG-361	JG-361	JG-361
N° 21	JG-366	JG-366	----	----
N° 22	JG-370	JG-370	JG-370	JG-370
N° 23	JG-365	JG-365	JG-362	----

# Jeringas revólver

## Gun syringes



**JG-175** Jeringa revólver HAAPTNER  
de 10 ml (0,25 a 1 ml)

**JG-175** HAAPTNER *gun syringe*, 10 ml  
(0.25 to 1 ml)

**JG-180** Jeringa revólver HAAPTNER de 25 ml (0,5 a 2,5 ml)

**JG-180** HAAPTNER *gun syringe*, 25 ml (0.5 to 2.5 ml)



**JG-185** Jeringa revólver HAAPTNER de 30 ml  
(de 1 a 5 ml)

**JG-185** HAAPTNER *gun syringe*, 30 ml (1 to 5 ml)



**JG-190** Jeringa revólver HAAPTNER  
de 50 ml (de 1 a 5 ml)

**JG-190** HAAPTNER *gun syringe*, 50 ml (1  
to 5 ml)





**JG-372 Racord HAUPTNER Luer-Lock** para adaptar tubos de silicona

*JG-372 HAUPTNER Luer-Lock **part** to adapt silicone tubes*



**JG-371 Cono HAUPTNER Luer-Lock** para adaptar tubos de silicona

*JG-371 HAUPTNER Luer-Lock **hub** to adapt silicone tubes*



**JG-371A Cono HAUPTNER rosca** para adaptar tubos de silicona

*JG-371A HAUPTNER **thread** to adapt silicone tubes*



**Empaque rosca HAUPTNER**  
*HAUPTNER **needle mount** with thread*

**JG-331** 30 ml y 50 ml  
**JG-335** 25 ml



**JG-381B Cono rosca doble** para alargadera HAUPTNER

*JG-381B HAUPTNER **double thread** for extension syringe*



**JG-370 Rácord HAUPTNER Luer Lock**

*JG-370 HAUPTNER Luer Lock **fitting***

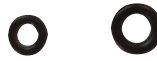

**JG-381A Junta tórica** para alargadera HAUPTNER

*JG-381A HAUPTNER **O-ring** for extension syringe*



**JG-380 Alargador bastón de 90 cm HAUPTNER**

*JG-380 HAUPTNER 90 CM **syringue extension***



**Alargadera para jeringa HAUPTNER**  
*HAUPTNER **syringe extension***

**JG-381** 35 cm  
**JG-382** 25 cm  
**JG-382A** 50 cm



**JG-390 Alargo vacunador para acoplar a jeringas, STARVET-NEEDLE**

*JG-390 STARVET-NEEDLE, **vaccinator extension** to adapt to syringe*



**JG-394 Kit completo Sterimatic para jeringa HAUPTNER** con 5 tapones + adaptador, de 50 ml

*JG-394 HAUPTNER **Sterimatic set** for syringe with 5 caps + adaptor, 50 ml*



**JG-177 Jeringa vacunadora HAUPTNER** con portafrascos

*JG-177 HAUPTNER **vaccination syringe** with vial holder*

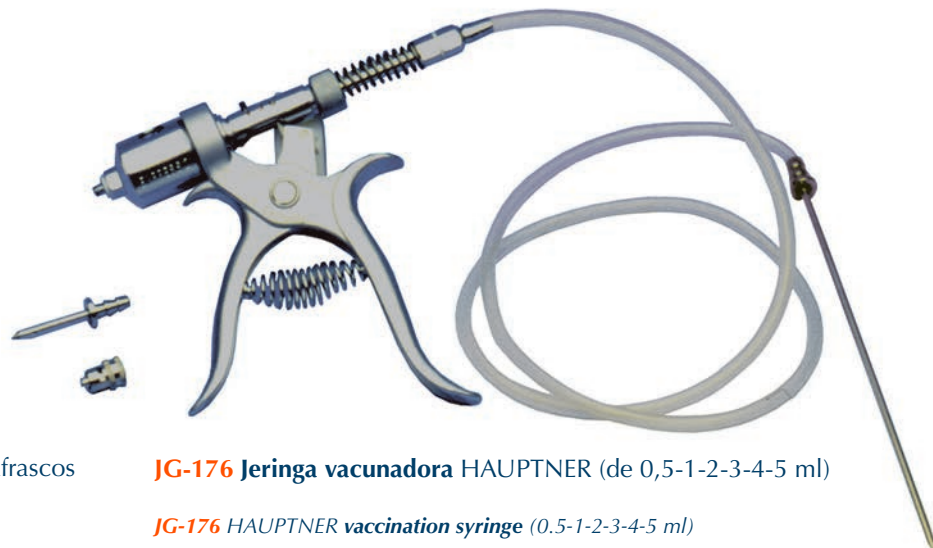

**JG-176 Jeringa vacunadora HAUPTNER** (de 0,5-1-2-3-4-5 ml)

*JG-176 HAUPTNER **vaccination syringe** (0.5-1-2-3-4-5 ml)*

**DESPIECE JERINGA VACUNADORA HAUPTNER**  
**HAUPTNER VACCINATION SPARES**

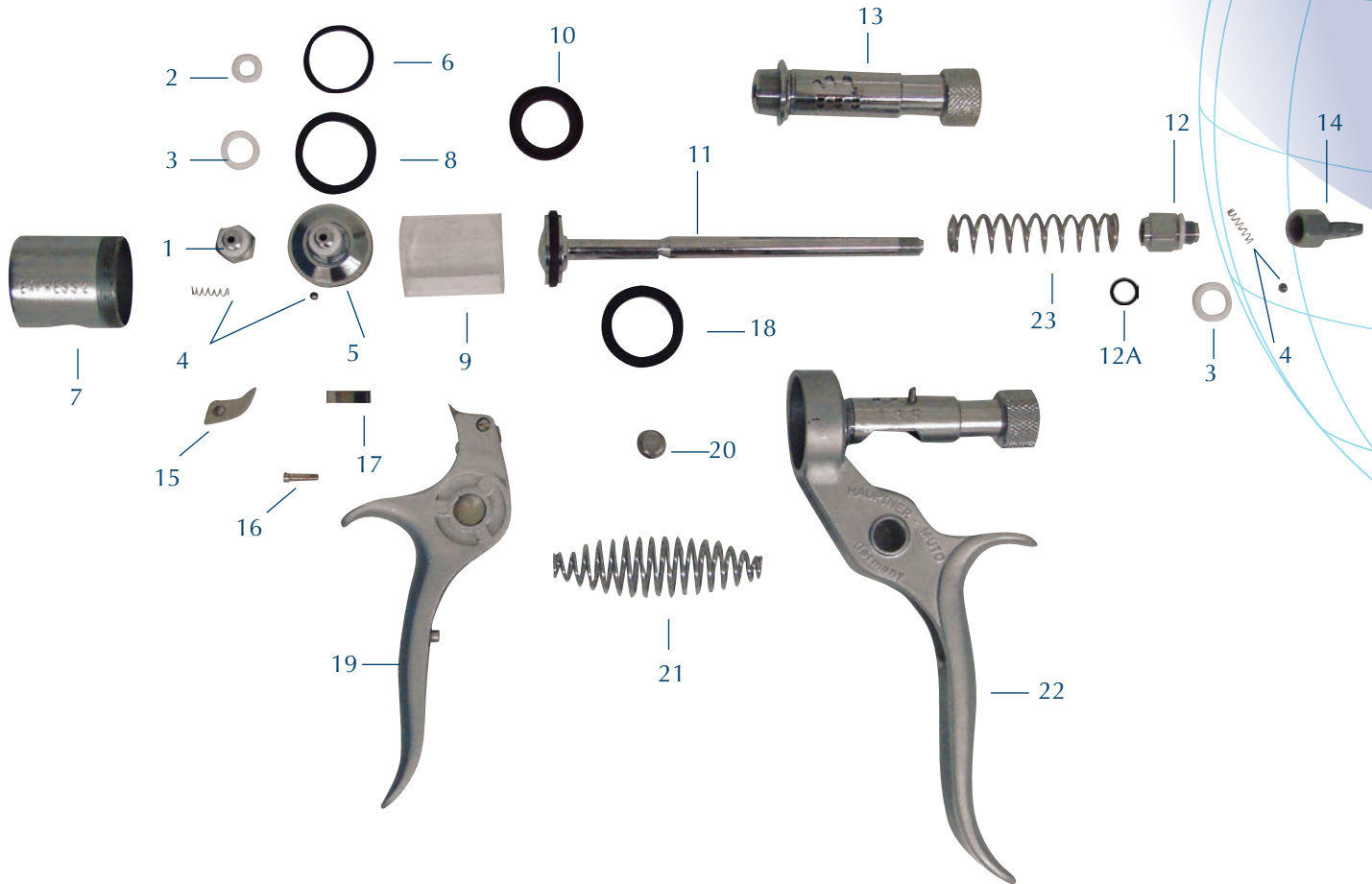

N° 1	JG-386	N° 12A	JG-386J
N° 2	JG-386B	N° 13	JG-385
N° 3	JG-386E	N° 14	JG-386GG
N° 4	JG-375	N° 12 + N° 14	JG-386G
N° 5	JG-386A	N° 15	JG-340
N° 6	JG-386C	N° 16	JG-345
N° 7	JG-386F	N° 17	JG-350
N° 8	JG-386D	N° 18	JG-386DD
N° 8 + N° 18	JG-386H	N° 19	JG-360
N° 9	JG-218	N° 20	JG-245
N° 10	JG-387	N° 21	JG-235
N° 11	JG-384	N° 22	JG-367
N° 12	----	N° 23	JG-386I

N° 2+ N° 3+ N° 6+ N° 8+ N° 10+ N° 12A+ N° 18	JG-387A
--	---------



**JG-803** Jeringa revólver ROUX con alargó, 50 ml

*JG-803 ROUX gun syringe with extension, 50 ml*



**Jeringa revólver ROUX**  
*ROUX gun syringe*

**JG-800** 50 ml

**JG-801** 30 ml

**JG-802** 10 ml



**Jeringa metálica**  
*Metal syringe*

**JG-785** 10 ml

**JG-790** 20 ml

**JG-795** 50 ml

**JG-795A** 100 ml



**JG-150** Jeringa revólver de 50 ml, mango metálico

*JG-150 Gun syringe, 50 ml, metal handle*



**JG-145** Jeringa revólver, 50 ml

*JG-145 Gun syringe, 50 ml*

**GROTEERMAN®**



**JG-900** Jeringa intradérmica GROTEERMAN

**JG-895** Jeringa intradérmica GROTEERMAN con cabezal de 3 salidas

*JG-900* GROTEERMAN *Intradermal syringe*

*JG-895* GROTEERMAN *Intradermal syringe* with 3-outlet head



**JG-900A** Jeringa intradérmica automática GROTEERMAN

**JG-900B** Jeringa intradérmica automática GROTEERMAN con cabezal de 3 salidas

*JG-900A* GROTEERMAN *Intradermal automatic syringe*

*JG-900B* GROTEERMAN *Intradermal automatic syringe* with 3-outlet head



**JG-890** Cabezal de 3 salidas para jeringas GROTEERMAN

*JG-890* 3-exhaust head for GROTEERMAN syringes

# Jeringas revólver y vacunadoras

## Gun syringes / Vaccinators



**Jeringa vacunadora** con aguja y tubo de aspiración  
*Vaccination syringe with feeding tube and needle*

**JG-462** 1 ml  
**JG-460** 2 ml  
**JG-458** 5 ml



**Jeringa vacunadora** con portafrascos  
*Vaccination syringe with vial holder*

**JG-463** 1 ml  
**JG-461** 2 ml  
**JG-459** 5 ml



**JG-465** Jeringa vacunadora de 5 ml, con aguja y tubo (Eco)  
**JG-466** Jeringa vacunadora de 5 ml, con portafrasco (Eco)

**JG-465** Vaccination syringe 5 ml, with feeding tube and needle (Eco)  
**JG-466** Vaccination syringe 5 ml, with vial holder (Eco)

**JG-994A** Spray de silicona, 400ml  
**JG-994B** Spray de vaselina, 400ml

**JG-994A** Silicone spray, 400 ml  
**JG-994B** Vaseline spray, 400 ml



**JG-994C** Spray de grasa al Litio, 200ml

**JG-994C** Lithium grease spray, 200 ml

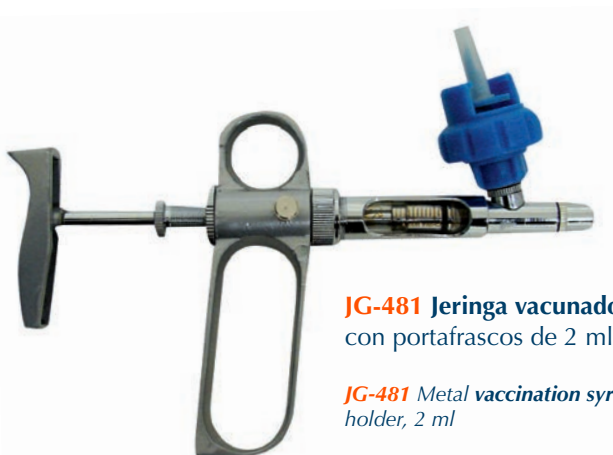

**JG-481** Jeringa vacunadora metálica con portafrascos de 2 ml

**JG-481** Metal vaccination syringe with vial holder, 2 ml

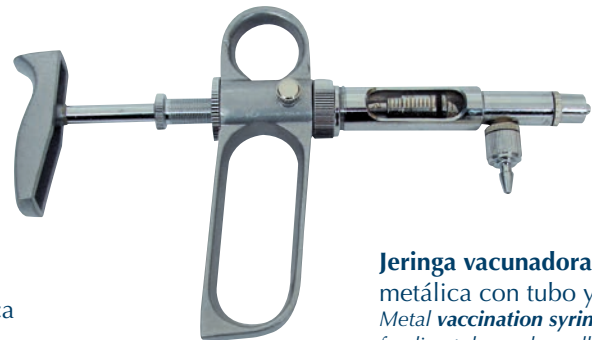

**Jeringa vacunadora** metálica con tubo y aguja  
*Metal vaccination syringe with feeding tube and needle*

**JG-480** 2 ml  
**JG-485** 10 ml

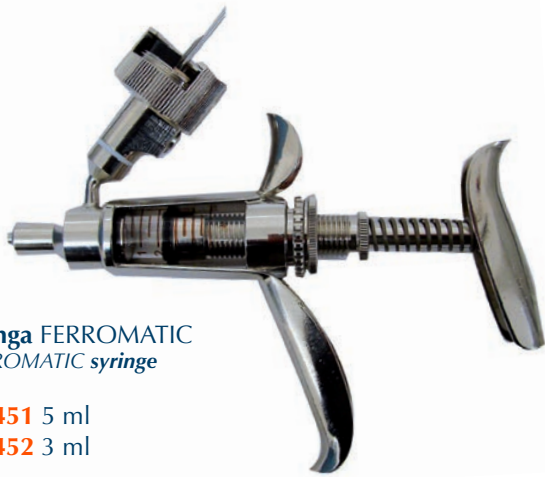

**Jeringa FERROMATIC**  
*FERROMATIC syringe*

**JG-451** 5 ml  
**JG-452** 3 ml



**Jeringa VET-MATIC**  
*VET-MATIC syringe*

**JG-450** 5 ml  
**JG-450A** 10 ml



**Jeringa ECO-MATIC con tubo**  
*ECO-MATIC syringe with feeding tube*

**JG-769** de 1 ml  
**JG-770** de 2 ml  
**JG-771** de 5 ml



**Jeringa ECO-MATIC con set adaptadores universal**  
*ECO-MATIC syringe with universal adaptors*

**JG-773** de 0,3 ml  
**JG-772** de 0,5 ml  
**JG-773A** de 1 ml  
**JG-773B** de 2 ml  
**JG-773C** de 5 ml

**Modelo ECO-GRIS**  
*ECO-GRIS Model*

**JG-763** de 2 ml  
**JG-763A** de 5 ml

**Modelo ECO-GRIS**  
*ECO-GRIS Model*

**JG-763E** de 1 ml  
**JG-763F** de 2 ml  
**JG-763G** de 5 ml



**Jeringa ECO-MATIC con porta-frascos**  
*ECO-MATIC syringe with vial holder*

**JG-765** de 0,3 ml  
**JG-766** de 1 ml  
**JG-767** de 2 ml  
**JG-768** de 5 ml

**Modelo ECO-GRIS**  
*ECO-GRIS Model*

**JG-763B** de 1 ml  
**JG-763C** de 2 ml  
**JG-763D** de 5 ml

**JG-774 Adaptador negro portafrascos**  
reconvertido a tubo

**JG-774 Black bottle holder adapter** converted to tube



**JG-774B Juego de 3 capuchones portafrascos** con salida manguera

**JG-774B Set of 3 bottle holder caps** with hose outlet

# Jeringas revólver y vacunadoras

## Gun syringes / Vaccinators



**Jeringa SERENA** con porta frascos delantero  
SERENA syringe with forward vial holder

**JG-743** 1 ml  
**JG-745** 2 ml



**Jeringa SERENA** con tubo de aspiración  
SERENA syringe with suction tube

**JG-744** 1 ml  
**JG-746** 2 ml  
**JG-748** 5 ml  
**JG-751** 12 ml



**Jeringa SERENA** con porta frascos  
SERENA syringe with vial holder

**JG-745A** 2 ml  
**JG-748A** 5 ml



**JG-754G** Jeringa SERENA de 2+2  
(Con dosificador independiente)  
**JG-754G** SERENA 2+2 SYRINGE  
(WITH INDEPENDENT DISPENSER)



**JG-749** Jeringa SERENA de 5 ml con alargado 40 cm con portafrascos trasero  
**JG-753** Jeringa SERENA de 12 ml con alargado 40 cm con portafrascos trasero

**JG-749** SERENA 5 ml syringe with 40 cm extension with rear bottle holder  
**JG-753** SERENA 12 ml syringe with 40 cm extension with rear bottle holder



**Jeringa SERENA** "montada" con alargado  
SERENA syringe "mounted" with extension

**JG-755** De 5 ml con alargado de 35 cm  
**JG-756** De 5 ml con alargado de 50 cm  
**JG-757** De 2 ml con alargado de 35 cm  
**JG-758** De 2 ml con alargado de 50 cm  
**JG-758A** De 12 ml con alargado de 35 cm  
**JG-758B** De 12 ml con alargado de 50 cm

**JG-755** SERENA 5 ml syringe with 35 cm extension  
**JG-756** SERENA 5 ml syringe with 50 cm extension  
**JG-757** SERENA 2 ml syringe with 35 cm extension  
**JG-758** SERENA 2 ml syringe with 50 cm extension  
**JG-758A** SERENA 12 ml syringe with 35 cm extension  
**JG-758B** SERENA 12 ml syringe with 50 cm extension



**Kit recambio, jeringa SERENA**  
SERENA syringe kit spare parts

**JG-761** 12 ml  
**JG-761A** 5 ml  
**JG-761AA** 2 ml



**Jeringa SERENA** con alargado de 40 cm o de 70 cm  
SERENA syringe with extension (40 cm or 70 cm)

**JG-750** 5 ml (40 cm)  
**JG-752** 12 ml (40 cm)  
**JG-754** 12 ml (70 cm)

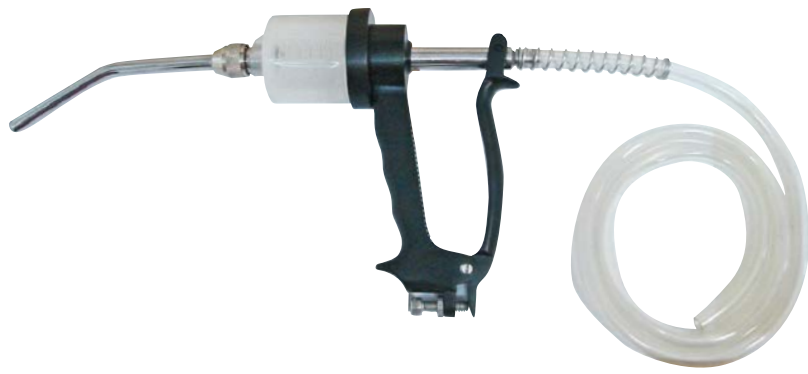

**JG-641** Jeringa dosificadora bucal, de 70 ml

*JG-641 Drenching syringe with cannula (70 ml)*



**JG-640** Jeringa dosificadora bucal de 30 ml

*JG-640 Drenching syringe with cannula (30 ml)*



**JG-637** Jeringa Pour-on STARVET, 10 ml

*JG-637 STARVET Pour-on syringe, 10 ml*



**JG-638** Jeringa dosificadora bucal STARVET, 10 ml

*JG-638 STARVET oral drenching syringe, 10 ml*



**JG-636A** Jeringa vacunadora-dosificadora bucal de 5 ml

*JG-636A 5 ml vaccinator-oral drencher*



**JG-642** Cánula Pour-on para dosificadora bucal

*JG-642 Oral cannula*



**JG-644EE** Adaptador completo con r cord Luer Lock

*JG-644EE Luer Lock complete adaptor*

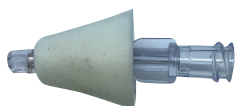

**JG-636** Aplicador vaporizador nasal con cono Luer Lock

*JG-636 Nasal vaporizer applicator with Luer Lock cone*

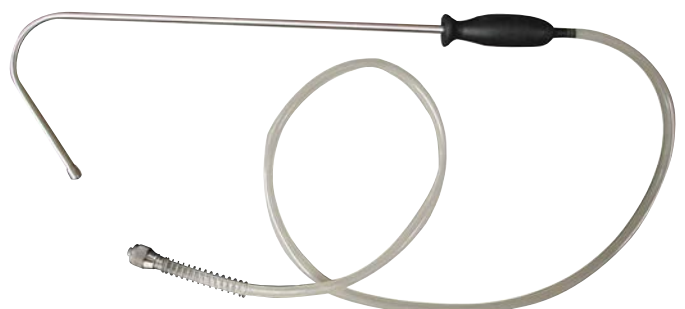

**JG-643** Gancho bucal para dosificadora

*JG-643 Oral hook for drenching syringe*

# Jeringas revólver y bucales

## Gun syringes / Drenchers



**Jeringa dosificadora** bucal manual DRENCHER  
*DRENCHER hand oral drenching syringe*

**JG-676** 70 ml  
**JG-677** 100 ml  
**JG-678** 120 ml  
**JG-679** 150 ml



**JG-740** Jeringa dosificadora bucal  
PISTOLMAN, 250ml

*JG-740 PISTOLMAN drenching syringe,  
250 ml*

**Jeringa dosificadora** bucal azul  
*Blue drenching syringe*



**JG-732** 200 ml  
**JG-734** 300 ml (FLEX)  
**JG-735** 500 ml



**JG-730** 35 ml  
**JG-731** 70 ml



**Cánula bucal** cono Luer Lock universal  
*Oral cannula Luer lock cone*

**JG-118** 12 cm

**JG-119** 17 cm



**JG-673** Adaptador de aguja Luer Lock

*JG-673 Needle adaptor Luer Lock*



**Jeringa dosificadora** bucal automática  
*Automatic drenching syringe with cannula*

**JG-670** 30 ml, sin mochila

**JG-675** 60 ml, sin mochila

*JG-670 30 ml, without container*

*JG-675 60 ml, without container*



**JG-488** Jeringa PHILIPS de 15ml

*JG-488 15ml PHILIPS syringe*



**Dosificador bucal DRENCHMATIC**

*DRENCHMATIC drenching syringe with cannula*

**JG-669** 30 ml

**JG-669AA** 23 ml



**Jeringa PISTOLMATIC**  
*PISTOLMATIC syringe*

**JG-710** 20 ml

**JG-715** 50 ml

**JG-680** Jeringa dosificadora bucal manual, 300 ml

*JG-680 Hand drenching syringe with cannula, 300 ml*



# Jeringas revólver y bucales

## Gun syringes / Drenchers



**JG-650 Depósito** para dosificador bucal completo, 3 l

*JG-650 Complete container for drenching syringe (3 l)*



**JG-649 Depósito** transparente para dosificador bucal completo, 3 l

*JG-649 Complete transparent container for oral drencher, 3 l*



**JG-648 Depósito completo** de 3 l, plano transparente para dosificador bucal

*JG-648 Complete transparent container, flat for oral drencher, 3 l*



**Tapones de recambio completos**  
Complete replacement caps

**JG-991 Para depósito JG-990 y JG-990A**

**JG-991A Para depósito JG-990AA**

**JG-991B Para depósito JG-990AB sin tubo/entrada de aire**

*JG-991 For container JG-990 and JG-990A*

*JG-991A For container JG-990AA*

*JG-991B For container JG-990AB without tube/air inlet*

**JG-651 Para depósito JG-649 y JG-650**

**JG-648A Para depósito JG-648**

*JG-651 For container JG-649 and JG-650*

*JG-648A For container JG-648*



**JG-990AA Depósito completo** de 3 l, plano transparente vacunadoras STARVET

**JG-990AB Depósito completo** de 3 l, plano transparente vacunadoras STARVET, sin tubo/entrada de aire

*JG-990AA 3 l complete container, flat transparent STARVET vaccinators*

*JG-990AB 3 l complete container, flat transparent STARVET vaccinators, without tube/air inlet*



**JG-990A Depósito completo** de 3 l, transparente para vacunadoras STARVET

*JG-990A Complete transparent container, 3 l STARVET vaccinators*



**JG-990 Depósito completo** de 3 l para vacunadoras STARVET

*JG-990 Complete container, 3 l STARVET vaccinators*



**JG-997 Botella completa** con cinturón STARVET, 1 l

*JG-997 Complete STARVET bottle with belt, 1 l*



**JG-172H** Jeringa de tuberculina tipo revólver  
**JG-172F** Cristal para jeringa de tuberculina tipo revólver

*JG-172H Syringe for tuberculin injection, gun form*  
*JG-172F Glass for tuberculin syringe, gun form*

**JG-174** Jeringa de tuberculina HAUPTNER 5ml (de 0,1 a 0,4 ml)  
**JG-174A** Cilindro para jeringa de tuberculina HAUPTNER de 5 ml

*JG-174 HAUPTNER syringe for tuberculin 5 ml (0,1 to 0,4 ml)*  
*JG-174A HAUPTNER cylinder for tuberculin syringe (5 ml)*



**AG-220** Aguja de tuberculina HAUPTNER tipo bayoneta, caja de 12 uds

**AG-221** Aguja de tuberculina HAUPTNER cono Luer Lock, caja de 12 uds

*AG-220 HAUPTNER tuberculin needles, bayonet-type cone, box of 12 pcs*

*AG-221 HAUPTNER tuberculin needles, Luer Lock-type cone, box of 12 pcs*



**AG-218** Aguja de tuberculina STARVET cono Luer Lock, caja de 12 uds

*AG-218 STARVET Luer Lock tuberculin needles, box of 12 pcs*



**JG-173** Jeringa de tuberculina HAUPTNER con cono tipo bayoneta

**JG-217** Cristal para jeringa de tuberculina HAUPTNER

*JG-173 HAUPTNER syringe for tuberculin injection, bayonet-type cone*  
*JG-217 HAUPTNER glass for tuberculin syringe*

# GROTEERMAN®

Jeringa de inoculación intradérmica de la Tuberculina en la prueba IDTB en ganado bovino  
Para la inyección intradérmica de dosificación de 0,1ml.  
Testada por VISAVET (Centro de Vigilancia Sanitaria Veterinaria)

*Tuberculin intradermal inoculation syringe for tuberculin tests in cattle.  
0.1ml intradermal dosage.  
Tested by VISAVET (Veterinary Sanitary Surveillance Center)*

**INYECTA**

**Sin contacto  
Sin aguja**



**INJECTS**

**without contact  
without needle**



**JG-900** Jeringa intradérmica GROTEERMAN

**JG-900** GROTEERMAN intradermal syringe

- Bovino, ovino, caprino y cunícola
- Cattle, sheep, goats and rabbits



UNIVERSIDAD  
COMPLUTENSE  
MADRID

**Sistema APTO para la IDTB (Intradermotuberculinización)**

*Approved system for tuberculin intradermal inoculation*





**JG-172E** Cutímetro para prueba de tuberculina analógico

*JG-172E Analog calliper for tuberculin test*

**JG-172EH** Cutímetro para tuberculina analógico con muelle para zurdos

*JG-172EH Analog tuberculin calliper with spring for left-handed*



**JG-172EE** Cutímetro para tuberculina analógico con muelle

*JG-172EE Analog calliper with spring for tuberculin*

**JG-172CC** Cutímetro analógico tipo pistola HAUPTNER

*JG-172CC HAUPTNER gun type analog tuberculin calliper*



**JG-172A** Cutímetro con reloj

*JG-172A tuberculin calliper with watch*



**JG-172B** Cutímetro digital tipo pistola HAUPTNER

*JG-172B HAUPTNER gun type digital tuberculin calliper*

# Nebulizadores / Garrochas / Cerbatanas

## Air sprayers / Garrocha vaccinator / Blow pipes



- JG-880** Nebulizador para vacunas TURBAIR de 12 V
- JG-881** Batería para TURBAIR de 12 V
- JG-882** Cargador para baterías TURBAIR de 12 V
- JG-883** Mochila con cable para baterías TURBAIR de 12 V

*JG-880 TURBAIR air-assisted sprayer for vaccines, 12V*  
*JG-881 TURBAIR battery, 12V*  
*JG-882 TURBAIR battery charger, 12V*  
*JG-883 TURBAIR bag with cable for batteries, 12V*



- JG-875** Nebulizador para vacunas TURBAIR a 220 V

*JG-875 TURBAIR air-assisted sprayer for vaccines, 220V*



- JG-690** Vacunador de garrocha con rosca, 26 ml

*JG-690 "Garrocha" vaccinator with screw hub, 26 ml*



- JG-692** Vacunador de garrocha STARVET con cono Luer-Lock, 30 ml

*JG-692 STARVET "Garrocha" vaccinator 30 ml with Luer-Lock hub*



**Aguja de rosca para vacunador de garrocha JG-690**  
*Spare screw hub needle for "Garrocha" vaccinator JG-690*

- JG-699** 20x30
- JG-700** 25x30



**Aguja Luer-Lock para vacunador de garrocha JG-692**  
*Luer-Lock needle for "Garrocha" vaccinator JG-692*

- JG-698** 20x30
- JG-698A** 25x30



- JG-695** Mango para vacunador de garrocha, 3 m

*JG-695 Handle for "garrocha" vaccinator, 3 m*



- IC-505** Cerbatana completa

*IC-505 Complete blowpipe*



# Material de inseminación artificial para conejos

*Artificial insemination products  
for rabbits*







**JG-901C** Jeringa automática con cánula recta para I.A. conejos STARVET, 1 ml

**JG-901C** STARVET automatic syringe with straight cannula for rabbit A.I., 1 ml



**JN-180** Jeringa neumática intradérmica de conejos de 0,1 ml

**JN-180** Intradermal pneumatic syringe for rabbits (0.1 ml)



**IA-889** Jeringa completa con cánula metálica para I.A. conejos, 1 ml

**IA-889** Syringe with cannula for rabbit A.I., 1 ml

# GROTEERMAN®



**JG-900** Jeringa intradérmica GROTEERMAN  
**JG-895** Jeringa intradérmica GROTEERMAN con cabezal de 3 salidas

**JG-900** GROTEERMAN *Intradermal syringe*  
**JG-895** GROTEERMAN *Intradermal syringe* with 3-outlet head



**JG-900A** Jeringa intradérmica automática GROTEERMAN  
**JG-900B** Jeringa intradérmica automática GROTEERMAN con cabezal de 3 salidas

**JG-900A** GROTEERMAN *Intradermal automatic syringe*  
**JG-900B** GROTEERMAN *Intradermal automatic syringe* with 3-outlet head



**JG-890** Cabezal de 3 salidas para jeringas GROTEERMAN

**JG-890** 3-exhaust head for GROTEERMAN syringes

**DESPIECE JERINGA GROTEERMAN**  
**GROTEERMAN SYRINGE SPARES**

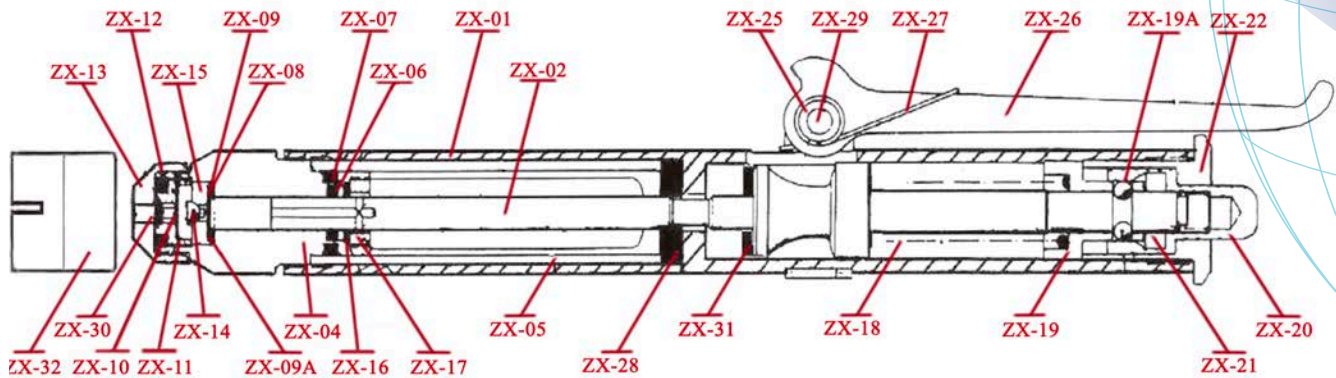

- |                |                             |                |                                   |
|----------------|-----------------------------|----------------|-----------------------------------|
| ZX-01.- .....  | CUERPO DESCUBIERTO          | ZX-17.- .....  | TUERCA DE CARA DE SOPORTE         |
| ZX-02.- .....  | CONJUNTO PISTÓN             | ZX-18.- .....  | MUELLE PRINCIPAL                  |
| ZX-04.- .....  | CABEZA EYECCIÓN DESCUBIERTA | ZX-19.- .....  | CAJA DE BOLAS                     |
| ZX-05.- .....  | TUBO DE DEPÓSITO            | ZX-19A.- ..... | BOLAS                             |
| ZX-06.- .....  | JUNTA TÓRICA R3 PISTÓN      | ZX-20.- .....  | BOTÓN DE SUELTA                   |
| ZX-07.- .....  | JUNTA TÓRICA R7 (Dep. Inf.) | ZX-21.- .....  | MUELLE DEL BOTÓN                  |
| ZX-08.- .....  | ARANDELA TEFLÓN             | ZX-22.- .....  | TUERCA DE LA CABEZA               |
| ZX-09.- .....  | FILTRO GORDO                | ZX-25.- .....  | CASQUILLO DE PALANCA              |
| ZX-09A.- ..... | FILTRO FINO                 | ZX-26.- .....  | PALANCA ARMAMENTO                 |
| ZX-10.- .....  | MUELLE DE VÁLVULA           | ZX-27.- .....  | MUELLE ALFILER DE PALANCA         |
| ZX-11.- .....  | ASIENTO DE PASTILLA         | ZX-28.- .....  | JUNTA TÓRICA SUPERIOR DE DEPÓSITO |
| ZX-12.- .....  | JUNTA TÓRICA DE CABEZA      | ZX-29.- .....  | EJE DE PALANCA                    |
| ZX-13.- .....  | TUERCA DE PASTILLA          | ZX-30.- .....  | INYECTOR RUBÍ                     |
| ZX-14.- .....  | VÁLVULA                     | ZX-31.- .....  | JUNTA DENTRO DEL COLLARÍN         |
| ZX-15.- .....  | ASIENTO DE VÁLVULA          | ZX-32.- .....  | CONTERA                           |
| ZX-16.- .....  | CARA DE SOPORTE             |                |                                   |

- ZX-01.- ..... *OUTSIDE BODY*  
 ZX-02.- ..... *PISTON*  
 ZX-04.- ..... *EJECTION HEAD*  
 ZX-05.- ..... *DEPOSIT BARREL*  
 ZX-06.- ..... *R3 WASHER*  
 ZX-07.- ..... *R7 WASHER*  
 ZX-08.- ..... *TEFLON WASHER*  
 ZX-09.- ..... *BIG FILTER*  
 ZX-09A.- ..... *SMALL WASHER*  
 ZX-10.- ..... *VALVE SPRING*  
 ZX-11.- ..... *SEAT*  
 ZX-12.- ..... *HEAD TORIC WASHER*  
 ZX-13.- ..... *NUT*  
 ZX-14.- ..... *VALVE*  
 ZX-15.- ..... *VALVE SEAT*  
 ZX-16.- ..... *SUPPORT PART*

- ZX-17.- ..... *SUPPORT NUT*  
 ZX-18.- ..... *MAIN SPRING*  
 ZX-19.- ..... *BALL BOX*  
 ZX-19A.- ..... *BALLS*  
 ZX-20.- ..... *BUTTON*  
 ZX-21.- ..... *BUTTON SPRING*  
 ZX-22.- ..... *HEAD NUT*  
 ZX-25.- ..... *LEVER SLEEVE*  
 ZX-26.- ..... *LEVER*  
 ZX-27.- ..... *LEVER SPRING*  
 ZX-28.- ..... *UPPER TORIC WASHER*  
 ZX-29.- ..... *LEVER AXIS*  
 ZX-30.- ..... *RUBY INJECTOR*  
 ZX-31.- ..... *INSIDE WASHER*  
 ZX-32.- ..... *TIP*



**IB-725** Báscula digital hasta 20 kg para pesar animales

**IB-725** Digital scale (up to 20 kg) for animals



**IA-873A** Diluyente para semen conejos vial de 250 ml (500 dosis)

**IA-873A** Rabbit semen extender, 250 ml (500 doses flask)



**IA-864** Colector de semen conejos de 5 ml

**IA-864** Rabbit semen tubes 5 ml



**IA-855** Vagina artificial conejos

**IA-855** Rabbit artificial vagina



**IA-853** Vagina artificial de silicona para conejos

**IA-853** Silicon artificial vagina for rabbits



**IA-860** Cámara recolectora conejos

**IA-860** Rabbits collector sheath



**IA-875** Colector diluido de 50 ml, paq. de 25 uds

**IA-875** Diluted substance tube, 50 ml  
Box of 25 units

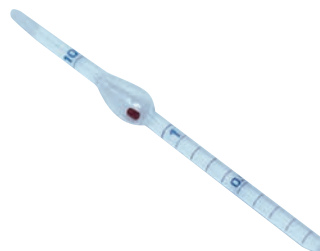

**IA-915** Pipeta para contaje de semen conejo

**IA-915** Pipette for semen measuring



**IA-880** Envoltorio térmico

**IA-880** Thermic cover

# Inseminación conejos

## Rabbit insemination



**IA-887** Cánulas curvadas de vidrio

*IA-887 Glass curved cannulas*

**IA-884** Cánulas curvadas desechables, paquete de 100 unidades

**IA-885** Cánulas curvadas desechables INSERBO (Mdo-A), paquete de 100 unidades

*IA-884 Disposable curved cannulas, box of 100 units*

*IA-885 INSERBO disposable curved cannulas (A model), box of 100 units*

**IA-888** Cánulas rectas desechables, paquete de 100 unidades

**IA-888A** Cánulas rectas desechables INSERBO, paquete de 100 unds

*IA-888 Disposable straight cannulas, box of 100 units*

*IA-888A INSERBO disposable straight cannulas, box of 100 units*

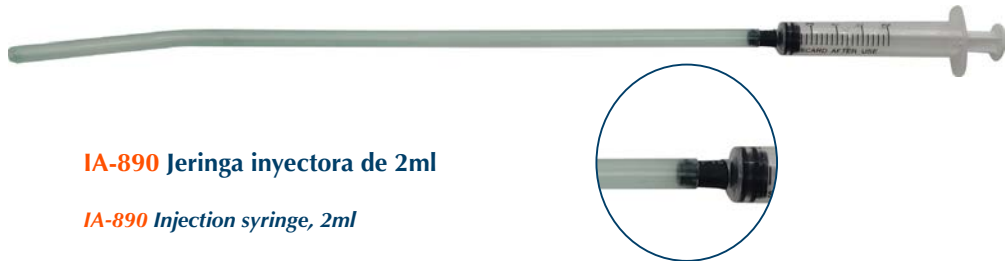

**IA-890** Jeringa inyectora de 2ml

*IA-890 Injection syringe, 2ml*

**JG-901C** Jeringa automática STARVET con cánula recta para I.A. conejos, 1 ml

*JG-901C STARVET automatic syringe with straight cannula for rabbit A.I., 1 ml*



**JG-998A** Depósito completo para vacunadora STARVET, de 50 ml

*JG-998A Complete container for STARVET vaccinator, 50 ml*



**IA-850** Máquina para llenado de dosis seminales de conejos

*IA-850 Rabbit sperm dosage filling machine*





# Ecógrafo portátil INSERBO FUTURE-1



4 modos de pantalla  
4 screen modes

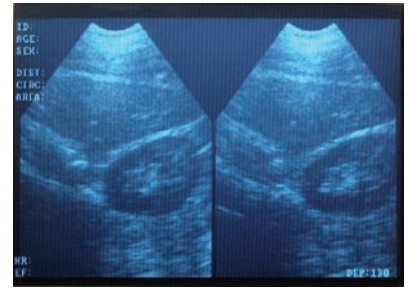

Modo B+B  
B+B Mode

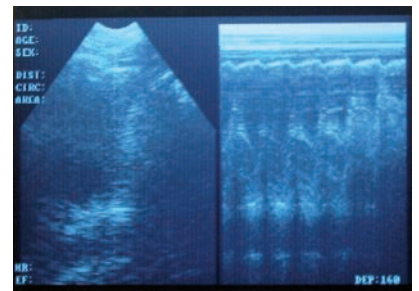

Modo B+M  
B+M Mode

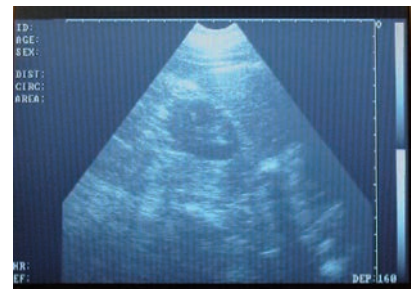

Modo B  
B Mode

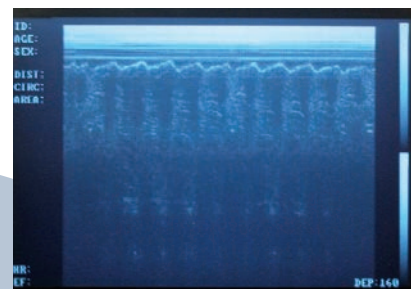

Modo M  
M Mode

## Un gigante en miniatura

*INSERBO portable scanner  
A giant in miniature*

**DG-500** Ecógrafo portátil FUTURE-1

*DG-500 Portable scanner FUTURE-1*

14,5 cm x 11,5 cm x 4 cm y 595 g  
(medidas y peso. ¡CON BATERÍA INCLUIDA!)  
(Size and weight WITH BATTERIES INCLUDED!)

Gigante por prestaciones, miniatura por precio y tamaño  
*Giant in performance, miniature in price and size*

# Ecógrafos Scanners



**DG-655** Correa de sujeción para ecógrafo FUTURE-1

*DG-655 FUTURE-1 holding straps*



**DG-660** Kit para muñeca ecógrafo FUTURE-1

*DG-660 FUTURE-1 wrist kit*



**DG-545** Vídeo gafas para ecógrafo FUTURE-1

*DG-545 Video glasses for FUTURE-1 scanner*



**DG-570** Sonda multifrecuencial FUTURE-1

*DG-570 FUTURE-1 multifrequency probe*



**DG-550** Batería de recambio FUTURE-1

*DG-550 FUTURE-1 spare battery*



**DG-555** Cargador para automóvil FUTURE-1, 12 V

*DG-555 Car charger for FUTURE-1 scanner, 12v*



**DG-560** Cargador FUTURE-1, 110/220 V

*DG-560 Charger for FUTURE-1 scanner, 110/220 v*

# Ecógrafo portátil INSERBO **FUTURE WIFI**

**DG-750** Sonda para ecografía FUTURE-WIFI completa con maleta

**DG-750** FUTURE-WIFI *ultrasound probe* complete with case



- Superficie ergonómica y antideslizante
- Mas de 3 horas de batería
- Parada de imagen en la soinda
- Funciona con una APP
- Waterproof

- *Ergonomic and anti-slip*
- *More than 3 hours of battery*
- *Image freeze in sound*
- *Works with an APP*
- *Waterproof*



Kit de muñeca o Correa de sujeción

*Wrist kit or Holding straps*



**DG-760** Tablet con pantalla de 7" waterproof IP-68 y antigolpes

**DG-760** *Tablet with 7" screen waterproof and shockproof*

**Tablet a prueba de polvo, agua y golpes**  
*Dust, water and shock proof tablet*



# Ecógrafo portátil INSERBO FUTURE-2



**DG-475** Ecógrafo portátil FUTURE-2

*DG-475* Portable scanner FUTURE-2

## DIMENSIONES DIMENSIONS



**DG-481** Sonda de recambio Waterproof para FUTURE-2

*DG-481* Waterproof spare **probe** for FUTURE-2



**DG-480** Batería de recambio para FUTURE-2

*DG-480* Spare **battery** for FUTURE-2



## STARVET-SONIC

**DG-200** Gel de ecógrafo STARVET-SONIC, 5.000 ml

*DG-200 STARVET-SONIC scanner gel, 5,000 ml*



**DG-700** Ecógrafo portátil con batería y sonda lineal transrectal

*DG-700 Portable scanner with battery and transrectal liner probe*



**IP-117** Rollo de tubo plástico, para sondas de 400 m

*IP-117 Plastic tube for probes, 400 m*



**DG-130B** Detector de gestación Preg-Tone

*DG-130B Preg-Tone gestation detector*



**DG-220** Toallitas desinfectantes para instrumentos y aparatos veterinarios, de 150 uds

*DG-220 Disinfectant towels for veterinary instruments, 150 units*



**DG-210** Desinfectante para ecógrafos y sondas

*DG-210 disinfectant for scanners and probes*

**DG-123** Medidor de grasa LEAN METER

*DG-123 LEAN METER fat meter*



**DG-122** Medidor de grasa con lector de chips INSERBO

*DG-122 INSERBO fat meter with chip reader*



**IC-290** Pistola para extracción de grasa

*IC-290 Fat extraction pistol*

# Detectores / Triquinoscopios / Digestores

## Detectors / Trichinoscopes / Digestors



**IT-149A Triquinoscopio** de pantalla (modelo homologado)

*IT-149A Screen trichinoscope (officially approved model)*



**IT-149 Triquinoscopio** de pantalla

*IT-149 Trichinoscope with screen*

**IT-159 Ácido Clorhídrico** (HCL) 25% 1L

*IT-159 Hydrochloric Acid (HCL) 25% 1Lt*

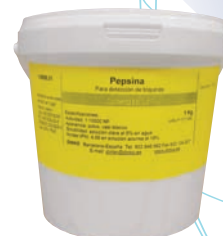

**Pepsina / Pepsin**

**IT-159A** De 1 kg  
**IT-159B** Paquete de 50 x 10 g  
**IT-159BB** Paquete de 10 x 10 g  
**IT-159BC** Sobre de 5 g

*IT-159A 1 kg  
 IT-159B Package of 50x10 g  
 IT-159BB Package of 10x10 g  
 IT-159BC Envelope of 5 g*



**IT-150 Compressor para triquina** de 28 casillas HAUPTNER

*IT-150 HAUPTNER compressor for trichina with 28 divisions*



**IT-159D Embudo** decantador de separación de 2 l con llave Teflón

*IT-159D Separatory funnel 2 l with PTFE stop*



**IT-159H Tamiz** Inox 100 mm diámetro malla, 0,180 mm luz

*IT-159H Stainless steel 100 mm sieve, 0.180 mm light*



**IT-156 Digestor** para análisis de carnes completo con bomba y mueble

*IT-156 Digester for meat analysis with pump and holder*



**IT-158 Digestor-Equipo** para detección de triquina

*IT-158 Digester for trichina detection*



Esta cámara de vídeo se adapta al ocular de la gran mayoría de los microscopios sin ser necesario un adaptador opcional.

*Video camera adaptable to the majority of microscopes. No adaptor needed.*



**IA-150** Cámara de vídeo y monitor de 12" para microscopios (b/n)

**IA-152** Cámara de vídeo y monitor de 10" para microscopios (color)

*IA-150 Video camera and monitor of 12" for microscopes (B/W)*

*IA-152 Video camera and monitor of 10" for microscopes (color)*

**Cámara de vídeo para microscopio**  
*Video camera for microscope*

**IA-153** Conexión a ordenador

**IA-153A** Conexión a ordenador, alta resolución

**IA-153B** Conexión a ordenador, alta resolución (7)

*IA-153 Computer connection*

*IA-153A High resolution computer connection*

*IA-153B High resolution computer connection (7)*



**IA-106** Microscopio triocular con luz halógena de 1.500X (contraste de fases)

**Accesorios principales:**

- Set simple polarizador
- Kit de contraste de fases con objetivos planos acromáticos: PH10X, PH20X(S), PH40X(S), PH100X(S OIL)
- Condensador anular de contraste de fases
- Telescopio centrador, filtro verde

*IA-106 Trinocular microscope with halogen light, 1500X (phase contrast kit)*

**Main accessories:**

- Simple polarization set
- Turret phase contrast kit with plan-achromatic objectives: PH10X, PH20X(S), PH40X(S), PH100X(S OIL)
- Turret annular phase contrast condenser
- Centering telescope, green filter

### CARACTERÍSTICAS / CHARACTERISTICS

CABEZAL: cabezal triocular Sidentopf (inclinación de 30°)	VIEWING HEAD: Sidentopf trinocular head (30° inclined)
OCULAR: WF 10X/20WF 15X/15	EYEPIECE: WF 10X/20 WF 15X/15
REVÓLVER: revólver cuádruple	NOSEPIECE: Inward quadruple nosepiece
OBJETIVOS: (Sistema iOS) acromáticos 4X, 10X, 40X, 100X	OBJECTIVES: (iOS system) Achromatic 4X, 10X, 40X, 100X
CARRO/PLATINA: 135 x 153 mm. Platina mecánica rango de movimiento: 80 x 50 mm	STAGE: 135 x 153 mm mechanical stage moving range: 80 x 50 mm
CONDENSADOR: condensador Abbe N.A.1.25	CONDENSER: N.A.1.25 Abbe condenser
AJUSTE: control de ajuste con mandos coaxiales y ajuste de precisión	FOCUSING: coaxial coarse and fine focusing controls
RECOLECTOR: recolector con diafragma de campo	COLLECTOR: Collector with field diaphragm
ILUMINACIÓN: lámpara halógena de 6 V 20 W	ILLUMINATION: 6 V 20 W halogen lamp
FILTRO: azul, amarillo, verde	FILTER: Blue, yellow, green
ENVOLTORIO: caja y envase de poliestireno	PACKING: Styrofoam box and carton

# Microscopios Microscopes



**IA-101** Microscopio monocular de 1.600X con luz halógena

*IA-101 Monocular microscope with halogen light, 1600X*



**IA-102** Microscopio binocular de 1.600X con luz halógena

*IA-102 Binocular microscope with halogen light, 1600X*



**IA-103** Microscopio monocular de 1.600X con luz

*IA-103 Monocular microscope with light, 1600X*



**IA-104** Microscopio binocular de 1.600X con luz halógena

*IA-104 Binocular microscope with halogen light, 1600X*



**IA-105** Microscopio triocular de 1.600X con luz halógena (adaptable a cámara de vídeo)

*IA-105 Trinocular microscope with halogen light, 1600X (adaptable to video camera)*



**IA-151** Cámara con pantalla integrada para microscopios

*IA-151 Video camera with integrated monitor for microscopes*



**IA-110** Estereomicroscopio binocular con zoom XT-203

*IA-110 Binocular **stereomicroscope** with zoom XT-203*



**IA-111** Estereomicroscopio binocular sin zoom XT-202

*IA-111 Binocular **stereomicroscope** without zoom XT-202*



**IA-180** Refractómetro de mano clínico con compensación automática de temperatura

*IA-180 Pocket clinical **refractometer** with automatic temperature compensation*

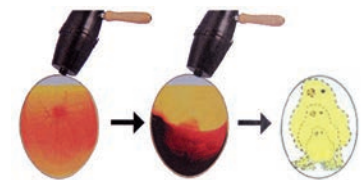

**IA-175** Ovoscopio con mango y bombilla de 60 W

*IA-175 **Ovoscope** (including handle and lamp 60 W)*

# Estereomicroscopios / Estufas / Centrifuga

## Stereomicroscopes / Stoves / Centrifuge



Modelo analógico

**IA-200B Estufas** para desecación, esterilización y de cultivos

**IA-200B** *Drying, sterilizing and culture stoves*

Todos los modelos están también disponibles con circulación forzada de aire, función de doble temperatura, microprocesador digital electrónico de temperatura y tiempo.

- Estufas con regulación para desecación
- Convección natural de aire (IA-200B)
- Convección forzada de aire (IA-200BC)
- Temperatura regulable desde ambiente desde +5 °C hasta 220 °C
- Termómetro lector de temperatura hasta 250 °C
- 2 bandejas interiores en acero inoxidable

*All models available with forced air circulation, double temperature function, time and temperature electronic and digital microprocessor*

- *With regulation*
- *Natural air convection (IA-200B)*
- *Forced air convection (IA-200BC)*
- *Temperatures from +5°C to 220°C*
- *Thermometer to read temperatures up to 250°C*
- *2 interior stainless steel trays*

CÓDIGO CODE	CAPACIDAD l LITRE CAPACITY	MEDIDAS EXTERIORES EXTERIOR MEASURES			MEDIDAS INTERIORES INTERIOR MEASURES			CONSUMO W	PESO WEIGHT
		Alto HIGH	Ancho WIDE	Fondo DEEP	Alto HIGH	Ancho WIDE	Fondo DEEP		
IA-200B	80	66	77	46	48	48	35	1230	49
IA-200BC	72	75,5	52,2	55	49,6	40,2	40,5	1120	49



**IA-200BC Estufa** para desecación y esterilización de 72 l digital INSERBO

**IA-200BC** *Drying and sterilization oven of 72l digital INSERBO*

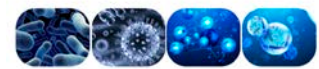

**IA-190 Esterilizador** de 7L rayos ultravioleta (UV)

**IA-190** *7L ultraviolet (UV) sterilizer*



**IA-286 Centrifuga** de 6 tubos

**IA-286** *6-tube centrifuge*



**IA-286A Centrifuga** de 6 tubos con temporizador

**IA-286A** *6-tube centrifuge with timer*

## Baños maría INSERBO de acero Inox, con bandeja protectora

*INSERBO stainless steel waterbaths, with protecting tray*

Los baños maría INSERBO son de acero Inox, tanto la cubeta interior como el mueble exterior. Incorporan de serie termostato de seguridad que desconecta el baño en caso de sobret temperatura. Bandejas protectoras cubre resistencias en acero Inox.

*INSERBO waterbaths are made of stainless steel. They are equipped with a safety thermostat that disconnects the boiler in case of overtemperature. The protecting trays that cover the resistance are also made of stainless steel.*



**IA-208** Analógico, 5 l      **IA-208** Analogical, 20 l  
**IA-208D** Digital, 5 l      **IA-208D** Digital, 20 l



**IA-212** Analógico, 12 l      **IA-212** Analogical, 12 l  
**IA-212D** Digital, 12 l      **IA-212D** Digital, 12 l



**IA-214** Analógico, 20 l      **IA-214** Analogical, 20 l  
**IA-214D** Digital, 20 l      **IA-214D** Digital, 20 l



**Tapas para baños maría**

*Lids for water baths*



**IA-218** Digital, 50 l  
**IA-218** Digital, 50 l



**IA-217** Analógico, 45 l      **IA-217** Analogical, 45 l  
**IA-217D** Digital, 45 l      **IA-217D** Digital, 45 l

CÓDIGO CODE	TEMP. MÁXIMA MAX. TEMPERATURE	CAPACIDAD / LITRE CAPACITY	CONSUMO W	MEDIDAS EXTERIORES EXTERIOR MEASURES			MEDIDAS ÚTILES CM USEFUL MEASURES CM		
				Alto HIGH	Ancho WIDE	Fondo DEEP	Alto HIGH	Ancho WIDE	Fondo DEEP
IA-208/208D	110 °C	5	600	24	33	18	15	30	15
IA-212/212D	110 °C	12	1200	24	36	33	15	33	30
IA-214/214D	110 °C	20	1600	24	53	33	15	51	30
IA-217/217D	110 °C	45	2500	24	63	53	15	62	50
IA-218	110 °C	50	2500	36	89	50	20	74	40

# Baños maría / Agitadores

## Waterbaths / Magnetic stirrer



**IA-202 Baño maría analógico**  
**IA-202 Analogical waterbath**



**IA-202D Baño maría digital**  
**IA-202D Digital waterbath**

Baños maría INSERBO, de 12 l con tapa y bandeja Inox. Con termostato analógico o digital. Para calentar las dosis de semen a 37 °C por agua caliente (\*).

*INSERBO water bath (12 litres) with stainless steel lid and tray. To heat semen (37°C with hot water) (\*). Analogical or digital thermostat*

Imprescindible para mirar muestras de semen en el microscopio (calor uniforme en toda su superficie)

*Essential to study semen samples on the microscope (uniform heating)*



**IA-255 Placa calentable digital INSERBO.**  
**IA-254 Placa calentable digital de precisión INSERBO.**

*IA-255 INSERBO digital heatable plate.*  
*IA-254 INSERBO precision digital heatable plate.*



**IA-139A Platina calentable digital INSERBO**  
 (instalada en microscopio)

*IA-139A INSERBO digital heatable plate (already assembled on microscope)*



**IA-256 Placa calentable para acoplar a carro microscopio**

*IA-256 Heatable plate to attach to microscope trolley*



**IA-244** Agitador magnético INSERBO con calefacción

*IA-244 INSERBO magnetic stirrer with heating*



**IA-244A** Agitador magnético digital INSERBO con calefacción sonda externa

*IA-244A INSERBO heatable magnetic stirrer with external probe*



**IA-244B** Agitador magnético calefactable con sonda externa digital

*IA-244B Heatable magnetic stirrer with digital external probe*



**IA-247** Varilla recoge imanes

**IA-245** Iman de 8 x 39 para agitador magnético

*IA-247 Bar for magnet withdrawal*

*IA-245 8 x 39 magnet for magnetic stirrer*

### Cubetas para colorímetro Colorimeter cubes



**IA-258** 4 caras transparentes paq. de 100 u

*IA-258 4 transparent sides, pack 100 units*



**IA-259** Colorímetro medical CO 7000

**IA-260** Colorímetro CO 7500

*IA-259 Medical colorimeter CO 7000*

*IA-260 Colorimeter CO 7500*



**IN-145B** Contador manual, 5 teclas

*IN-145B Analog counter with 5 keys*

## NEVERAS PARA CONSERVACIÓN DE SEMEN

En INSERBO, SL nos tomamos muy en serio las preocupaciones y problemas de nuestros clientes, por lo que diseñamos y fabricamos todas nuestras cámaras de conservación para que detecten y rectifiquen automáticamente un problema de temperatura antes de que este se manifieste y se dañen los productos en ellas almacenados.

Nuestras neveras de conservación controlan con el máximo de precisión la temperatura ambiente (aire) de su interior en el espacio máximo de tiempo de 1 minuto y, puesto que para variar la temperatura de cualquier sólido o líquido mediante la temperatura ambiente (el aire), es preciso un espacio de tiempo superior al minuto y conseguimos que nuestras neveras obtengan una precisión real de la temperatura del producto a conservar (dosis seminales, muestras, vacunas, etc...) de 0,5 °C a 1 °C , 0,2 °C a 0,5 °C y 0,2 °C a 0,1 °C según el modelo de nevera

### SEMEN CONSERVATION REFRIGERATORS

*We take our customers worries and problems very seriously and for this reason we design and manufacture all our refrigerators in a way that they automatically detect and solve any temperature problems before they arise and consequently avoiding any possible damage of the contents inside the refrigerator*

*Our conservation refrigerators control the inside air temperature with maximum precision and in a maximum period of time of 1 minute. In order to change the temperature of any solid or liquid by means of air temperature a period of 1 minute is required. This means that our refrigerators obtain real precision of the temperature of the contents inside the refrigerator (semen doses, vaccines etc.) from 0.5 °C to 1 °C, from 0.2 °C to 0.5 °C and from 0.2 °C to 0.1 °C depending on the model*



PARA LA BIOSEGURIDAD EN GRANJAS Y CENTROS DE I.A

FOR BIOSAFETY ON FARM AND A.I. CENTERS

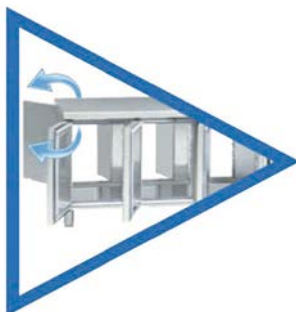

- IA-316A** Nevera de conservación de semen fija 2 puertas dobles pasantes
- IA-316B** Nevera de conservación de semen fija 3 puertas dobles pasantes
- IA-316C** Nevera de conservación de semen fija 4 puertas dobles pasantes

*IA-316A Fixed semen storage refrigerator with 2 pass-through double doors*  
*IA-316B Fixed semen storage refrigerator with 3 pass-through double doors*  
*IA-316C Fixed semen storage refrigerator with 4 pass-through double doors*

**Puertas pasantes** dotadas de bisagras con sistema de retorno automático y fijación de apertura

*Pass-through doors equipped with hinges with automatic return system and opening fixation*

Número de puertas Number of doors	Potencia (kW) Power	Dimensiones (mm) Dimensions
2	0,249	1342 x 778 x 850
3	0,249	1792 x 778 x 850
4	0,332	2242 x 778 x 850



**Nevera** de conservación de semen, 70 l  
*Semen conservation refrigerator (70 l)*

- IA-311** Modelo B (básico)
- IA-310** Modelo N con microprocesador digital de zona neutra
- IA-305** Modelo E con microprocesador digital de alta precisión, 0,1°C con economizador de consumo

- IA-311 "B" model (basic)*
- IA-310 "N" model with digital microprocessor of neutral zone*
- IA-305 "E" model with digital high precision microprocessor (0.1 °C) with consumption economizer*

**Nevera** de conservación de semen, 140 l  
*Semen conservation refrigerator (140 l)*

- IA-314** Modelo N con microprocesador digital de zona muerta
- IA-313** Nevera de conservación de semen fija de 140 l, modelo E con ordenador

- IA-314 "N" model with digital microprocessor of neutral zone*
- IA-313 Semen conservation refrigerator (140 l) "E" model with computer*



**IA-317** Estabilizador de corriente, 220 V  
**IA-317** Current stabilizer, 220V

CÓDIGO CODE	ZONA NEUTRA NEUTRAL ZONE	CAPACIDAD L LITRE CAPACITY	CONSUMO W	MEDIDAS EXTERIORES CM EXTERIOR MEASURES CM			MEDIDAS ÚTILES CM INTERIOR MEASURES CM		
				Alto High	Ancho Wide	Fondo Deep	Alto High	Ancho Wide	Fondo Deep
IA-305/310	SI - YES	70	75	62,5	47	44	52,5	40	34
IA-311	NO	70	75	66,5	47	44	52,5	40	34
IA-313/314	SI - YES	140	90	84	48	48	73,5	40	37
IA-314B	SI - YES	250	128	143	55	58	123	47	44
IA-315	SI - YES	360	200	183	59	60,5	156,5	53,5	44,5
IA-316	SI - YES	600	195	189	77,7	69,5	166	65,5	58

## Neveras Conservation refrigerators



**IA-314B** Nevera de conservación de semen de 250 l Modelo N con microprocesador digital de zona neutra

**IA-314B** Semen conservation refrigerator (250 l) "N" model with digital microprocessor of neutral zone



**IA-315** Nevera de conservación de semen fija de 360 l

**IA-315** Semen conservation refrigerator (360 l)

**IA-316** Nevera de conservación de semen fija de 600 l

**IA-316** Semen conservation refrigerator (600 l)



- \* Termostato con punto decimal y zona neutra
- \* Cerradura con llave
- \* Rejilla protectora en el compresor

- \* Thermostat with decimal point and neutral zone
- \* Lock with key
- \* Protective grille on the compressor



**Nevera para transporte de semen con compresor, 12 V**  
*Semen carrying refrigerator with compressor, 12V*

**IA-335C** 130 l  
**IA-335CA** 100 l



**Nevera de transporte de semen y vacunas con compresor 12 -220V**  
*Semen and vaccines carrying refrigerator with compressor, 12-220V*

**IA-335B** 110 l



**Nevera de transporte para semen, 12-220 V**  
*Semen carrying refrigerator, 12-220V*

**IA-324A** 14 l  
**IA-322A** 21 l  
**IA-320** 35 l



**Nevera de transporte para vacunas, 12-220 V**  
*Carrying refrigerator for vaccines, 12-220V*

**IA-329A** 14 l  
**IA-329D** 21 l  
**IA-332** 35 l



**IA-326 Transformador para neveras de transporte, 220 V-12**

*IA-326 Transformer for carrying fridge, 220 to 12V*



**Nevera de transporte para vacunas con compresor, 12 V**  
*vaccines carrying refrigerator with compressor, 12V*

**IA-331** 25 l



**IA-347A Nevera-bolsa isotérmica de 17 litros**

*IA-347A 17 liter isothermal cooler bag*

# Neveras de transporte / Selladoras

## Semen carrying refrigerators / Sealers



**IA-270 Esterilizador de catéteres**  
automático de 18 catéteres

**IA-270 Automatic catheter sterilizer** (18 units)



**IA-279 Bomba peristáltica digital programable.**  
Para llenado de tubos y botellas

**IA-279 Programmable digital peristaltic pump.** To fill  
bottles and tubes



**IA-281B Selladora manual** para  
envasado de tubos

**IA-281B Manual sealer** for tube packaging



**IA-281A Selladora automática** para  
envasado de tubos

**IA-281A Automatic sealer** for tube packaging



**IA-281 Selladora para envasado de**  
6 a 8 tubos. 2.000 tubos/hora

**IA-281 Sealer for tube packaging** (6 to 8  
tubes). (2,000 tubes/hour)



**IA-282 Gradilla** Inox para selladora de  
tubos

**IA-282A Gradilla** Inox para selladora de  
tubos doble (90, 30 ml)

**IA-282** Stainless steel **holder** for tube packaging

**IA-282A** Stainless steel double **holder** (90, 30 ml)

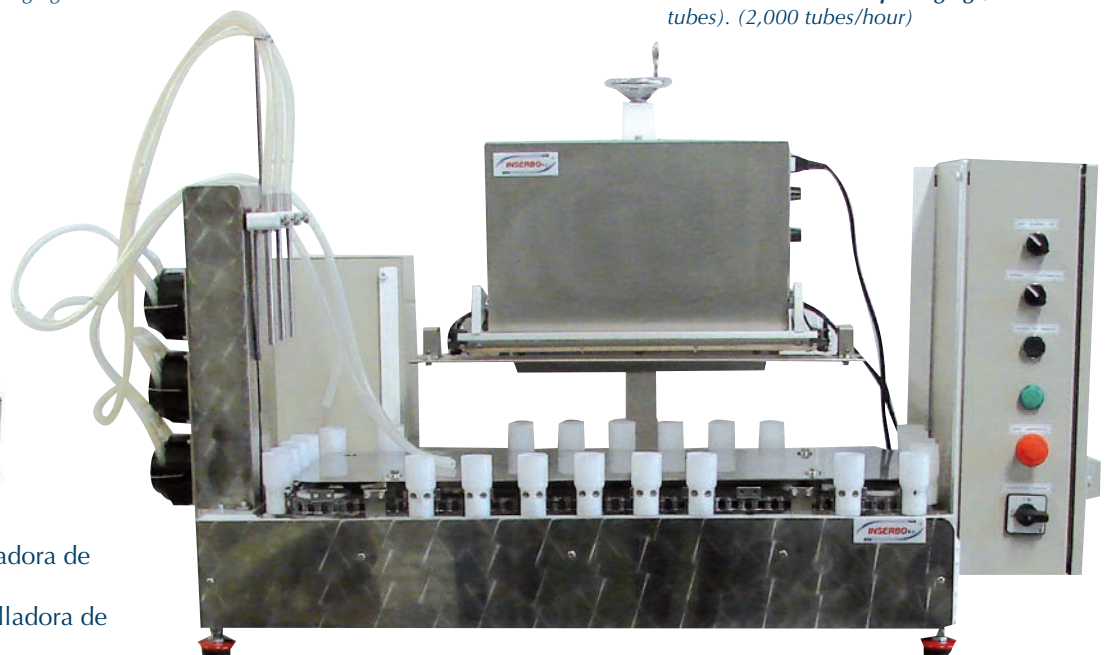

**IA-281C Selladora-envasadora** de tubos automática

**IA-281C Automatic sealing/packaging machine** for tubes



**IA-354** Dispensador de portaobjetos

**IA-354** Slide dispenser



**Portaobjetos**  
**Slides**

**IA-350** Paq. de 50 uds / Box of 50 U

**IA-351** Paq. de 72 uds / Box of 72 U



**IA-355A** Cubreobjetos

18 x 18, alemán, paq. de 100 uds

**IA-355A** Slide covers 18 x 18, german model, box of 100 pcs



**Cubreobjetos**  
**Slide cover**

**IA-355 / IA-355A** 18 x 18, paq. de 100 uds

**IA-360** 20 x 20, paq. de 100 uds

**IA-362** 22 x 22, paq. de 100 uds

**IA-365** 24 x 32, paq. de 100 uds

**IA-355 / IA-355A** 18 x 18. Box of 100 pcs

**IA-360** 20 x 20. Box of 100 pcs

**IA-362** 22 x 22. Box of 100 pcs

**IA-365** 24 x 32. Box of 100 pcs

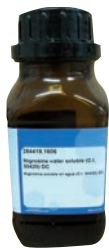

**IA-375** Aceite de inmersión, frasco de 100 ml

**IA-730** Nigrosina de 25 g

**IA-735** Eosina para microscopía de 25 g

**IA-725** Cafeína pura de 250 g

**IA-375** Immersion oil, bottle of 100 ml

**IA-730** Nigrosine, 25 g

**IA-735** Eosine, 25 g

**IA-725** Pure caffeine, 250 g



**IA-380** Tolueno para la limpieza de las ópticas de los microscopios, frasco de 1 l

**IA-380** Toluene, bottle of 1 l, to clean microscope accessories



**IA-557** Varilla de vidrio para agitar

**IA-557** Glass cane to shake

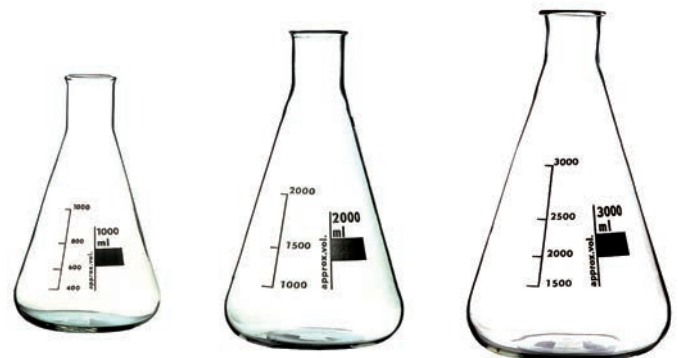

**Erlenmeyer**  
**Erlenmeyer**

**IA-504** 500 ml

**IA-505** 1.000 ml

**IA-510** 2.000 ml

**IA-515** 3.000 ml

**IA-517** 5.000 ml

# Material de laboratorio

## Laboratory material

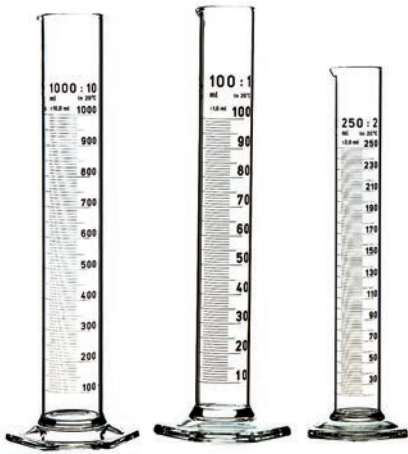

**Probeta**  
*Test tube*

- IA-518A 25 ml
- IA-519 100 ml
- IA-520 250 ml
- IA-525 500 ml
- IA-530 1.000 ml
- IA-531 2.000 ml
- IA-531A 500 ml de plástico - *Plastic test tube*



**IA-547 Botella de vidrio**  
con tapón de rosca y tubo  
de salida, 5 l

*IA-547 Glass bottle with screw  
cap and exhaust pipe (5 l)*



**IA-545 Botella de vidrio con**  
tapón de rosca, 1.000 ml

*IA-545 Glass bottle with screw cap  
(1,000 ml)*

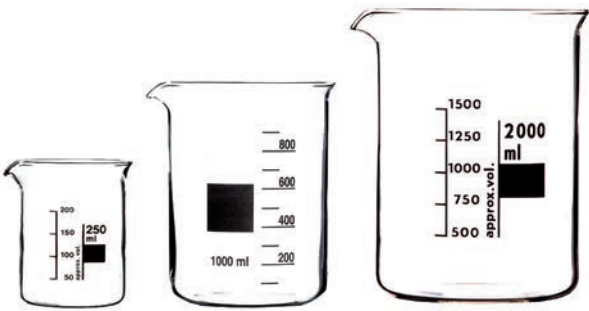

**Vaso de precipitados**  
*Beaker*

- IA-535 250 ml F/B (L/F)
- IA-536 250 ml F/A (T/F)
- IA-539 400 ml F/A (T/F)
- IA-540 400 ml F/B (L/F)
- IA-541 1.000 ml F/B (L/F)
- IA-542 2.000 ml
- IA-543 3.000 ml
- IA-544 5.000 ml



**IA-546 Botella de vidrio con tapón**  
de rosca, 250 ml

*IA-546 Glass bottle with screw cap (250  
ml)*



**Frasco lavador**  
*Cleaning flask*

- IA-550 1.000 ml
- IA-555 500 ml



**IA-560 Botella de plástico con**  
tapón de rosca, 1.000 ml

**IA-565 Botella de plástico con**  
tapón de rosca, 500 ml

*IA-560 Plastic bottle with screw cap  
(1000 ml)*  
*IA-565 Plastic bottle with screw cap  
(500 ml)*

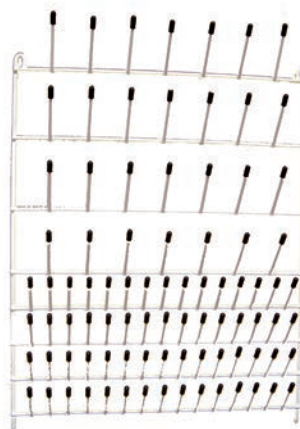

**Escurreidor**  
*Drainer*

- IA-610A Con 44 terminales
- IA-610B Con 88 terminales

*IA-610A with 44 terminals*  
*IA-610B with 88 terminals*



**IA- 610C Escurreidor de**  
sobremesa y colgante, con 55  
terminales

*IA-610C Table and hanging draining  
board with 55 terminals*

**Jarra de plástico**  
Plastic jar

- IA-566** 500 ml
- IA-566A** 1.000 ml
- IA-567** 2.000 ml
- IA-569** 3.000 ml
- IA-568** 5.000 ml

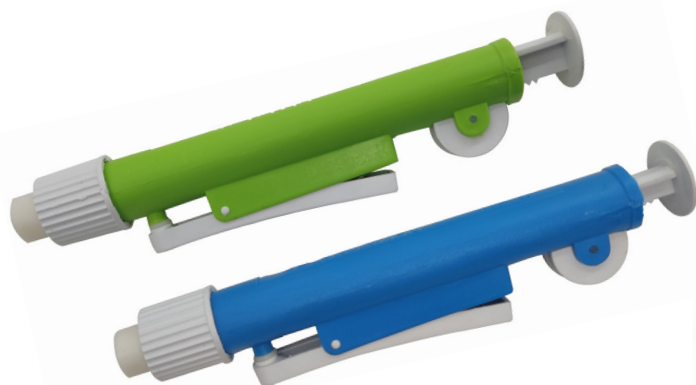

- IA-571** Aspirador para pipetas verde, de 2 a 10 ml
- IA-570** Aspirador para pipetas azul, 1 y 2 ml

- IA-571** Green aspirator for pipettes (2 ml to 10 ml)
- IA-570** Blue aspirator for pipettes (1 ml and 2 ml)



**IA-572/IA-572C/IA-572D**

**Pipetas automáticas fijas:** desde 10 microlitros hasta 1 ml

**IA-572A/IA-572B/IA-572E**

**Pipetas automáticas graduables:** desde 0,2-2 microlitros hasta 1-10 ml

**IA-573** Puntas micropipetas amarillas, de 5 a 200 ml, paq. 1.000 uds

**IA-574** Puntas micropipetas azules, de 100 a 1.000 ml, paq. 1.000 uds

**IA-572/IA-752C/IA-752D**

**Fixed automatic pipettes:** from 10 microliters to 1 ml

**IA-572A/IA-752B/IA-752E**

**Adjustable automatic pipettes:** from 0.2-2 microliters to 1-10 ml

**IA-573** Box of 1000 disposable yellow **points for micropipette** (5 to 200 ml)

**IA-574** Box of 1000 disposable blue **points for micropipette** (100 to 1,000 ml)



- IA-575** Pipeta aforada de 1 ml
- IA-576** Pipeta graduada de 1 ml
- IA-576A** Pipeta graduada de 2 ml
- IA-577** Pipeta graduada de 5 ml
- IA-578** Pipeta graduada de 10 ml

- IA-575** Gage pipette (1 ml)
- IA-576** Graduated pipette (1 ml)
- IA-576A** Graduated pipette (2 ml)
- IA-577** Graduated pipette (5 ml)
- IA-578** Graduated pipette (10 ml)



- IA-502** Pipetas Pasteur de plástico, paq. 500 uds
- IA-502A** Pipetas Pasteur de plástico graduadas, paq. 500 uds

- IA-502** Plastic **Pasteur pipettes**, Box of 500 units
- IA-502A** Graduated plastic **Pasteur pipettes**, Box of 500 units



- IA-500** Pipetas Pasteur de vidrio, cortas, paq. de 250 uds
- IA-501** Pipetas Pasteur de vidrio, largas, paq. de 250 uds

- IA-500** Short **Pasteur pipettes**, box of 250 units
- IA-501** Long **Pasteur pipettes**, box of 250 units

# Material de laboratorio Laboratory material

**IA-580 Matraz  
aforado de 100 ml**

**IA-580 Volumetric flask  
(100 ml)**

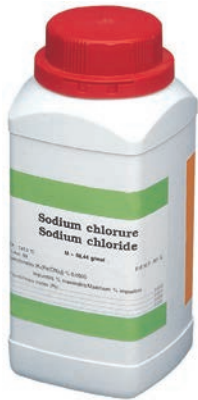

**IA-705 Cloruro  
sódico de 1 kg**

**IA-705 Sodium  
chloride (1 kg)**



**IA-711 Formaldehído,  
frasco de 1.000 ml**

**IA-711 Formaldehyde, flask of  
1,000 ml**



**IA-582 Fórmula  
concentrada para 10  
análisis de semen**

**IA-582 Concentrated  
formula for 10 semen  
tests**

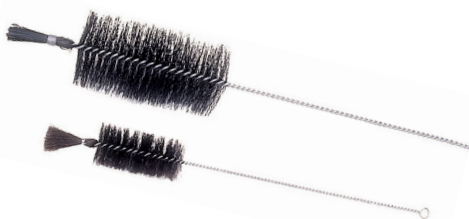

**Escobillón para limpiar material de vidrio  
Brush to clean glass material**

**IA-590 pequeño  
IA-595 grande  
IA-589 mini  
IA-589A mini corto**

**IA-590 Small  
IA-595 big  
IA-589 Mini  
IA-589A Short mini**



**Cámara de Burquer**

**IA-585 Doble con pinzas  
IA-587 Doble con pinzas, líneas  
brillantes  
IA-587A Doble sin pinzas, líneas  
brillantes**

**Bürker chamber**

**IA-585 Double with clamps  
IA-587 Double with clamps, bright lines  
IA-587A Double without clamps, bright  
lines**



**IA-370 Cubreobjetos para cámara de Burquer,  
paq. de 10 uds**

**IA-370 Slide covers for Bürker chamber, box of 10 units**



**DS-415 Dosificador  
de jabón y gel aut.  
por infrarrojos**

**DS-415 Infrared  
automatic soap and  
gel dispenser**



**DS-420 Dosificador  
de jabón manual**

**DS-420 Manual soap  
dispenser**

**Cámara de Neubauer**

**IA-900 Doble con pinzas  
IA-901 Doble sin pinzas**

**Neubauer chamber**

**IA-900 Double with clamps  
IA-901 Double without clamps**



**IA-588 Embudo de cristal**

**IA-588 Glass funnel**



**Con PH neutro  
para limpiar el  
material de vidrio  
With neutral PH  
to clean the glass  
material**

**IA-599 Detergente de laboratorio  
GLASSGEN, 5 l**

**IA-599 Laboratory detergent GLASSGEN 5 l**



**IA-624A** Tapón con grifo para garrafa de agua bidestilada, 25 l

**IA-624A** Cap with exhaust pipe for bidistilled water decanter (25 l)

**Agua bidestilada ultrapura**  
*Ultrapure bidistilled water*

- IA-623** 1 l
- IA-621** 5 l
- IA-624** 25 l



**IA-623A** Agua bidestilada ultrapura, Bag in Box de 25 l

**IA-623A** Ultrapure bidistilled water. Box of 25 l



**IA-623B** Agua bidestilada ultrapura con grifo, Bag in Box de 25 l

**IA-623B** Ultrapure bidistilled water with exhaust pipe. Box of 25 l



# Material de laboratorio Laboratory material



**IA-604 Gasas estériles** para la extracción de semen, paq. de 100 uds (20 sobres de 5 uds)

**IA-604 Sterile gauze** for semen extraction, box of 100 units (20 bags of 5 pcs)



**IA-607 Filtros para semen**, paq. de 200 uds

**IA-607 Semen filters**, box of 200 pcs



**IA-605 Termo para recogida de semen**

**IA-605 Thermal semen collection flask**



**IA-605A Termo para recogida de semen** INSERBO

**IA-605A INSERBO Thermal semen collection flask**



**IA-615 Diluyente para semen de 7 días MR-A**

**IA-615 MR-A semen extender (7 days)**



**IA-534A Vaso desechable liso sin tapa**, 1 l

**IA-534B Vaso desechable estriado sin tapa**, 1 l

**IA-534C Tapa para vaso desechable**, 1 l

**IA-534A Cup of 1l. Disposable smooth without lid**

**IA-534B Cup of 1l. Disposable striated without lid**

**IA-534C Disposable cup lid (1 l)**



**Vaso de plástico para extracción de semen**  
**Plastic vessel for semen extraction**

**IA-532 Vaso con tapa**

**IA-533 Vaso sin tapa**

**IA-534 Tapa hermética**

**IA-532 Plastic vessel with lid**

**IA-533 Plastic vessel without lid**

**IA-534 Hermetic lid**



**IA-620 Diluyente para semen tipo BTS modificado**

**IA-620 BTS semen extender, modified type**



**IA-644 Colorante para semen, no espermicida**

**IA-644 Non-spermicidal colorant for semen**



**IA-605B Calentador** recogida de semen de 6 vasos, a baterías

**IA-605B Battery semen collection heater for 6 cups**



**IP-375 Guantes de látex** libres de polvo (no espermicidas), paq. de 100 uds, varias tallas

**IP-375 Dust-free latex gloves** (non spermicide) 100 pcs package, several sizes



**IP-135 Guantes de plástico desechables**, paq. de 100 uds

**IP-135 Disposable plastic gloves.** 100 units package





**IA-625E Toallitas "Biodegradables"** para higiene de cerdas, no espermicida, cubo de 1.000 uds

**IA-625A "Biodegradable" wet wipes** for sows hygiene, bucket of 800 pcs (non spermicide)



**IA-625A Toallitas desinfectantes** para higiene de cerdas, no espermicida, cubo de 800 uds

**IA-625A Disinfectant wet wipes** for sows, bucket of 800 pcs (non spermicide)

## TUBOS Y BOTELLAS CON SISTEMA ABREFÁCIL A.I. BOTTLES AND TUBES WITH EASY OPEN SYSTEM



**IA-630 Botella dosis** de semen completa de 100 ml, caja de 500 uds

**IA-630 Complete dose semen bottles** of 100 ml, box of 500 units



**IA-632 Botella dosis blanda** para semen con tapón de 100 ml, caja de 500 uds (tapón rojo, azul y verde)

**IA-632 Soft dose bottles** for semen 100 ml with cap, box of 500 units (red, blue and green cap)



**IA-638 Tubos soldables extrafinos** para dosis de semen INSERBO, 30 ml, caja de 2.000 uds

**IA-638 INSERBO extra thin tube** for semen doses, 30 ml, box of 2,000 pcs

**Todos los modelos incluyen abre fácil**  
**All models include easy open**

**IA-637A Tubos soldables extrafinos** para dosis de semen INSERBO, 95 ml, paq. de 1.500 uds

**IA-637A INSERBO extra thin tube** for semen doses, 95 ml, box of 1,500 pcs

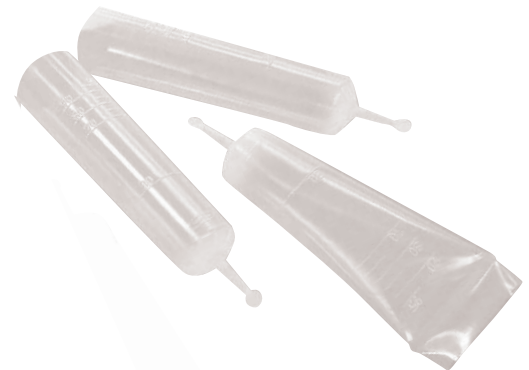

**IA-608C Adaptador de grifo** para bolsa de I.A.

**IA-608C Tap adaptor** for bag IA-608B



**Bolsas para I.A.** para semen, paq. de 100 uds  
**A.I. bags** for semen, box of 100 pcs

**IA-608B Bolsas para semen** con grifo y boquilla, 5 l

**IA-608B Bags** for semen with tap. 5 l

**IA-608** 5 l

**IA-609** 2 l

**IA-608A** 5 l, con troquel para colgar / with a hole to hang

# CÁNULA POSTCERVICAL INSERBO

## INSERBO INTRA-UTERINE CANNULA

Única en el mundo con 4 salidas  
*The only one with 4 holes*

### **Multiposición**

Más fácil, más rápido

**¡Mejor!**

Sin problemas de  
posición

### ***Multiposition***

*easier, faster, better  
avoids position problems*

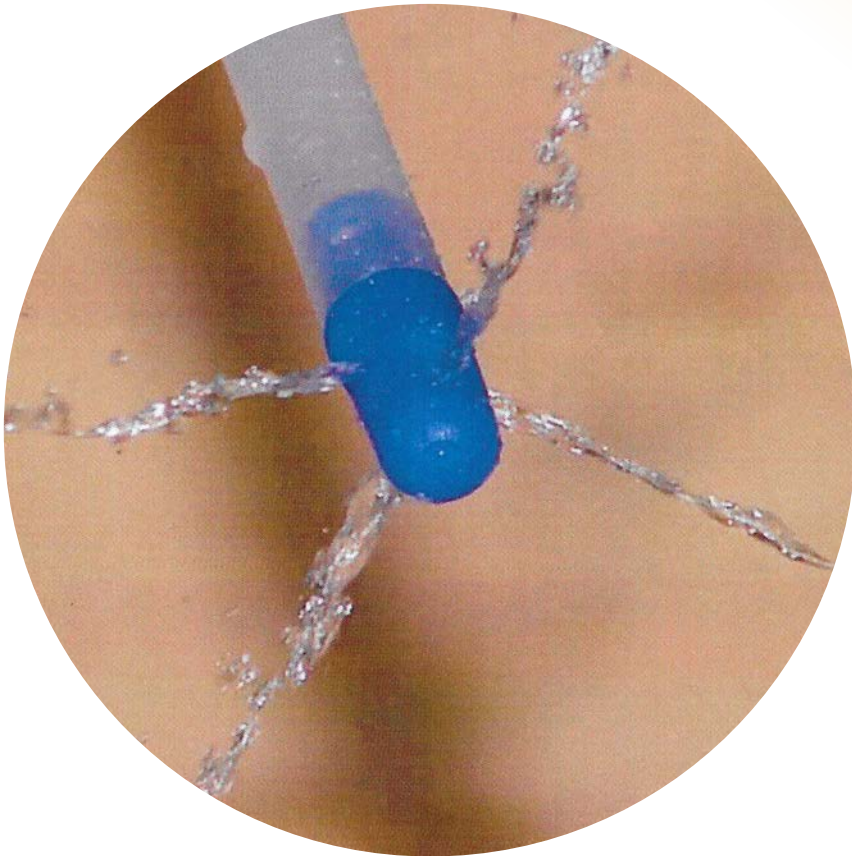

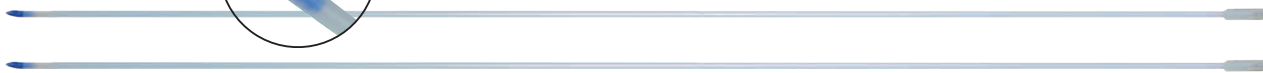
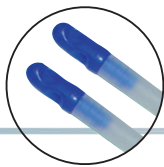

**IA-485** Cánula postcervical INSERBO estéril para I.A., paq. de 2 uds

*IA-485 INSERBO sterile A.I. **intra-uterine cannula**, bag of 2 pcs*

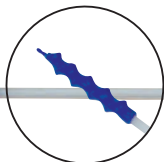

**IA-492** Cánula postcervical INSERBO con catéter espiral azul paq. 1 u.

*IA-492 INSERBO A.I. **intra-uterine cannula** with blue spiral catheter*

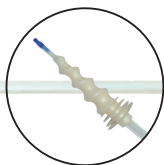

**IA-490** Cánula postcervical INSERBO con catéter antirreflujo paq. 1 u.

*IA-490 INSERBO **intra-uterine cannula** with antiflowing back catheter*

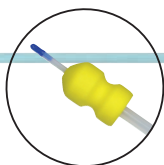

**IA-495** Cánula postcervical INSERBO con catéter de esponja sin trasera paq. 1 u.

*IA-495 **Intra-uterine cannula** with foam catheter*

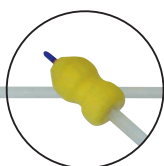

**IA-498** Cánula postcervical INSERBO con catéter de esponja con trasera paq. 1 u.

*IA-498 INSERBO **intra-uterine cannula** with foam catheter end part*

# Cánulas postcervicales con catéter

## *Intra-uterin cannulas with catheter*



**IA-478Y** Cánula postcervical naranja, paq. de 5 uds

*IA-478Y* Orange *intra-uterine cannula*, bag of 5 pcs



**IA-478C** Cánula postcervical naranja con catéter azul, sin trasera, paq. de 5 uds

*IA-478C* Orange *intra-uterine cannula* with blue catheter without end part, bag of 5 pcs

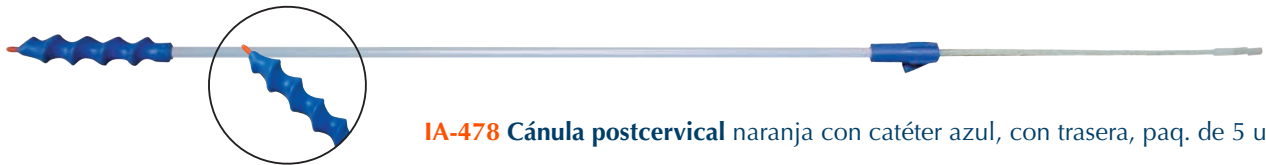

**IA-478** Cánula postcervical naranja con catéter azul, con trasera, paq. de 5 uds

*IA-478* Orange *intra-uterine cannula* with blue catheter with end part, bag of 5 pcs



**IA-478B** Cánula postcervical naranja con catéter antirreflujo

*IA-478B* Orange *intra-uterine cannula* with antiflowing back catheter



**IA-478A** Cánula postcervical naranja con catéter de esponja, sin trasera, paq. de 5 uds

*IA-478A* Orange *intra-uterine cannula* with foam catheter without end part, bag of 5 pcs



**IA-478D** Cánula postcervical naranja con catéter de esponja, con trasera, paq. de 5 uds

*IA-478D* Orange *intra-uterine cannula* with foam catheter, with end part, bag of 5 pcs



**IA-430 Catéter desechable** antirreflujo INSERBO, paq. de 4 uds, caja de 1000 uds

**IA-430** INSERBO *disposable catheter*, anti-flowing back, bag of 4 pcs, box of 1000 units



**IA-470 Catéter desechable** con tapón trasero INSERBO, paq. de 5 uds, caja de 500 uds

**IA-470** INSERBO *disposable catheter* with end part, bag of 5 pcs, box of 500 units



**IA-475 Catéter desechable** naranja INSERBO, paq. de 5 uds, caja de 500 uds

**IA-475** INSERBO orange *disposable catheter*, bag of 5 pcs, box of 500 units



**IA-477 Catéter desechable** espiral azul, con tapón trasero, paq. de 5 uds, caja de 500 uds

**IA-477** Blue spiral *disposable catheter*, bag of 5 pcs, box of 500 units



**IA-405 Catéter de caucho** nacional tipo melrouse

**IA-405** Melrouse type national *rubber catheter*

# Catéteres / Gel lubricante

## Catheters / Lubricant gel



**IA-468** Catéter **desechable** tipo esponja para nulíparas con tapón trasero, paq. de 5 uds, caja de 500 u

**IA-468** Foam **disposable catheter** with end part, for gilts, bag of 5 pcs, box of 500 pcs



**IA-469** Catéter **desechable** tipo esponja para nulíparas sin trasera paq. 5 u, caja de 500 u

**IA-469** Foam **disposable catheter** without end part, for gilts, bag of 5 pcs, box of 500 pcs



**Catéter desechable** tipo esponja INSERBO, caja de 500 u  
*INSERBO foam **disposable catheter**, box of 500 pcs*

**IA-462** Envasado, paq. de 1

**IA-462** 1pcs/bag

**IA-464** Envasado, paq. de 5 uds

**IA-464** 5 pcs/bag

**IA-464B** Envasado, paq. de 25 uds

**IA-464B** 25 pcs/bag



**Catéter desechable** tipo esponja con tapón trasero INSERBO, caja de 500 u  
*INSERBO foam **disposable catheter** with end part, box of 500 pcs*

**IA-467** Envasado paq. 1 u

**IA-467** 1pcs/bag

**IA-465** Envasado, paq. de 5 uds

**IA-465** 5 pcs/bag

**IA-467B** Envasado, paq. de 25 uds

**IA-467B** 25 pcs/bag



**Adaptador-Alargo** para catéteres  
*Adapter-Extensiom for catheters*

**IA-480** Paquete de 200 unidades

**IA-480** Pack of 200 units

**IA-481** Paquete de 5 unidades

**IA-481** Pack of 5 units



**IA-775 / IA-780 Gel lubricante-desinfectante** ginecológico no espermicida de 1 y 5 l

*IA-775 / IA-780 Disinfectant-lubricant gynecological gel (1 and 5 l) (no spermicide)*



**IA-699 Vaselina líquida** de 1 l  
*IA-699 Liquid vaseline (1 l)*

**IA-698A Vaselina líquida** de 5 l  
*IA-698A Liquid vaseline (5 l)*

**Spray para detectar celo en cerdas**  
*Spray to detect heat in sows*

**IA-612** 80 ml  
**IA-612A** 250 ml



**IA-611B Alforja** para inseminación artificial "manos libres" INSERBO

*IA-611B INSERBO hands free holder for artificial insemination*



**IA-640 Cúter** para abrir botellas y tubos de inseminación artificial

*IA-640 Cutter to open artificial insemination bottles and tubes*



**IA-641 Etiquetadora** para dosis de semen

*IA-641 Labelling machine for semen samples*

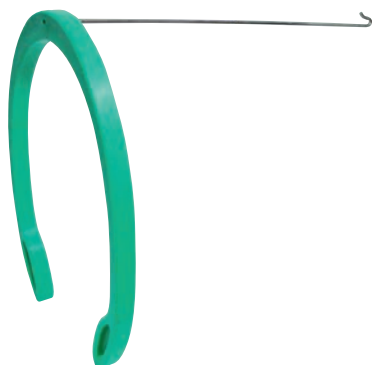

**IA-611C Arco** para inseminación de cerdas múltiparas, verde

*IA-611C Green A.I. buddy for sows*



**IA-611D Arco** para inseminación de cerdas nulíparas, amarillo

*IA-611D Yellow A.I. buddy for gilts*

# Alfombras / Carro inseminación / Botes

## Rugs / A.I. trolleys / Bottles

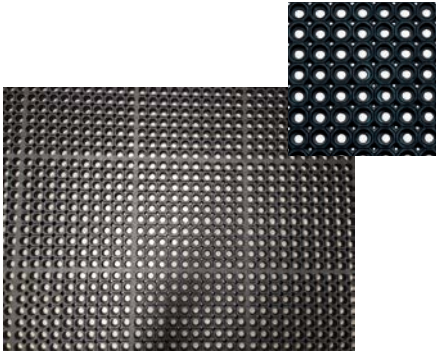

**IA-675 Alfombra antiresbalante** para sala de montar, 150 x 100 cm

**IA-675A Alfombra antiresbalante** para sala de montar extra, 152 x 91 cm

**IA-675 Antislippery alveolar rug** for mating room (150 x 100 cm)

**IA-675A Antislippery alveolar rug** for mating room (152 m x 91 cm)



**IA-676 Alfombra círculos negros,** rollo de 10 m x 1,5 m x 3 mm

**IA-676 Black circles rug** 10 m roll 1.5 m x 3 mm



**IA-828 Levamix Nucleus,** 5 kg.

**IA-828 Nucleus Levamix,** 5 kg



**Apoyo desmontable / Detachable support**

**IA-670 Potro** para monta fijo y móvil (madera forrada) con apoyo

**IA-670 Mating table,** wood lined, fixed and mobile with support



**IA-680 Rollo de papel** para laboratorios "grande" (celulosa pura)

**IA-685 Portarrollos** de papel Inox de sobremesa y colgante.

**IA-680 Laboratory paper roll "big"** (pure cellulose)

**IA-685 Stainless steel table and hanging paper roll carrier**



**IA-686 Portarrollos** de papel de pie fijo

**IA-686 Fixed paper roll carrier**



**IA-679 Rollo de papel** para laboratorios "pequeño" (celulosa pura)

**IA-679 Laboratory paper roll "small"** (pure cellulose)

**IA-668A Carro-mesa para inseminación artificial** Inox. De simple manejo, estrecho, práctico y de fácil maniobrabilidad. Puede adaptarse al baño maría y calentador de dosis de semen de la página 183

**IA-668A Trolley for artificial insemination.** Easy to handle convenient and narrow. Adjustable to water bath and semen heater Ref. IA-202, IA-203 (page 165).

**No incluye accesorios, catéteres, etc.**  
Accessories not included



**JG-590 Placa de Petri**, 55 x 14 mm

*JG-590 Petri plate, 55x14mm.*



**JG-582A Botella esteril con tiosulfato** para análisis de agua, de 1.000 ml

*JG-582A Sterile bottle with thiosulfate for water analysis, 1,000 ml*



**JG-580 Bote para recogida de muestras**, 2.000 ml

*JG-580 Samples collecting pot, 2,000 ml*



**Botella con goma y tapón**  
*Bottle with rubber and top*

- AG-292** 100 ml
- AG-293** 250 ml
- AG-294** 500 ml
- AG-295** 1.000 ml



**AG-296 Tapón de goma** para botella de 250, 500 y 1000 ml

*AG-297 Rubber stopper for 250, 500 and 1000 ml*



**AG-297 Tapón de plástico abierto** para botella de 250, 500 y 1000 ml

*AG-297 Open plastic cap for 250, 500 and 1000 ml*



**Bote para recogida de muestras**  
*Samples collecting pot*

- JG-569** 40 ml
- JG-570** 100 ml
- JG-571** estéril, 100 ml

*JG-569 40 ml*  
*JG-570 100 ml*  
*JG-571 100 ml sterile*



**Tarro de boca ancha con tapa y obturador**  
*Wide mouth with tap and shutter*

- JG-584** 1.000 ml
- JG-585** 500 ml
- JG-586** 250 ml



**JG-578 Bote 30 ml con tapón de seguridad**

*JG-578 30 ml pot with safety cap*



**REGULABLE  
ADJUSTABLE**



**AG-299E Pistola pulverizadora profesional (Sin botella)**

**AG-299E Professional spray gun (Without bottle)**

**AG-299D Botella con pulverizador de 750ml (alta calidad)**

**AG-299D 750 ml spray bottle (high quality)**



**JG-540A Tubos vacios, 5 ml con etiqueta y tapón verde, paq. de 1000 uds**

**JG-540B Tubos vacios, 10 ml con etiqueta y tapón verde, paq. de 500 uds**

**JG-540A Empty tubes, 5 ml with label and green cap, box of 1000 pcs**

**JG-540B Empty tubes, 10 ml with label and green cap, box of 500 pcs**



**JG-505 MONOVETTE L suero de 9 ml, caja 50 uds**

**JG-505 MONOVETTE L serum 9 ml, box 50 units**



**JG-540 Tubo vacios, 5 ml, paq. de 100 uds**

**JG-541 Tubo presuero, 5 ml, paq. de 100 uds**

**JG-540 Serum tubes, 5 ml, box of 100 pcs**

**JG-541 Empty tubes, 5 ml, box of 100 pcs**



**JG-575 Tubo para muestras de 13 ml, paq. de 100 uds**

**JG-575 Samples collecting tube, 13 ml, 100 units package**

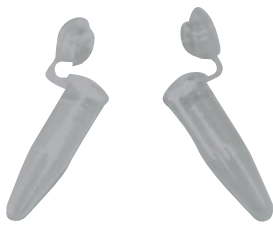

**JG-595 Microtubos** EPPENDORF, 1,5 ml, paq. 1.000 uds

*JG-595 EPPENDORF microtube, 1.5 ml, pack of 1,000 units*



**JG-536 Tubo para muestras** de 5 ml, paq. 1.000 uds

*JG-536 5 ml sample tube, pack of 1,000 units*



**JG-535 Tubo para muestras** de 5 ml, con tapón (separado), paq. 2.000 uds

*JG-535 5 ml sample tube, with stopper (separate), pack of 2,000 units*



**IO-164 Hisopo** veterinario LARYNGEAL extralargo 27 cm, paq. 100

*IO-164 LARYNGEAL extra large veterinary swab 27 cm. Bag with 100 pcs*



**IO-160 Hisopo** estéril de 15 cm para recogida de muestras (con medio de cultivo)

**IO-161 Hisopo** estéril de 15 cm para recogida de muestras (sin medio de cultivo)

*IO-160 Sterile swab (15 cm) to obtain samples (With transport medium)*

*IO-161 Sterile swab (15 cm) to obtain samples (Without transport medium)*



**JG-567 Cuerda natural** para recolección fluidos naturales

*JG-567 Natural rope for collecting natural fluids*



**JG-568 Kit de recolección de fluidos orales** para cerdos

*JG-568 Oral fluid collection and testing kit for pigs*



**IA-909 Gradilla de aluminio** en forma de Z para 50 tubos, hasta 17 mm Ø

*IA-909 Aluminium tube-rack; Z form, for 50 tubes, up to 17 mm Ø*

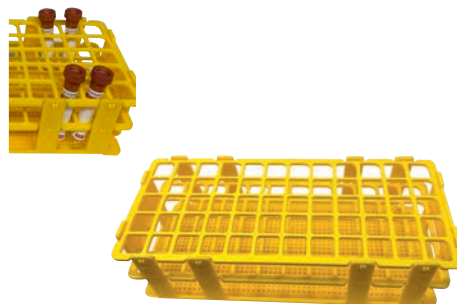

**IA-911 Gradilla de plástico** para 60 tubos, hasta 16 mm Ø

*IA-911 Plastic tube-rack for 60 tubes, up to 16 mm Ø*

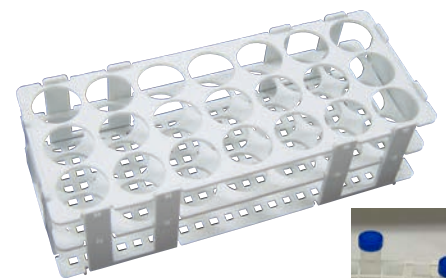

**IA-912 Gradilla de plástico** para 21 tubos, hasta 30 mm Ø

*IA-912 Plastic tube-rack for 21 tubes, up to 30 mm Ø*

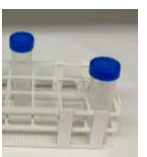

# Extracción de sangre

## Blood collection



- JG-563** Aguja VACUTAINER 38 x 1,2, paq. de 100 uds
- JG-564** Aguja VACUTAINER 25 x 1,2, paq. de 100 uds
- JG-562** Aguja VACUTAINER 25 x 0,9, paq. de 100 uds

- JG-563** VACUTAINER needles 38G x 1 1/2", box of 100 pcs
- JG-564** VACUTAINER needles 25G x 1", box of 100 pcs
- JG-562** VACUTAINER needles 25G x 0.9", box of 100 pcs



- JG-558** Aguja VACUETTE 38 x 1,2, paq. de 100 uds
- JG-559** Aguja VACUETTE 25 x 1,2, paq. de 100 uds

- JG-558** VACUETTE needles 38G x 1 1/2", box of 100 pcs
- JG-559** VACUETTE needles 25G x 1", box of 100 pcs



- JG-565** Adaptador para tubos VACUTAINER cuadrado
- JG-566** Adaptador para tubos VACUTAINER redondo
- JG-566A** Adaptador para tubos VACUETTE

- JG-565** Adapter for VACUTAINER tubes, square
- JG-566** Adapter for VACUTAINER tubes, round
- JG-566A** Adapter for VACUETTE tubes



- JG-546** Tubos VACUETTE plástico de 4,5 ml, paq. 50 uds
- JG-546C** Tubos VACUETTE 4,5 ml, "con código de barras" paq. 50 uds

- JG-546** VACUETTE plastic tubes 4.5 ml, box of 50 pcs
- JG-546C** VACUETTE tubes 4.5 ml, "with barcode" box of 50 pcs



- JG-545** Tubos VACUTAINER de 5 ml, paq. de 40 uds
- JG-545** VACUTAINER tubes 5 ml, box of 40 pcs



- JG-545A** Tubos VACUTAINER con EDTA de 4 ml, 10 paq. de 100 uds
- JG-545A** VACUETTE tubes with EDTA.4 ml, 10 pack of 100 units



# Medidores de humedad

## Humidity tester



**DG-180** Medidor de humedad para paja y heno con lanza, 50 cm

*DG-180* Moisture meter for straw and hay with lance, 50 cm



**DG-185** Medidor de temperatura Inox para grano con lanza, 280 cm

*DG-185* Stainless steel temperature gauge for grain with lance, 280 cm

**DG-175** Medidor de humedad para grano

*DG-175* Moisture meter for grain





www.inserbo.com  
Tel: +34 973 75 03 13 Fax: +34 973 75 17 72  
Pol. Industrial Torrefarrera C/ Ponent, nº 3  
25123 TORREFARRERA (LLEIDA) SPAIN  
inserbo@inserbo.com

**INSERFIX**®

**STARVET**®

**STARVET**®  
*forte*

**GLASSGEN**®

**FUTURE-1**®

**SERBONET**®

**GROTEERMAN**®

investigación  
*investigation*



**INSERBO** S.L.



Tel.: +34 973 75 03 13 Fax: +34 973 75 17 72 Pol. Industrial Torrefarrera  
C/ Ponent, nº 3 | 25123 TORREFARRERA (LLEIDA) SPAIN  
inserbo@inserbo.com