



**INSTRUMENTAL
VETERINARIO Y GANADERO**

**INSEMINACIÓN ARTIFICIAL
PORCINA, CUNÍCOLA Y VACUNA**

**VETERINARY
AND LIVESTOCK INSTRUMENTS**

**PORCINE, RABBIT AND CATTLE
ARTIFICIAL INSEMINATION**



**diseño
design**



**tecnología
technology**



**desarrollo
development**







INSERBO nace el año 1992 con una clara vocación de servicio integral en el mundo del instrumental veterinario y material ganadero.

Integrado por un equipo de profesionales con más de 35 años de experiencia en el sector, siempre se ha caracterizado por la fabricación, innovación, investigación, desarrollo, distribución y promoción de una seleccionada línea de productos de primera calidad, con más de 6.000 productos en nuestro catálogo compuesto de instrumental veterinario, material ganadero e inseminación artificial para vacuno, porcino y conejos.

Este reconocimiento y el afán de dar cada día un mayor servicio nos ha permitido expandirnos a escala nacional e internacional y disponer de unas nuevas instalaciones con más de 6.000 m², en las cuales se ubican oficinas, talleres de fabricación, laboratorio de contrastación seminal, almacenes y talleres de servicio técnico. Disponemos además de Departamento de Investigación y Desarrollo, Departamento Técnico y de Asesoramiento.

INSERBO cuenta con maquinaria propia de última generación para la fabricación de nuestros productos. Actualmente fabricamos muchos de los productos que comercializamos. **INSERFIX**, **STARVET**, **GLASSGEN**, **FUTURE-1**, **SERBONET** y **GROTEERMAN**, marcas registradas por **INSERBO SL**, se utilizan para la denominación de la mayoría de productos que fabricamos, así como diversas patentes en nuestro haber.

En este catálogo que tienen en sus manos podrán encontrar de manera fácil y ordenada todos los productos necesarios para el desarrollo diario de las granjas y el instrumental adecuado para los veterinarios, con la garantía de la máxima calidad.

***INSERBO** came into being in 1992 with the intention of offering a complete service in the sector of veterinary instruments and equipment for stock.*

Inserbo, formed by a professional group of people, with more than 25 years of experience in the sector, has always been characterised by the production, innovation, investigation, development, distribution and promotion of a selected line of more than 6,000 first quality products, our catalogue consists of veterinary and breeding products and artificial insemination of cattle, pigs and rabbits.

This recognition and the every day effort to offer a better service, have made possible our growth into the national and international market our new facilities with more than 6,000 m² consist of the office, the production workshop, the laboratory of seminal contrasting, the storehouse and the technical service workshop are located.

Moreover, we have an Investigation and Development Department, a Technical Department and an Advice Department in order to give further assistance.

***INSERBO** owns latest generation machinery for the production process. At present, we produce many of the items we distribute, **INSERFIX**, **STARVET**, **GLASSGEN**, **FUTURE-1**, **SERBONET** and **GROTEERMAN**, are the registered trademarks we use for naming the majority of items we produce, as several patents of our own.*

In this catalogue you are holding, you will find, in an easy and clear way and with the best quality guaranteed, all the necessary products for the daily development of farms and the appropriate veterinary instruments.

Índice

A	
Abrebocas	114-141-145
Abrebocas de metal, mod. SCHULZE para vacuno y equino	141
Abrebocas para sondas esofágicas	145
Abrebocas SMITH-BAXTER	114
AC. poliglicólico (PGA)	118
Adaptador para tubos VACUTAINER	239
Adaptador para tubos VACUETTE	239
Agitadores magnéticos	216
Ágrafes	109-119-124
Agua bidestilada	226
Agujas de aspiración	169-177
Agujas hipodérmicas reusables	158-159-160
Agujas hipodérmicas desechables	160-161-162
Agujas de sutura	120-121-122
Agujas para sutura	124
Agujas para tuberculina	192
Agujas VACUTAINER y VACUETTE	239
Ahuyentadores de conejos	45
Ahuyentadores de ciervos	45
Ahuyentadores de pájaros	45
Ahuyentadores de topos y ratones	45
Alargos recoge lechones	53
Alargos para sprays de marcar	63
Alargos para lápices de marcar	63
Alargo para empujador KAWE	86
Alargos para jeringas	168-171-174-177-182-184-187
Alcohol	115
Alfombras antiresbalante para salas de monta	235
Alfombra para desinfección	127
Alforja para inseminación artificial	234
Alimentador con separación de terneros azul de 5 tetinas	151
Anemómetro	31
Anillas nasales	139
Anillas para aves	78
Anillas para descolar	49
Antiestrés y salud animal	47
Anticanibalismo	46-50
Arcos para inseminación artificial porcina	234
Arnés de nailón para marcaje en ovino con pastillas RAIDEX	65
Arnés para prolapso ovino	110
Aspirador para pipetas azul, de 1 a 2ml	224
Aspirador para pipetas verde, de 2 a 10ml	224
Aplicadores de crotales	66-67-69-74-76-77
Aplicador ALLFLEX automático	76
Aplicador vaporizador nasal	188
Aturdidor eléctrico	41
Ayuda partos	109
B	
Bandeja para test de mamitis	153
Baños maría de acero inoxidable con termostato analógico	214
Baños maría de acero inoxidable con termostato digital	214
Baños maría de plástico con termostato analógico	215
Baños maría de plástico con termostato digital	215
Báscula de 1000kg con soporte pantalla	32
Báscula digital de 150kg, plataforma de 40x30cm	33
Báscula digital de bolsillo, 250g precisión 0,1g y 500g precisión 0,1g	33
Báscula digital para pesar animales hasta 20kg	33-200
Báscula electrónica acero inox estanca, 15kg precisión 1g	33
Báscula electrónica 2kg precisión 1g	33
Báscula electrónica 6kg precisión 1g	33
Báscula móvil digital de aluminio, 300kg	32
Báscula móvil digital de aluminio para pesar lechones en grupo, 1000kg	32
Básculas para pesaje de animales, pesaje 150Kg lectura 100g y pesaje 300Kg lectura 200g	33
Bastones metálicos para sujetar patas	142
Bastoncillos para las orejas	116
Barra para medición de vacuno HAUPTNER	142

Índice

Batas de tela desechables	90
Batas de plástico	90
Batas para partos	88
Bebederos	34 a la 38-116
Biberón	116-147-148-149-152
Bisturí	101-106-112
Bisturí eléctrico	101
Bola colgable especial para bienestar animal	47
Bolsas para pies	91
Bolsas para calostro	152
Bolsas para IA porcinos	228
Bombas dosificadoras	38
Bomba estomacal	145
Bomba peristáltica	221
Bombillas de infrarrojos	80-81
Bombillas de cuarzo	83
Botas desechables	91
Botas WELLINGTON superligeras	98
Botas WORKER EVA alta	98
Botas BEKINA	99
Botas DUNLOP	100
Bote para recogida de muestras	236
Botella para desinfección ambic, acción espumante	154
Botella para desinfección de pezones con retorno	154
Botella para desinfección de pezones sin retorno	154
Botellas biberón para corderos	147
Botellas de 1litro	223-236
Botella pulverizadora de pezones con alargó	154
Botellas de 750 ml con pulverizador	237
Botellas de vidrio	223
Botellas IA porcinos	228
Botellas Speedy drencher	152
Bozal grande para cerdas	47
Burdizos	52

C

Cabezadas	140
Cabezales protectores	113
Cabezales para esquiladoras OSTER A-5 y POWER PRO	129
CACACAN	116
Calentadores de leche	147
Calf drencher	152
Calostímetro	154
Cámaras de video para microscopios	210-211
Cámara recolectora conejos	200
Camisetas espaBITE	93
Campanas suizas con símbolos	157
Campanas suizas de acero color bronce	157
Campanas suizas de acero color cobre	157
Cánula bucal cono Luer Lock universal	190
Cánulas mamarias de 3,5cm	153
Cánulas mamarias BARTELS	153
Cánula mamaria cono Luer Lock	153
Cánulas mamarias Luer estériles	153
Cánula mamaria metálica cono Luer Lock redondo	153
Cánulas IA conejos	201
Cánulas postcervicales INSERBO con 4 salidas para la IA porcina	229-230
Cánulas postcervicales para la IA porcina	229-230-231
Cánulas Pour-on	188
Cánula tipo oliva	153
Carrete estéril catgut	119
Carrete estéril SUPRAMID	119
Carrete estéril SUPRAMID blanco	119
Carrete estéril de seda trenzada	119
Carretillas de poliéster	39
Carretillas de bajas	40
Carros de leche	147
Carro de limpieza y desinfección	126
Carro-mesa para la inseminación artificial porcina	235
Carros para tratamientos de lechones	53-174-175

Índice

Carro mesa para tratamientos de lechones, en acero inox	53
Cartuchos de humo	31
Cartuchos para pistola de sacrificio	41
Cascos de protección auditiva	93
Catéter FUERSTEMBERG	153
Catéteres intravenosos	164
Catéteres desechables antirreflujo para la IA porcina	230 a la 232
Catéteres de caucho nacional tipo melrouse	232
Catéteres desechables para la IA porcina	230 a la 233
Catéteres desechables tipo esponja	230-231-233
Catéteres desechables tipo esponja para nulíparas	233
Catéteres para lavados	155
Catgut	119
Cencerros de acero color bronce	157
Centrífugas	213
Cepillos para limpieza de animales	128
Cerbatana	195
Chaqueta para partos	88-98
Cierres vaginales	109
Cinta métrica para pesar ganado	142
Cinta nailon con velcro para vacuno	79
Cinta para sutura	119
Cinta velcro para lechones	47
Coladores de leche	151
Colector diluído	200
Colector de semen conejos de 5ml	200
Colorímetros	216
Colgador para botas	100
Collares de plástico para ovejas	79
Collares de plástico para vacuno	79
Collares con y sin cadena para vacas	140
Comederos para lechones	38
Comederos-bebederos para mascotas	116
Compresores de triquina.....	209
Conjunto impermeable	98
Contadores	142-216
Conectores para sondas endotraqueales	113
Correa para prolapsos de vacas	110
Corta colas eléctricos	50-51
Corta colas de gas	50
Corta colmillos	48-49
Cortador de pajuelas	155
Cortaorejas	114
Cortapezuñas	133
Cortaúñas para pequeños animales tipo guillotina	115
Crotales para marcar ganado.....	66 a la 76
Cubetas para llevar instrumentos	53
Cubetas para colorímetro	216
Cubo fun box colgante para bienestar animal	47
Cubos alimentadores de leche MILK Bar	150
Cubo para corderos con 6 tetinas	147
Cubo blanco de plástico para terneros	148
Cubo doble naranja con asa de 10L completo para terneros	149
Cubo terneros gris con tetina roja	148
Cubrepíes	90-91
Cuchillas para corta colas	50-51
Cuerdas para partos	109
Cureta cortante	111
Cúter para abrir botellas y tubos de inseminación artificial	234
Cutímetros	194
D	
Delantales para partos	88
Delantales para ordeño y limpieza	98
Depósito mezclador	38
Depósitos de 1 y 3 litros	169-191
Descalzador de botas	100
Descornadores	143-144
Descornador manual metálico BARNES	143
Descornador a baterías completo BUDDX	143

Índice

Descornador portátil recargable con carga de gas	143
Descornador eléctrico tipo revolver	144
Descornador eléctrico de 250W	144
Descongelador de pajuelas	155
Destetadores de aluminio	137
Destetadores de caucho	137
Destetadores de plástico con cierre de palomilla	137
Destetadores de plástico con muelle	137
Destetadores de plástico sin cierre	137
Destetadores metálicos para tenaza	137
Desinfectante INTRA multi-des ga	127
Desinfectante para ecógrafos y sondas	208
Detergente de laboratorio	225
Detectores de celo para vacuno HAUPTNER	208
Detectores de gestación	208
Detectores de metales	146
Detectores de humedad	29
Detectores de temperatura	29
Digestores	209
Dilatador de tetas Dr. NAYLOR	153
Diluyentes para semen conejos	200
Diluyentes para semen porcino	227
Dinamómetros	32
Disuasor de aves	45
Disco de metal	134
Disco abrasivo para pezuñas	134
Dosificadoras bucales	188-189-190
Dosificadores de jabón	94-101-225

E

Ecógrafos	204 a la 208
Elevadores para ganado vacuno	141
Emasculadores	52
Embriotomo completo HAUPTNER	110
Embudo de cristal	225
Embudo decantador de separación	209
Empujadores	85-86
Empujador eléctrico HAUPTNER	85
Empujador eléctrico TORERO	85
Empujador MAGIC SHOCK	86
Empujador MAGIC SHOCK corto	86
Empujador STARVET-SHOCK	86
Empujador KAWE 21 (por impulsos)	85
Envoltorio térmico para vagina de conejos	200
Equipo completo de diagnóstico GOWLLANDS Oto-oftal-larin	114
Equipos de infusión	164
Equipos de alimentación	164
Escalpelos LINDE	110
Esquiladoras	129 a la 132
Esquiladora OSTER A-5 de 1 y 2 velocidades	129
Esquiladora OSTER A-5 recargable, Power Pro	130
Esquiladora de baterías MOSER ARCO PRO	130
Esquiladora con batería de larga duración MOSER AVALON	130
Esquiladora recargable OSTER ARTISAN	130
Esquiladora OSTER PRO 3000i, de baterías	130
Esquiladora ANDIS ULTRAEDGE AGC SUPER, 2 velocidades	130
Esquiladora MOSER MAX 45, de dos velocidades	130
Esquiladora para ovejas HAUPTNER	131
Esquiladora para vacas HAUPTNER	131
Esquiladora para caballos HAUPTNER	131
Esquiladora para ovejas MASTER, de 300W	131
Esquiladora para vacuno RINDER, de 300W	131
Esquiladora para ovejas SHEARMASTER	131
Esquiladora para vacuno y perros grandes CLIPMASTER	131
Esquiladora manual para ovino	132
Esquiladora manual para vacuno	132
Esquiladora manual dos manos para ovino	132
Esquiladora manual dos manos para vacuno	132
Esquiladora manual minicorte estrecho	132
Esquiladora manual minicorte ancho	132

Índice

Estaciones raticidas	44
Esterilizador de catéteres	221
Esterilizador de rayos ultravioleta (UV)	213
Espéculo nasal y vaginal HARTMANN	108
Espéculo nasal y vaginal KILLIAN	108
Espéculos vaginales con mango de luz	108
Espéculo vaginal desechables	108
Espéculo vaginal POLANSKY	108
Espuma INTRA Foam Cleaner	126
Estabilizadores de corriente	220
Estereomicroscopios	212
Estrella antiestrés para porcino	47
Estuche de instrumental veterinario	106
Estufas para desecación y esterilización	213
Etiquetadora para dosis de semen	234
Evacuador de tetas sistema danés	153
Evacuador de tetas según HUG, cabeza cortante	153
Evacuador de tetas suizo	153
Exterminadores de insectos	42
F	
Fendona	42
Filtros para semen	227
Filtros para leche	151
Fishguard STARVET	168
Fonendoscopios	114
Fórceps de extracción dental	114
Fórceps obstétrico	108
G	
Gafas de protección	92
Gancho obstétrico	110
Gancho bucal para dosificadora	188
Gas para corta colas	50
Gel de ecógrafo	208
Gel de exploración	156
Gel INTRA Hoot-fit	136
Gel lubricante	156-234
Gel solución hidroalcohólica SERBONET	94-101
Gomas para descolar	49
Gorro desechable	89-90
Goterros	164
Gradillas inox para selladoras de tubos	221
Gradillas para tubos de hasta \varnothing 16mm / \varnothing 17mm / \varnothing 30mm	238
Grapadora de sutura precargada con 35 grapas (estéril)	116-119
Grapas para morro de cerdo	139
Grasa para ubres de vacas EUTRA	154
Guantes de Látex	94-227
Guantes de Nitrilo	94-95
Guantes de Plástico	94-96-227
Guantes de Vinilo	94
Guantes de inseminación artificial	96-97-156
Guantes obstétricos	49-97
Guía para lazo corredizo	109
H	
Higrómetros	30
Hisopos estériles para recogida de muestras	108-238
I	
Indicador de PH	31
Inseminación Artificial para conejo	198 a la 201
Inseminación Artificial para porcino	225 a la 235
Inseminación Artificial para vacuno	155-156
INTRA DERMA	115
INTRA Foam Cleaner	126
INTRA Hoof-fit	135
INTRA Hoof-fit BATH	135
INTRA Multi-Des GA	127
INTRA Repiderma-Microderm	50-136
Introducidos de imanes esofágicos (rígidos y flexibles)	146

Índice

Inyectores de 0,25 / 0,50 / universales	155
Imanes esofágico blanco	146
Imanes esofágicos STARVET, forma de jaula	146
Imanes para planing	72
Imperdible vaginal	109
Introdutores de imanes	146
J	
Jarra de plástico	39-151-224
Jeringas completas con cánula recte para I.A. conejos	198
Jeringas desechables	162-163
Jeringas de tuberculina	192-193
Jeringas dosificadoras bucales	188-189-190
Jeringas ECO-MATIC	186
Jeringas FERROMATIC	186
Jeringas GROTEERMAN	193-198-199
Jeringas HAUPTNER	180 hasta la 183
Jeringas intradérmicas sin aguja	173-184-193-198-199
Jeringas neumáticas	172 a la 175
Jeringas ROUX	184
Jeringas SERENA	187
Jeringas STARVET lisas y graduables.....	165
Jeringas STARVET de 1 metro para la vacunación a distancia	165
Jeringas SOCOREX.....	176 a la 179
Jeringas tipo revolver	180 a la 184
Jeringas vacunadoras	166 a la 187
Jeringas vacunadoras STARVET	166 a la 171
Jeringas vacunadoras STARVET a baterías	171
Jeringas VET-MATIC	186
Juego de abre bocas	114
Juego de números de aluminio	64
Juego de números de bronce	64
Juego de números para nitrógeno HAUPTNER	64
K	
Kit desechable (2 cubrepiés, bata, gorro y mascarilla)	90
Kit de ordeño manual para ovino-caprino	151
Kit 10 bolsas calostro + tetina + sonda	152
Kit de recogida de fluidos orales para cerdos	238
Kit de rumenotomía completo	112
Kit completo para autopsias	112
Kits reactivos cloro	31
L	
Lámparas de quirófano de pie y de techo	113
Lámparas protectoras de bombillas de infrarrojos	81
Lanza limpiadora-aspiradora SPEEDY para limpiar bebederos y comederos	126
Lápices para marcaje de carne	64
Lápices para marcar ganado INSERFIX	63
Lápices para marcar ganado RAIDEX	62
Lápiz cauterizador para descornar	144
Lazos para coger cerdos	84
Lector ALLFLEX Global Scan GS110	77
Lector ALLFLEX RS420	77
Legra para pezuñas	134
Legra derecha de corte doble (dorso cortante)	134
Legra izquierda de corte doble	134
Legra de corte izquierdo	134
Legra derecha de corte doble (hoja total)	134
Letras para tauadoras y martillos de tatuar	54 a la 61
Levamis Nucleos	235
Limas dentales	48
Lima a pilas para uñas de perros	115
Lima para cascos	136
Limpiador con esquineras	125
Limpiador recto	125
Limpiador tipo circular	125
Limpiadores de calzado para entrada en granjas	128
M	
Mango limpiador	125
Manguitos de poliéster	94

Índice

Máquina para llenado de dosis seminales de conejo	201
Marcas ALLFLEX botón hembra	74
Marcas ALLFLEX botón hembra electrónico	76
Marcas ALLFLEX botón macho	74
Marcas ALLFLEX botón macho cuello largo	74
Marcas ALLFLEX botón macho júnior	75
Marcas ALLFLEX pala hembra maxi	75
Marcas ALLFLEX pala hembra mediana	74
Marcas ALLFLEX pala hembra júnior	75
Marcas ALLFLEX pala hembra Pentag	76
Marcas ALLFLEX pala hembra sénior	76
Marcas ALLFLEX pala macho mediana	74
Marcas ALLFLEX pala macho Pentag	75
Marcas ALLFLEX pala macho sénior	76
Marcas ALLFLEX kit TST para muestras de tejidos BOT+BOT	77
Marcas Dorital HAUPTNER	66
Marcas metálicas numeradas para conejos	67
Marcas Durafix HAUPTNER	67
Marcas INSERFIX botón hembra	69
Marcas INSERFIX botón hembra cerrada	71
Marcas INSERFIX botón macho con punta de metal	69
Marcas INSERFIX botón macho con punta de metal "cuello largo"	69
Marcas INSERFIX botón macho con punta de plástico	69
Marcas INSERFIX mini	67
Marcas INSERFIX pala hembra grande	68
Marcas INSERFIX pala hembra grande cerrada	71
Marcas INSERFIX pala hembra mini	71
Marcas INSERFIX pala hembra júnior	70
Marcas INSERFIX pala hembra mediana cerrada	71
Marcas INSERFIX pala hembra pequeña cerrada	71
Marcas INSERFIX pala hembra mini cerrada	71
Marcas INSERFIX pala hembra maxi	68
Marcas INSERFIX pala hembra pequeña	68
Marcas INSERFIX pala macho grande	68
Marcas INSERFIX pala macho júnior	70
Marcas INSERFIX pala macho mini	71
Marcas INSERFIX pala macho pequeña	68
Marcas INSERFIX pala macho sénior	70
Marcas INSERFIX para colgar	72
Martillo para autopsias	111
Martillo para autopsias LUCAE	111
Martillo para herrajes de pezuñas con cabeza reforzada	133
Martillo percutor TAYLOR	106
Martillo percutor TRÖMMER	106
Martillo tatuador INSERFIX con depósito incorporado de tinta	60-61
Martillos tatuadores	54-60-61
Mascarillas	90-92
Medidor de cloro y dióxido de cloro.....	31
Medidor de calostro (calostímetro)	154
Medidor de grasa LEAN METER	208
Medidor de grasa con lector de chips INSERBO	208
Medidor de humedad para grano	240
Medidor de humedad para paja y heno	240
Medidor de temperatura para grano	240
Mesa de quirófano	113
Microscopios	210-211
Microtubos EPPENDORF 1,5ml	238
Mochila tanque de aire	175
Mono impermeable para lavado y limpieza	98
Mono para partos	88
Monos desechables	89
MONOVETTE L suero de 9 ml	237
Multiplicador de presión para tanques	174
N	
Narigueras	138
Neveras de dobles puertas pasantes para la bioseguridad en granjas y centros I.A.	217
Neveras de transporte con compresor	220
Neveras de transporte con celula Peltier y bolsa nevera	220
Neveras fijas de 70 hasta 600L de capacidad	217 a la 219

Índice

Nebulizadores para vacunas TURBAIR	195
Números para tatuadoras y martillos de tatuar	54-55-57-61
O	
Otoscopio GOWLLANDS	114
Otoscopio-Oftalmoscopio GOWLLANDS	114
P	
Pajuelas de 0,25	155
Pajuelas de 0,50	155
Palas arreadoras para empujar ganado	85
Palas dispensadoras de pienso	39
Pala dispensadora con báscula	39
Pala-jarra dispensadora para sólidos y líquidos	39
Pantalón para partos	88
Pantalón desechable	91
Paños de limpieza para ubres	154
Papel indicador mamicis	153
Pasta para descornar en jeringa dosificadora	144
Pastillas RAIDEX para arnés	65
Pediluvio acero inox con bandeja-muelles	127
Pediluvio acero inox doble con bandeja-muelles	127
Pediluvio de desinfección	127
Pediluvio de desinfección caucho	127
Pediluvio INTRA BATH doble 2 partes más gradilla inox	135
Pediluvio super-kombi para cascos	128-135
Pelotas antiestrés para porcino	47
Phmetros portátiles	31
Pinza ADSON	107
Pinza-Alargo recoge lechones tipo revólver de 80cm	53
Pinza ALLIS	106
Pinza aturdidora para ovejas	41
Pinza BACKHAUS	106
Pinza campo cangrejo SCHAEDEL	106
Pinza CRILE	105
Pinza de disección	107
Pinza de sujeción para termómetros baño maría	27
Pinza extractora de grapas	116-119
Pinza intestinal	105
Pinza KOCHER	104
Pinza mosquito	105
Pinzas umbilicales	48
Pinza para sujetar patas	141
Pinza para sujetar colas	142
Pinza para espinas FELCHENFELT	107
Pinza para extracción de garrapas	116-119
Pinza para oído, según LUCAE	107
Pinza para panza BLENDING	107
Pinza para útero cabeza goma	107
Pinza PEAN	105
Pinza tipo cocodrilo HARTMANN	106
Pinza tira lenguas COLLING	107
Pipetas aforadas	224
Pipetas automáticas fijas	224
Pipetas automáticas graduables	224
Pipetas graduadas	224
Pipetas Pasteur de plástico	224
Pipetas Pasteur de plástico graduadas	224
Pipetas Pasteur de vidrio cortas	224
Pipetas Pasteur de vidrio largas	224
Pipeta para conteo de semen conejo	200
Pistola de espuma dosificable, con depósito de 2l	126
Pistola para extracción de grasa	208
Pistolas para sacrificio de animales	41
Pistolas para sacrificio de conejos	41
Pistolas para spray de marcar	63
Placas calentable para microscopio	215
Placa de Petri 55x14mm	236
Planning para control de granjas	72

Índice

Plantillas BEKINA	99
Potro de castración de lechones tipo asiento	53
Potro de castración de lechones standard	53
Potros para castración acero inox, con soporte	53
Potro para monta fijo y móvil con apoyo	235
PORKIREP Spray tranquilizante de cerdos	46-50
Portagujas OLSEN-HEGAR con tijera	123
Portagujas GUILLES con tijera	123
Portagujas MATHIEU	123
Portagujas MAYO	123
Portalámparas para bombillas de cuarzo	83
Portalámparas para bombillas de infrarrojos	81
Portarrollos de papel	154-235
Povidona yodada Desinpov de 500ml	115
Precintos de plástico	78
Psicrómetros para medir humedad	30
Pulseras de plástico para identificación de vacunos	79
Puntas micropipetas amarillas de 5 a 200ml	224
Puntas micropipetas azules de 100 a 1000ml	224
Puntas para limas dentales	48
Protector de hombros	88

R

Raspador dental para perros (varios medidas)	115
Raqueta eléctrica matamoscas	42
Raticidas	44
Reactivo para test de California	153
Reflectores de cuarzo	82
Rollo de papel para limpieza de ubres	154
Rotulador ALLFLEX Tag-Pen	72
Rotulador para marcas INSERTIFIX	67-72
R.U.M. Spray tranquilizante	46

S

Sacos negros grandes gruesos	40
Seda trenzada	118-119
Selladoras para el envasado de tubos IA	221
Separador de leche QUARTER MILKER	147
Separador FARABEUF	111
Separador VOLKMAAN	111
Separador WEITLANER	111
Serrucho para autopsias	111
Sierra para autopsias	111
Sillas de ordeño con asiento de plástico o de madera y cinta de sujeción	154
Sirgas para cuernos y mangos para sirgas de descornar	143
Sonda acanalada	106
Sonda de recambio Waterproof para FUTURE-2	207
Sonda esofágica	145
Sondas endotraqueales	113
Sonda multifrecuencial FUTURE-1	205
Sonda nasogástrica	145
Sonda para calostro de lechones y lechales	152
Sonda para FUTURE Wifi	206
SPLAYLEGSTOP para lechones	47
Spray INTRA DERMA de 100ml	115
Spray para detectar celo en cerdas	234
Spray para marcar ganado INSERTIFIX y RAIDEX	62-63
Spray desinfectante	101-208
STERIMATIC kit completo	160
SUPRAMID	118

T

Tableros para arrear ganado INSERTIFIX	85
Tablet con pantalla de 7" waterproof IP-68 y antigolpes	205
Tapas para baños maría inox	214
Tapones para oídos 3M	93
Tampón para martillo tatuador INSERTIFIX	61
Tampón para tinta de números manuales	59
Tarros de boca ancha con tapa y obturador	236
Tatuadoras	55-56

Índice

Tatuadoras articuladas	56
Tatuadoras rotativas	56
Tenaza ALLFLEX	74-76
Tenaza ALLFLEX aplicadora TST muestras de tejidos	77
Tenazas corta colmillos	49
Tenaza HAUPTNER para ágrafes de sutura	109-119-139
Tenaza grapas para morro de cerdo universal	139
Tenaza para anilla nasal de vacuno	139
Tenaza para anilla nasal de cerdo	139
Tenaza para ágrafes de sutura y grapas morro	139
Tenaza para ágrafes y grapas HAUPTNER	139
Tenaza para cascos, con dientes	133
Tenaza para colocar destetadores metálicos	137
Tenaza para crotales universal	77
Tenazas para gomas descolar	49
Tenaza para marcas de conejos	67
Tenaza para marcas INSERFIX	69
Tenaza para marcas INSERFIX con aguja basculante	76
Tenaza para marcas INSERFIX mini	67
Tenaza remachadora para pezuñas	133
Tenazas sacabocados	66
Termómetros ambiente	27
Termómetro avicultura	27
Termómetros con conexión a ordenador	29
Termómetros con lanza	30
Termómetros de máxima y mínima	27-30
Termómetros de veterinaria con y sin anilla	28
Termómetros de veterinaria digitales	28
Termómetro de veterinaria punta flexible	28
Termómetro de veterinaria extragrande	28
Termómetro de veterinaria digital ACCUVET	28
Termómetros de infrarrojos	29
Termómetros digitales con sonda exterior	30
Termómetros digitales con sonda interior	30
Termómetros para líquidos	27
Tetina para pequeños animales	116
Tetina de recambio para corderos de caucho calidad extra	147
Tetina de recambio para biberón de corderos	147
Tetina de recambio roja para botella biberón de cordero	147
Tetina terneros de caucho calidad extra para cubo	148
Tetina terneros para cubo negro	148
Tetina terneros de caucho calidad extra para cubo verde	148
Tetina terneros de caucho extra para botella	148
Tetina de recambio roja, botella biberón terneros	148
Tetina flotante para terneros	149
Tetina para botella biberón de terneros	149
Tetina para cubo doble naranja	149
Tetina de terneros negra MILK Bar	150
Tijeras costauñas para gatos	115
Tijeras costauñas para perros	115
Tijeras IRIS	103
Tijeras JESCO	103
Tijeras LISTER	103
Tijeras LITTAUER para quitar puntos	103
Tijeras MAYO-STILLE	103
Tijeras METZENBAUM	103
Tijera para esquilar	132
Tijera para cascos	134
Tijera para cascos dentada	134
Tijera para cascos reforzada FELCO, mango rotativo	134
Tijera para cascos-pezuñas reforzada FELCO	134
Tijeras rectas y curvas	102
Tijeras SPENCER para quitar puntos	103
Tinta de tatuar alimentaria	59
Tinta de tatuar carne decomisada	59
Tinta de tatuar en frasco	58
Tinta de tatuar líquida	61
Tinta para marcar ovejas	65
Tinta sistema bola	58

Índice

Tiras indicadoras de peróxido, dióxido de cloro y cloro	31
Tiza para marcaje Sisa RAIDEX	64
Toallitas "Biodegradables" para higiene de cerdas, no espermicidas	228
Toallitas desinfectantes para higiene de cerdas, no espermicidas	228
Toallitas desinfectantes para instrumental	101
Toallitas desinfectantes para ubres	154
Traba evitacoces	141
Trampas para cucarachas	42
Trampas para moscas	42
Trampas para ratas	43
Trampas para ratones	43
Tranquilizante de cerdos	46-50
Tranquilizante de usos múltiples	46
Transformadores 220v-12v para neveras de transporte	220
Triquinoscopios de pantalla	209
Trocar de tornillo, material plástico	145
Trocar HAUPTNER con dos cánulas	145
Trocar mango de madera	145
Trocar mango de metal	145
Trocar universal metálico	145
Tubo de silicona de 1m	169
Tubo presuero de 5ml	237
Tubos para muestras	237-238
Tubos soldables extrafinos para dosis de semen INSERBO	228
Tubos VACUTAINER con EDTA de 4ml	239
Tubos VACUTAINER de 5ml	239
Tubos VACUETTE plástico de 4,5ml	239
U	
Ungüento para ubres de vacas	154
V	
Vacunador de garrocha	195
Vacunadoras METÁLICAS	181-182
Vacunadoras SOCOREX	176 a la 179
Vacunadoras STARVET	166 a la 171-198
Vainas	155
Válvula de aluminio para tetina corderos	147
Válvula de plástico para tetina corderos	147
Válvula completa de recambio para cubo de plástico para terneros	148
Vagina artificial conejos	200
Vagina artificial de silicona para conejos	200
Vagonetas para pienso de poliéster	39
Varilla recoge imanes	216
Vaselina líquida de 1L	234
Vendas de alquitrán	116
Vendas de gasa	116
Vendas cohesivas	116
Vendas cohesivas INSERFIX	117
Vendas elásticas adhesivas	116
Venda sintética poliéster blanca	116
Vestuario	88 a la 93
Vídeo-endoscopio-otoscopio completo con tres cámaras de vídeo	114
Vídeo gafas para ecógrafo FUTURE-1	205
Vidrio científico	222 a la 225

Index

A

A.I buddy for gilts (yellow)	234
A.I buddy for SOWS (green)	234
Alcohol 70° bottle 1L	115
ALLFLEX Global Scan GS110 reader	77
ALLFLEX RS420 reader	77
ALLFLEX tissue sampling TST tag applicator	77
Analog counter	142
Anemometers	31
Animal welfare, hanging fun box cube	47
Animal welfare, special hanging ball	47
Anticanibalism spray	50
Anti-kick bar	141
Anti-stress ball for pigs	47
Anti-stress star for pigs	47
Applicator, for rubber rings	49
Applicator, HAUPTNER suture wire ring	109
Applicator, for rubber rings, plastic	49
Applicators for ear tags	66-67-69-74-76-77
Apron, milking and washing	98
Artificial insemination for cattle	155-156
Artificial insemination for pigs	225 to 233
Artificial insemination for rabbits	198 to 201
Autopsy kit	112

B

Bags, big thick blacks	91
Bags, black plastic for shoes	91
Bags, for semen	228
Blood collection set, butterfly type	164
Bandages, cohesive	116-117
Bandages, elastic adhesives	116
Bandages, INSERFIX cohesive	117
Bandages, gauze	116
Bandages, KROMBERG tar	116
Bandages, white polyester synthetic	116
Beakers	223
Bell, Swiss, steel bronze colour	157
Bell, Swiss with drawing	157
Bell, Steel, brass colour	157
Bird rings with clip	78
Blowpipe, complete	195
Boots, BEKINA and DUNLOP	99-100
Boots, light (-30°C)	98
Boots, super light safety S4 (-30°C)	98
Boot holder stainless steel for 4 pairs of boots, inclined model	100
Boot remover	100
Bottles for dose of semen	228
Box to transport utensils in livestock	53
Braided silk	118
Braided silk cassette (sterile)	119
Brush to clean glass material	225
Brushes with spring for animals cleaning	128
Brushes with spring and tank for animals cleaning	128
Bulbs, hard glass INSERBO infrared, clear	80
Bulbs, hard glass INSERBO infrared, red	80
Bulbs, hard glass PHILIPS infrared, clear	81
Bulbs, hard glass PHILIPS infrared, red	81
Bulbs, INSERBO infrared, clear	80
Bulbs, INSERBO infrared, red	80
Bulbs, INSERBO red quartz	83
Bulbs, INSERBO quartz	83
Bulbs, INTERHEAT infrared, clear	81
Bulbs, INTERHEAT infrared, red	81
Bulbs, PHILIPS infrared, red	81
Bull holder (EISENHUT)	138
Bull holder (HARMS)	138
Bull holder with handle	138
Bull holder with spring	138
Bürker chambers	225

Index

C

CACACAN, box of 25 units	116
Caffeine (pure)	222
Calf bucket holder	148
Calf drencher profi with flexible probe 105 cm	152
Calf drencher with flexible and rigid probe	152
Calf feed bucket with and without teat	148
Calf feed bucket, double orange	149
Calf feeding milk bottles	148
Calf feeding grey bucket with red teat and valve	148
Calf teat floating	149
Calf teats for black bucket	149
Calf teats for double bucket	149
Calf teats for green bucket, extra quality rubber	148
Calf teats for green bucket, extra quality rubber, for bottle	148
Calf teats, for feeding bottle	148
Calf teats, for MILK BAR black	150
Calf teats, red for milk bottle	148
Calf teats, red for grey and green bucket	148
Calf rubber teat for bucket	148
Calliper, analog for tuberculin test	194
Calliper, analog for tuberculin test with spring	194
Calliper, analog for tuberculin test with spring for left-handed	194
Calliper, HAUPTNER gun type analog and digital for tuberculin test	194
Calliper, with watch for tuberculin test	194
Cannula, disposable curved and straight for rabbits artificial insemination	201
Cannula, glass curved for rabbits artificial insemination	201
Cannula, intra-uterine with and without catheter	229-230-231
Cap, disposable	89
Cartridges, smoke	31
Cartridges for animal slaughter gun	41
Castrators	52-53
Castrating tables for piglets	53
Catgut, sterile cassette	119
Catheter, spiral and foam type disposables	230 to 233
Catheter, Melrouse type national rubber	232
Cattle heat detector, HAUPTNER	208
Cattle hobble adjustable	141
Cattle hobble standard	141
Cattle labour's help	109
Centrifuges	213
Claw, revolver-type for piglets	53
Cleaning and disinfection trolley	126
Cleaning spray for clipper heads	130
Cleaning vacuum lance to clean drinkers and feeders, SPEEDY	126
Clippers	129 to 132
Clipper, ANDIS ULTRAEDGE AGC SUPER 2 speeds	132
Clipper, CLIPMASTER for cattle and big dogs	131
Clipper heads, for OSTER A5 and POWER PRO	129
Clipper heads, TAILWELL 2 cattle tail	131
Clipper, OSTER ARTISAN rechargeable	130
Clipper, OSTER A5	129
Clipper, OSTER A5, rechargeable, Power Pro	130
Clipper, OSTER PRO 3000i battery	130
Clipper, MASTER sheep	131
Clipper, MOSER ARCO PRO battery	130
Clipper, MOSER AVALON with long lasting battery	130
Clipper, MOSER MAX 45 2 speeds	130
Clipper, HAUPTNER for cattle	131
Clipper, HAUPTNER for horse	131
Clipper, HAUPTNER for sheep	131
Clipper, hand, narrow cutting	132
Clipper, hand, wide cutting	132
Clipper, hand for sheep and for cattle	132
Clipper, two hand for sheep and for cattle	132
Clipper, RINDER for cattle	131
Clipper, SHEARMASTER for sheep	131
Coat, disposable cloth with pocket for visits	90
Coat, disposable green closed plastic	90

Index

Coat, disposable plastic closed	90
Coat, disposable plastic with buttons	90
Coaxer, HAUPTNER	85
Coaxer, MAGIC SHOCK blue	86
Coaxer, MAGIC SHOCK short	86
Coaxer, STARVET-SHOCK	86
Coaxer, TORERO	85
Coaxer, KAWE	85
Coaxer, KAWE 21	85
Colostrum bags, kit 10 colostrum bags + teat + probe	152
Colostrum scale	154
Colostrum probe for piglets and calves	152
Colorant for semen (non-spermicidal)	227
Colorimeters	216
Compressors for trichina	209
Container, 3L STARVET complete	169
Container, 3L STARVET flat transparent	169
Container, 3L STARVET transparent	169
Cow lifter	141
Curette, VOLKMANN cutting	111
Curette, VOLKMANN double cutting	111
D	
Dehorner paste in dosing syringe	144
Dehorning, BARNES metal	143
Dehorning caustic pen	144
Dehorning, complete battery	143
Dehorning, electric 250w	144
Dehorning, electric pistol handle	144
Dehorning, portable, rechargeable with gas cartridge	143
Dehorning saw wire	143
Dehorning, saw wire handle	143
Dehorning tips	144
Dental scaler for dogs (several sizes)	115
Detector, USB temperature and humidity	29
Detector, temperature	29
Detector, metal	146
Detector, gestation	208
Detector, HAUPTNER for cattle heat	208
Digestors for meat analysis	209
Disinfectant cleaner for shoes	128
Disinfectant rug	127
Dispenser, automatic infrared soap and gel	94-101-225
Dispenser, manual soap	94-225
Dispensing shovels	39
Dispensing shovels with built-in scale	39
Drainers	223
Drinkers	34 to 38
Dynamometers	32
E	
Ear notcher for dogs	114
Ear notcher HAUPTNER	66
Ear notcher, nickel-plated	66
Ear plugs, 3M banded	93
Ear plugs, 3M ultrafit corded	93
Ear tags applicators, ALLFLEX and ALLFLEX automatic	74-76-77
Ear tags applicator, for rabbits	67
Ear tags applicators, HAUPTNER Dorital	66
Ear tags applicators, INSERFIX	67-69-76-77
Ear tags applicators, INSERFIX with tilting needle	76
Ear tags applicators, for mini INSERFIX ear tags	67
Ear tags applicators, universal	77
Ear tags, ALLFLEX, female and male, shovel form	76
Ear tags, ALLFLEX medium, female and male, shovel form	74
Ear tags, ALLFLEX round female and male	74
Ear tags, ALLFLEX round male, long neck	74
Ear tags, ALLFLEX round female, FDX electronic	76
Ear tags, ALLFLEX kit for tissue sampling BOT+BOT	77

Index

Ear tags, junior ALLFLEX, female and male, shovel form	75
Ear tags, maxi ALLFLEX, female, shovel form	75
Ear tags, HAUPTNER Dorital	66
Ear tags, HAUPTNER Durafix	67
Ear tags, HAUPTNER Supercrotal	66
Ear tags, INSERTIFIX close button female	71
Ear tags, big INSERTIFIX, female and male, shovel form	68
Ear tags, junior INSERTIFIX, female and male, shovel form	70
Ear tags, INSERTIFIX, female, button form	69
Ear tags, INSERTIFIX, male, button form with metallic point	69
Ear tags, INSERTIFIX, male, button form with plastic point	69
Ear tags, INSERTIFIX big female, shovel form, closed model	71
Ear tags, INSERTIFIX medium, female, shovel form, closed model	71
Ear tags, senior ALLFLEX, female and male, shovel form	76
Ear tags, maxi INSERTIFIX, female, shovel form	68
Ear tags, mini INSERTIFIX	71
Ear tags, senior INSERTIFIX, female and male, shovel form	70
Ear tags, small INSERTIFIX, female and male, shovel form	71
Ear tags, small INSERTIFIX, female, shovel form, closed model	71
Electrosurgery	101
Emasculator, HAUSSMAN	52
Emasculator, REIMERS for horse	52
Emasculator, VERBOCZY for horse	52
Emasculator, SERRA	52
Embriotome, complete HAUPTNER	110
Endotracheal probes with olive-tip	113
Eosine	222
Erlenmeyer	222
ESPABITE Tshirts	93
EUTRA milking fat	154
EUTRERGEL for cow udders	154
Exploration gel, BOVI-VET	156
Extender, for pigs A.I.	227
Extender, for rabbits A.I.	200
Extension for marking sprays (INSERTIFIX)	63
Extensions for marking sticks	63
Exterminators, electronic for insect	42

F

Fat extraction pistol	208
Fat meters	208
Feeders bucket, Milk Bar	150
Feeders, for piglets	38
Feeders-drinkers for pets	116
Feeding bottle for small animals	116
Feeding bottle 250ml with probe for colostrum lambs	152
Feeding bucket for lambs	147
Feeding infusion set with bag	164
Forceps, ADSON dissection	107
Foam gun	126
Footbath, disinfection	127
Footbath, double stainless steel with tray-springs	127
Footbath, rubber disinfection	127
Footbath, stainless steel with tray-springs	127
Footbath, Super-kombi for hoofs	128
Footbath double 2 parts plus stainless steel dack (INTRA BATH)	135
Forceps, ALLIS	106
Forceps, BACKHAUS	106
Forceps, BLENDING for paunch	107
Forceps, COLLING tongue	107
Forceps, CRILE	105
Forceps, Dissection	107
Forceps, elbow ear	107
Forceps, FENCHENFELT splinter	107
Forceps, for uterus with rubber top	107
Forceps, HARTMANN crocodile	106
Forceps, intestinal	105
Forceps, mosquito	105
Forceps, KOCHER	104
Forceps, LUCAE ear	107

Index

Forceps, obstetric danish model	108
Forceps, obstetric WITT	108
Forceps, PEAN	105
Forceps, SCHAEDEL towel clamp	106
Forceps, tooth extraction	114
Formaldehyde	225
G	
Gas for tail docker	50
Gerlach needle	124
Gestation detector, PREG-TONE	208
Glass funnel	225
Gloves, 85cm elastic supersensitive	97
Gloves, 90cm sensitive	96
Gloves, 90cm sensitive (GLOVET)	97
Gloves, 90cm sensitive with neck lace	97
Gloves, 90cm supersensitive	96
Gloves, 90cm orange sensitive	96
Gloves, 90cm pig obstetric	97
Gloves, disposable plastic, special width	94
Gloves for shoulder and armpit protection (NECK)	97
Gloves, STARVET powder free and with powder latex	94
Gloves, orange rough nitrile	95
Gloves, PEHA-SOFT nitrile	94
Gloves, powder free black nitrile	95
Gloves, powder free nitrile	95
Gloves, STARVET powder free vinyl	94
Gloves, STARVET with powder vinyl	94
Gloves, supersensitive for shoulder and armpit protection	97
Gloves with elastic band	96
Grooved director	106
Guns for animals slaughter	41
Guns for piglets slaughter	41
Guns for rabbits slaughter	41
H	
Halter for calves, nylon	140
Halter for calves and cows	140
Halter for cows	140
Halter for cows with chain	140
Hammer, autopsy LUCAE metallic handle	111
Hammer, autopsy wooden handle	111
Hammer, heavy duty shoeing	133
Hammer, TAYLOR striker	106
Hammer, TRÖMMER striker	106
Harness for sheep marking with RAIDEX wax blocks (in nylon)	65
Harness for sheep prolapse	110
Hearing protection helmets with Protac III voice hearing, 3M	93
Hearing protection helmets, 3M Peltor Optime	93
Heatable plates, INSERBO	215
Hoof cutter, articulated	133
Hoof cutter, lateral cutting	133
Hoof cutter, non serrated	134
Hoof cutter, serrated	134
Hoof file	136
Hoof knife	134
Hoof knife, left hand, double sided cutting, wooden handle	134
Hoof knife, left hand, wooden handle	134
Hoof knife, righthand, all blade cutting, wooden handle	134
Hoof knife, righthand, double sided cutting, wooden handle	134
Hoof knife, righthand, wooden handle	134
Hoof nail clinch, 35cm	133
Hoof plier, with teeth	133
Hoof scissors, FELCO	134
Hoof scissors, FELCO, rotative	134
Hydroalcoholic solution gel, SERBONET	94-101
Hygrometers and hygrothermometers	30
I	
Immersion oil	222

Index

<i>Indicators strips, Peroxide, Chlorine Peroxide and Chloride</i>	31
<i>Indicators, PH</i>	31
<i>Indicators, mastitis</i>	153
<i>Infusion set, disposable</i>	164
<i>Infusion set, Luer Lock two way</i>	164
<i>Infusion set reusable Luer cone with needle</i>	164
<i>Infusion set, Y Luer Lock double line dropper type</i>	164
<i>Injector, 0,25</i>	155
<i>Injector, 0,50</i>	155
<i>Injector, universal</i>	155
<i>Insole, BEKINA standard</i>	99
<i>Insole, BEKINA ergonomic and inmpact protection</i>	99
<i>INTRA BATH footbath double 2 parts plus stainless steel rack</i>	135
<i>INTRA DERMA</i>	115
<i>INTRA Foam Cleaner</i>	126
<i>INTRA Hoof-fit</i>	135
<i>INTRA Hoof-fit BATH</i>	135
<i>INTRA Microderm</i>	136
<i>INTRA Multi-Des GA</i>	127
<i>INTRA Repiderma-Microderm</i>	50

J

<i>Jar for milk, plastic</i>	151
<i>Jangle, steel, bronze colour</i>	157

L

<i>Labelling machine for semen samples</i>	234
<i>Laboratory detergent GLASSGEN</i>	225
<i>Lamb feeding bottle</i>	147
<i>Lamb spare teat</i>	147
<i>Lamp, ceiling for operating room</i>	113
<i>Lamp, free standing for operating room</i>	113
<i>Lamp holder, for infrared bulbs</i>	81
<i>Lamp-holder for quartz bulbs</i>	83
<i>LEVAMIX</i>	235
<i>Leg and neck metallic crook</i>	142
<i>Leg metallic crook</i>	142
<i>Lubricant coolant spray for clippers</i>	130
<i>Lubricant gel-gynecologist disinfectant</i>	156
<i>Lubricant gel, RAIDEX</i>	156

M

<i>Magnetic stirrers</i>	216
<i>Markers for ear tags</i>	67-72
<i>Marking sprays applicator</i>	63
<i>Marking sprays, INSERFIX</i>	63
<i>Marking sprays, RAIDEX</i>	62
<i>Marking sprays, RAIDEX sheep marking</i>	62
<i>Marking sticks, INSERFIX</i>	63
<i>Marking sticks, RAIDEX</i>	62
<i>Mask, disposable surgical with additional reinforcement</i>	90
<i>Mask, for gases and vapors (3M)</i>	92
<i>Mask, for gases and vapors especially ammonia (3M)</i>	92
<i>Mask, DRÄGER FFP3 with valve</i>	90
<i>Mask, DRÄGER FFP1 with filter</i>	90
<i>Mask, DRÄGER FFP2</i>	90
<i>Mask, DRÄGER FFP2 and FFP3 with valve</i>	90
<i>Mask, FFP1 foldable with valve (3M)</i>	92
<i>Mask, FFP1 and FFP2 with valve (3M)</i>	92
<i>Mask, surgical type IIR</i>	90
<i>Mastitis indicator paper</i>	153
<i>Mating table, wood lined, fixed and mobile with support</i>	235
<i>Measuring sticks, HAUPTNER</i>	142
<i>Metal detector</i>	146
<i>Microscopes</i>	210-211
<i>Microscopes with phase contrast kit</i>	210
<i>Milk filter socks stitched</i>	151
<i>Milk filter Ø 200 mm</i>	151
<i>Milk sucking preventor, metallic and aluminium</i>	137
<i>Milk sucking preventor, metallic applicator</i>	137
<i>Milk sucking preventor, plastic with butterfly adjustment nut</i>	137

Index

<i>Milk sucking preventor, plastic with spring</i>	137
<i>Milk sucking preventor, rubber</i>	137
<i>Milk sucking preventor, yellow plastic without lock</i>	137
<i>Milk strainer, aluminium</i>	151
<i>Milk strainer spare filter set</i>	151
<i>Milk trolley stainless steel with pump, mixer and pasteuriser</i>	147
<i>Milk trolley with pump and mixer</i>	147
<i>Milk warmer, electric 2.300w</i>	147
<i>Milk warmer, electric 2.300w with digital display</i>	147
<i>Milking chair with plastic seat and fastening tape</i>	154
<i>Milking chair with wooden seat and fastening tape</i>	154
<i>Mouth gag</i>	114
<i>Mouth gag for probangs</i>	145
<i>Mouth gag, SMITH-BAXTER kit</i>	114
<i>Mouth gag, Schulze metal for cattle and horse</i>	141
<i>Muzzle, big for sows</i>	47

N

<i>Nail clipper for cats and dogs</i>	115
<i>Nail cutter for small animals with guillotine action</i>	115
<i>Nail trimmer for dogs (battery powered)</i>	115
<i>Nasal-gastric probes</i>	145
<i>Necklace with chain for cows</i>	140
<i>Necklace with double chain for cows</i>	140
<i>Necklace without chain for cows</i>	140
<i>Needle, disposable sterile, STARVET</i>	161
<i>Needle holder, GUILLES scissors</i>	123
<i>Needle holder, OLSEN-HEGAR scissors with hard mounth (golden handle)</i>	123
<i>Needle holder, OLSEN-HEGAR scissors</i>	123
<i>Needle holder, MATHIEU</i>	123
<i>Needle holder, MAYO</i>	123
<i>Needle, hypodermic</i>	160
<i>Needle, hypodermic, STARVET</i>	159
<i>Needle, hypodermic, STARVET FORTE</i>	158
<i>Neubauer chamber</i>	225
<i>Nigrosine</i>	222
<i>Nose rings, applicator</i>	139
<i>Nose rings, nickel-plated steel</i>	139
<i>Nose rings, HAUPTNER bright steel</i>	139

O

<i>Obstetric blunt hook</i>	110
<i>Obstetric coats</i>	88
<i>Obstetric jackets</i>	88
<i>Obstetric long apron</i>	88
<i>Obstetric overalls</i>	88
<i>Obstetric pointed hook (HARMS)</i>	110
<i>Obstetric trousers</i>	88
<i>Operating table, adjustable electric</i>	113
<i>Otoscope, GOWLLANDS</i>	114
<i>Otoscope-ophthalmoscope, GOWLLANDS</i>	114
<i>Otoscope-ophthalmoscope and laryngoscope, GOWLLANDS</i>	114
<i>Overboots, blue with laces</i>	91
<i>Overboots, disposable with elastic band</i>	91
<i>Overboots, green with laces</i>	91
<i>Overall, disposable with hood "thick" chemical protection</i>	91
<i>Overalls, blue disposable with hood</i>	89
<i>Overalls, blue disposable without hood, green</i>	89
<i>Overalls, green disposable with hood</i>	89
<i>Overalls, green plasticized without hood</i>	89
<i>Overalls, white disposable with and without hood</i>	89
<i>Overalls, white plasticized with and without hood</i>	89
<i>Overalls, washing and cleaning</i>	98
<i>Oversleeves polyester</i>	94
<i>Overshoes with elastic band</i>	91
<i>Ovoscope</i>	212

P

<i>Paddle for mastitis test</i>	153
<i>Pepsin</i>	209
<i>Stethoscope</i>	114

Index

<i>Pig holders</i>	84
<i>Pipette for rabbits semen measuring</i>	200
<i>Pipettes, aspirators for pipettes and automatic pipetes</i>	224
<i>Planing form farm control</i>	72
<i>Plastic bracelets for cattle identification</i>	79
<i>Plastic collars for sheep</i>	79
<i>Plastic seal</i>	78
<i>Pleximeter</i>	106
<i>Polyglycolic acid suture</i>	118
<i>PORKI REP pig calming spray</i>	46-50
<i>Povidone iodine Desinpov of 500ml</i>	115
<i>Probangs</i>	145
<i>Protecting head</i>	113
<i>Pump, dosing for medicines</i>	38
<i>Pump, digital dosing for medicines</i>	38
<i>Pump, peristaltic</i>	221
<i>Pump, programmable for peroxide</i>	38
<i>Pump, standard programmable</i>	38
<i>Pump, stomach</i>	145
<i>Psychrometers</i>	31
<i>PH meters</i>	31
Q	
<i>Quartz bulb economiser lamp-holder</i>	83
<i>Quartz reflectors, clear</i>	82
<i>Quartz reflectors, red</i>	82
R	
<i>Rabbit artificial insemination</i>	198 to 201
<i>Rabbit sperm dosage filling machine</i>	201
<i>Rabbit artificial vagina</i>	200
<i>Rabbit collector sheath</i>	200
<i>Rabbit semen tubes 5ml</i>	200
<i>Rattle paddle, flexible for livestock handling</i>	85
<i>Rattle paddle for livestock handling</i>	85
<i>Rattle paddle, "short" for livestock handling</i>	85
<i>Reagent liquid for California test</i>	153
<i>Refrigerators, fixed semen storage</i>	218 to 219
<i>Refrigerators, semen and vaccines carrying with compressor, 12V-220V</i>	220
<i>Refrigerators, semen and vaccines carrying 12V and idothermal bags</i>	220
<i>Refrigerators, with double pass-through doors for biosafety</i>	217
<i>Repellers, for birds</i>	45
<i>Repellers, for deers</i>	45
<i>Repellers, for moles and rats</i>	45
<i>Repellers, for rabbits</i>	45
<i>Repellers, for wilds pigs</i>	45
<i>Retractor, FARABEUF</i>	111
<i>Retractor, ROUX set</i>	111
<i>Retractor, VOLKMANN</i>	111
<i>Retractor, WEITLANER</i>	111
<i>Rodenticides</i>	44
<i>Ropes, prolapse for dairy cows</i>	110
<i>Ropes, long perlon, double loop</i>	109
<i>Ropes, long perlon, one loop</i>	109
<i>Ropes, sheep prolapse with fastening</i>	110
<i>Ropes, short perlon</i>	109
<i>Rubber docking rings</i>	49
<i>Rumenotomy kit</i>	112
<i>Rumial magnet introducer, flexible</i>	146
<i>Rumial magnet introducer, rigid</i>	146
<i>Rumial magnet, MEDVET super II white</i>	146
<i>Rumial magnet, STARVET, cage form</i>	146
<i>R.U.M. calming spray</i>	46
S	
<i>Safety glasses, 3M anti-fog</i>	92
<i>Safety glasses, 3M colorless ergonomic</i>	92
<i>Safety glasses, 3M ergonomic solar</i>	92
<i>Safety glasses, 3M visit, goggles</i>	92
<i>Sand rope carrier</i>	109
<i>Scales</i>	32-33-39-200

Index

Scalpel blades	101
Scalpel handles	101
Scalpel, LINDE	110
Scanner gel, STARVET-SONIC	208
Scientific glass	222-225
Scissors	102-103
Scissors, IRIS	103
Scissors, JESCO	103
Scissors, LISTER bandage	103
Scissors, LITTAUER to suture removal	103
Scissors, MAYO-STILLE	103
Scissors, METZENBAUM	103
Scissors, SPENCER to suture removal	103
Scraper	125
Sheep and goat milking pump	151
Sheep shears	132
Sheaths	155
Shoulder protection	88
Shovels, dispending	39
Shovels, dispending with built-in scale	39
Sorting board for livestock handling (INSERBO)	85
Slides and slides cover	222
Slides dispenser	222
Sodium chloride	225
Speedy drencher bottle with probe and valve	152
SPLAYLEGSTOP self-adhesive, anti-splay tape to counteract splay leg in piglets	47
Squeegee	125
Straws	155
Straws defroster	155
Straw cutter	155
Stunners, pincers for sheeps	41
Stunners, portable with clamp for pigs	41
Staple extracting forceps (sterile)	116-119
Stereomicroscopes	212
Stomach pump	145
Stoves for drying, sterilization and cultives	213
Suture needles for veterinary use	120-121-122
Suture needle, Gerlach	124
Suture needle, prolapse BUHNER	124
Suture needle, REVERDIN	124
Suture stapler with 35 staples (sterile)	116-119
SUPRAMID	118-119
SUPRAMID WHITE, sterile cassette	119
Swabs for ears (cotton)	116
Swabs, sterile to obtain samples	238
Syringes, automatic oral drenching	182 to 190
Syringes, disposable	162-163
Syringes, DRENCHMATIC oral drenching	190
Syringes, ECO-MATIC vaccinators	186
Syringes, FERROMATIC vaccinators	186
Syringes for tuberculin injection, gun form	192
Syringes HAUPTNER for tuberculin injection, bayonet-type cone	192
Syringes HAUPTNER for tuberculin injection, gun form	192
Syringes, GROTEERMAN (without needle)	193-198
Syringes, GROTEERMAN AUTOMATIC (without needle)	198
Syringe, injection for rabbits artificial insemination	198-201
Syringes, intradermical	193 to 198
Syringes, hand oral drenching	189
Syringes, HAUPTNER revolver	180 to 183
Syringe, HAUPTNER vaccinator	182
Syringes, metal	181
Syringes, revolver	181
Syringes, ROUX revolver	184
Syringes, ROUX revolver with extension	184
Syringes, SERENA with extension	187
Syringes, STARVET adjustable	165
Syringes, STARVET at 1m distance	165
Syringes, STARVET battery vaccinators	171
Syringes, STARVET oral drenching	188-189
Syringes, STARVET plain	165

Index

Syringe, STARVET Pour-on	188
Syringes, STARVET vaccinators	166 to 171
Syringes, SOCOREX vaccinators	176 to 179
Syringes, oral drenching	188 to 190
Syringes, PISTOLMATIC oral drenching	190
Syringes, pneumatic	172 to 175
Syringes, VET-MATIC vaccinators	186
Syringes, with straight cannula for rabbit A.I.	198-201
Syringes, without needle	173-184-193-199
T	
Tail bridle	142
Tail docker, electric	50-51
Tail docker, fixed with hands-free spacer	51
Tail docker, of gas	50
Tank, programmable mixing	38
Tape with velcro for cattle (nylon)	79
Tattoo accessories	54 to 61
Tattoo ink, food	59
Tattoo ink, for seized meat	59
Tattoo ink, liquid	61
Tattoo ink, roll-on system	58
Tattoo ink, to mark sheep	65
Tattooing forceps	55-56
Tattooing forceps, HAUPTNER	56
Tattooing forceps, rotary of 5mm and 6 spaces	56
Tattooing hammers, HAUPTNER	54
Tattooing hammers, of aluminium	54
Tattooing hammers, of zinc coated	54
Tattooing hammers with ink tank (INSERFIX)	60-61
Teat dilator, DR NAYLOR	153
Teat disinfectant bottle, Ambic, foaming action	154
Teat disinfectant bottle with water return	154
Teat disinfectant bottle without water return	154
Teat cannulas	153
Teat splitter, BARTELS	153
Teat cannula, Luer Lock	153
Teat cannula, olive type	153
Teat for lamb feeding bottle (red)	147
Teat for small animals	116
Teat splitter, DANISH	153
Teat splitter, HUG	153
Teat splitter, SWISS	153
Tendon clamp, close model and open model	141
Test tubes	239
Thermic cover for rabbits artificial vagina	200
Thermometers, ACCUVET Digi-temp (speed reading)	28
Thermometers, big room	27
Thermometers, digital veterinary	28
Thermometers, digital veterinary with flexible tip	28
Thermometers, digital veterinary large size	28
Thermometers, digital with external probe and with internal probe	30
Thermometers, for liquids	27
Thermometers, for liquids with plastic protection	27
Thermometers, for poultry	27
Thermometers, infrared	29
Thermometers, maximum and minimum	27
Thermometers, room	27
Thermometers, with computer connection	29
Thermometers, with spear	30
Thermometers, wide vet without ring	28
Tick remover	116
Toluene	222
Tooth cutting nipper	49
Tooth grinders	48
Transformer for carrying fridges	220
Trap, for beetles	42
Trap, for flies	42
Trap, for mices	43
Trap, for rats	43

Index

<i>Trichinoscope with screen</i>	209
<i>Trocar, HAUPTNER with 2 cannulas</i>	145
<i>Trocar, metal handle</i>	145
<i>Trocar, plastic screw</i>	145
<i>Trocar, universal sheep (4 sizes in one set)</i>	145
<i>Trocar, wooden handle</i>	145
<i>Troller, of stainless steel for piglets treatment</i>	53
<i>Troller, for Milk stainless steel with pump, mixer and pasteuriser</i>	147
<i>Troller, for Milk with pump, mixer</i>	147
<i>Troller, for piglets treatment with two tanks for pneumatic syringues</i>	175
<i>Troller, for swine artificial insemination</i>	235
<i>Troller with two tanks of 10L for two pneumatic syringues</i>	174
<i>Trousers, disposable individually folded</i>	91
<i>TURBAIR air-assisted sprayer for vaccines 220V and 12V</i>	195
<i>TURBAIR 12V battery, 12V battery charger</i>	195
<i>TURBAIR bag with cable for batteries, 12V</i>	195

U

<i>Udder colth 32x32 cm</i>	154
<i>Ultrasound scanner, FUTURE-1 portable with batteries</i>	204
<i>Ultrasound scanner, FUTURE-2 portable with batteries</i>	207
<i>Ultrasound scanner, FUTURE-WIFI</i>	206
<i>Ultrasound scanner, portable with battery and transrectal liner probe</i>	208
<i>Ultraviolet (UV) sterilizer</i>	213
<i>Umbilical clamp for piglets and lambs</i>	48

V

<i>Vaccinator, "garrocha" 26ml</i>	195
<i>Vaccinator, "garrocha" handle, 3m</i>	195
<i>Vaccinator, "garrocha" spare needle</i>	195
<i>Vagina for artificial insemination rabbits</i>	200
<i>Vagina for artificial insemination rabbits (of silicon)</i>	200
<i>Vaginal and nasal speculum, HARTMANN</i>	108
<i>Vaginal and nasal speculum, KILLIAN</i>	108
<i>Vaginal closing</i>	109
<i>Vaginal closing, HAUPTNER complete</i>	109
<i>Vaginal needles</i>	109
<i>Vaginal speculum, POLANSKY</i>	108
<i>Vaginal speculum with illumination handle</i>	108
<i>Vaginal suture tape</i>	119
<i>Valve for lamb teat, aluminium</i>	147
<i>Valve for lamb teat, plastic</i>	147
<i>Velcro straps for piglets</i>	47
<i>Video cameras for microscope</i>	210
<i>Video camera for microscope with integrated monitor</i>	211
<i>Volumetric flasks</i>	225

W

<i>Wagons for feed</i>	39
<i>Waterbaths, INSERBO stainless steel</i>	214
<i>Waterbaths, INSERBO plastic</i>	215
<i>Waterproof jacket and trouser set</i>	98
<i>Weighband for cattle and pig</i>	142
<i>Wheelbarrow (polyester)</i>	39
<i>Wheelbarrow, for cadavers</i>	40
<i>Wheelbarrow, for cadavers with batteries</i>	40
<i>Wipes, biodegradable wet for sows higiene</i>	228
<i>Wipes, disinfectant for veterinary instruments</i>	101
<i>Wipes, disinfectant wet for sows higiene</i>	228
<i>Wipes, udder disinfectant</i>	154
<i>Wire pig staples</i>	139
<i>Wire pig staples applicator</i>	139
<i>Wire pig staples applicator (HAUPTNER)</i>	139
<i>Wire pig staples applicator universal</i>	139
<i>Wire pig staples (HAUPTNER)</i>	139
<i>Wire rings, chromed</i>	139
<i>Wire rings, HAUPTNER large, niquel-plated</i>	119
<i>Wire rings, nickeled</i>	139
<i>Wire rings, plier for pig</i>	139



OSL®

REPOSICIÓN Y MANTENIMIENTO
MATERIAL BÁSICO
INSTALACIÓN Y MANTENIMIENTO
EQUIPOS PARA LABORATORIO
MATERIAL PARA LA INVESTIGACIÓN
MATERIAL PARA LA FARMACIA Y QUÍMICA



Polígono Ind. Torrefarrera C/ Ponent, 3
TORREFARRERA - (Lleida)
Tel. 973 750 313 Fax 973 751 712
insebio@insebio.com
www.insebio.com

Termómetros Thermometers



DG-100A
20 cm

DG-102
20 cm. Avicultura / Poultry

Termómetro de ambiente (varios modelos)
Room thermometer (several models)



DG-106



DG-105

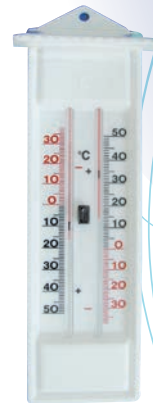

DG-106A

Termómetro de máxima y mínima
DG-105 digital con tejadillo
DG-106 digital tipo botón
DG-106A Tipo botón ecológico

Max and min thermometer
DG-105 digital with canopy
DG-106 digital button type
DG-106A Ecological button type



DG-114 Pinza de sujeción para
termómetros baño maría

DG-114 Clip hold for liquid thermometers



DG-101 **Termómetro** de ambiente
de grandes dimensiones, para
facilitar su visualización desde lejos

DG-101 Big room thermometer
It is seen from a far distance

Alto: 40 cm
Height: 40 cm



DG-118A **Termómetro** para líquidos
con protector de plástico, 120 °C

DG-118A Thermometer for liquids with plastic
protection, 120 °C



DG-115 **Termómetro** para líquidos de 100 °C
DG-116 **Termómetro** para líquidos de 150 °C
DG-117B **Termómetro** para líquidos de 50 °C

DG-115 Thermometer for liquids, 100 °C
DG-116 Thermometer for liquids, 150 °C
DG-117B Thermometer for liquids, 50 °C



DG-112A Termómetro de veterinaria ancho sin anilla
DG-112 Termómetro de veterinaria ancho con anilla

DG-112A Wide veterinary **thermometer** without ring
DG-112 Wide veterinary **thermometer** with ring



DG-111D Termómetro de veterinaria digital, tamaño extragrande

DG-111D Digital veterinary **thermometer**, large size

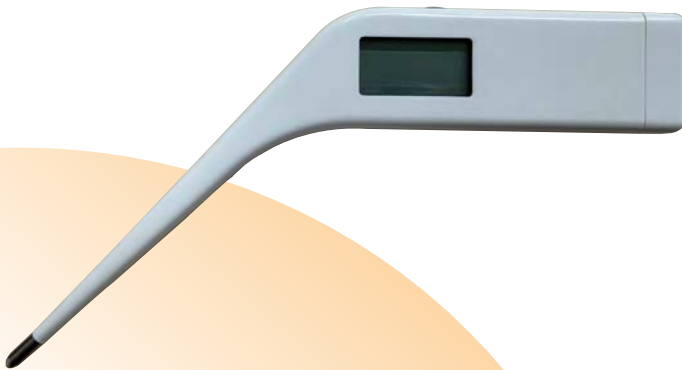

DG-111DA Termómetro de veterinaria digital, extragrande inclinado

DG-111DA Extra large tilted digital veterinary **thermometer**

DG-111 Termómetro de veterinaria digital
DG-111A Termómetro de veterinaria digital
DG-111B Termómetro de veterinaria digital "punta flexible"

DG-111 Digital veterinary **thermometer**
DG-111A Digital veterinary **thermometer**
DG-111B Digital veterinary **thermometer** with flexible tip



DG-111



DG-111A



DG-111B



DG-111C Termómetro de veterinaria digital ACCUVET - Digi-temp lectura rapida
DG-111CC Termómetro de veterinaria digital (eco)

DG-111C Digi-temp digital veterinary **thermometer**
DG-111CC Digital veterinary **thermometer**

Termómetros Thermometers



DG-111E Termómetro de infrarrojos para animales (veterinaria)

DG-111E Infrared thermometer for animals (veterinary)



DG-107 al DG-109 Detector de temperatura para conexión a ordenador, con programa para realizar gráficos, datos, etc. (varios modelos)

DG-107 to DG-109 Temperature detector for computer connection, with programme to make graphics, data, etc (several models)

Con la ventaja añadida de poder saber si en algún momento del día (hora y minutos exactos) la temperatura se ha modificado. Ideal para neveras, etc.

With the advantage of being able to know if the temperature has changed at any time (exact time and minute) Ideal for conservation fridges etc.



DG-113 Termómetro de infrarrojos digital a distancia (blister)

DG-113 Remote digital infrared thermometer (blister pack)



DG-113A Termómetro de infrarrojos digital a distancia

DG-113A Remote digital infrared thermometer

Ideales para saber la temperatura, al momento, de cámaras frigoríficas, placas de calefacción, superficies, paredes, suelos, motores, equipos de refrigeración, calefacción, etc.

Ideal for instantly temperature measuring of cold-storage rooms, heating plates, surfaces, walls, floors, engines, refrigeration equipment, heating, etc.



DG-109S Detector-registrador de temperatura y humedad con USB integrado

DG-109S USB temperature and humidity detector-logger

Termómetro con lanza
Thermometer with spear

DG-119E Digital 300 mm
DG-119G 120 mm



DG-103 Higrómetro de esfera de Ø130 mm
DG-103 Sphere *hygrometer*, Ø130 mm

DG-103A Higrómetro de esfera de Ø85 mm
DG-103A Sphere *hygrometer*, Ø85 mm



DG-119G

DG-119E



DG-113C Higrómetro digital instantáneo de máx. y mín.

DG-113C Maximun and minimum digital instant *hygrothermometer*

DG-119FG Termómetro Deltatrak jumbo con lanza/sonda aguja

DG-119G Deltatrak jumbo *thermometer* with lance/needle probe



DG-113D Higrómetro digital tipo bolígrafo, máx. y mín.

DG-113D Pen-type digital max/min *hygrothermometer*



DG-119B Anemómetro digital

DG-119B Digital *anemometer*



DG-119 Termómetro digital con sonda exterior Inox

DG-119 Digital *thermometer* with external stainless steel probe



DG-119A Termómetro-higrómetro digital máx. y mín. con sonda interior

DG-119A Maximum and minimum digital *thermometer-hygrometer* with inner probe



DG-119C Termómetro-higrómetro digital máx. y mín. con sonda exterior

DG-119C Maximum and minimum digital *thermometer-hygrometer* with external probe

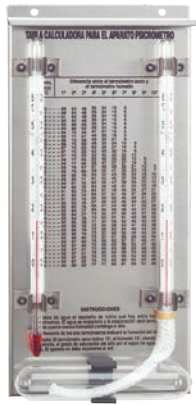

DG-113G Psicrómetro para medir humedad, de acero Inox

DG-103G Stainless steel *Psychrometer* to measure humidity



Termómetros / Phmetros Thermometers / Phmeters

DG-113F Psicrómetro para medir humedad, de plástico

DG-103F Plastic *psychrometer* to measure humidity



IA-280AB Conductímetro con regulación automática de temperatura
IA-280AB *Conductivity meter* with automatic temperature regulation



IA-280AA Phmetro portátil, waterproof con temperatura automática

IA-280AA Portable *PH meter* / Waterproof with automatic temperature

DS-172 Kit reactivo para test de cloro y pH

DS-172 Reagent *kit* for chlorine and pH test

IA-280A Phmetro portátil waterproof

IA-280A Portable waterproof *PH meter*



IA-280T Analizador de la pureza del agua "AQUATESTER"

IA-280T Water purity *analyzer* "AQUATESTER"

Tiras reactivas indicadoras - Indicator test strips

DS-165 De cloro, tubo de 50 uds.
DS-168 De dióxido de cloro, tubo de 50 uds
DS-171 De peróxido, tubo de 50 uds

DS-165 Chlorine, tube of 50 units
DS-168 Chlorine dioxide, tube of 50 units
DS-171 Chlorine Peroxide, tube of 50 units



Cartuchos de humo
Smoke cartridges

DG-170 Humo blanco, 75 seg. 8,5 m³, paq. 10 uds
DG-171 Humo blanco, 180 seg. 17 m³, paq. 5 uds
DG-172 Humo blanco, 150 seg. 55 m³, paq. 5 uds
DG-173 Humo rojo, 180 seg. 17 m³, paq. 5 uds

DG-170 White smoke, 75 sec. 8.5 m³, box of 10 pcs
DG-171 White smoke, 180 sec. 17 m³, box of 5 pcs
DG-172 White smoke, 150 sec. 55 m³, box of 5 pcs
DG-173 Red smoke, 180 sec. 17 m³, box of 5 pcs

DS-175 Medidor Checker de cloro y dióxido de cloro
DS-185 Kit reactivo cloro libre de 0 a 2,5 MG/L (300 Test)

DS-175 Chlorine and chlorine dioxide *Checker meter*
DS-155 Free chlorine *reagent kit* for 0 to 2.5 MG/L (300 Test)



IA-280Q Indicador PH de 0-14, rollo 6 m

IA-280Q *PH indicator* roll (0-14), 6 m





Dinamómetro para pesaje
IN-295 de 5 kg (grad. de 20 g)
IN-300 de 10 kg (grad. de 50 g)
IN-305 de 25 kg (grad. de 100 g)
IN-310 de 50 kg (grad. de 200 g)
IN-315 de 100 kg (grad. de 500 g)
Dynamometer
IN-295 5 kg (20 g accuracy)
IN-300 10 kg (50 g accuracy)
IN-305 25 kg (100 g accuracy)
IN-310 50 kg (200 g accuracy)
IN-315 100 kg (500 g accuracy)



IN-348 Dinamómetro digital de 100 kg con precisión de 50 g

IN-348 Digital dynamometer 100 kg, 50 g accuracy

Dinamómetro digital para pesaje
Digital dynamometer



IN-325 de 5 kg (precisión 5 g)
IN-330 de 10 kg (precisión 10 g)
IN-335 de 20 kg (precisión 20 g)
IN-340 de 30 kg (precisión 20 g)
IN-345 de 50 kg (precisión 50 g)

IN-325 5 kg (5 g accuracy)
IN-330 10 kg (10 g accuracy)
IN-335 20 kg (20 g accuracy)
IN-340 30 kg (20 g accuracy)
IN-345 50 kg (50 g accuracy)

IN-350 Dinamómetro-báscula industrial digital de 1.000 kg

IN-350 Industrial digital dynamometer 1,000 kg

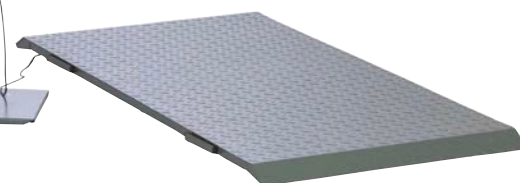

IB-745 Báscula de 1.000 kg con soporte pantalla (150x76x6 cm)

IB-745 Scale with display support of 1,000 kg (150x76x6 cm)

IB-740 Báscula móvil digital para pesar lechones en grupo, 1.000 kg

IB-740 Digital mobile scale to weigh piglets in group (1,000 kg)



IB-735 Báscula móvil digital de aluminio, 300 kg

IB-735 Digital aluminium mobile scale (300 kg)



IB-720 Báscula barras pesaje 1,2mts de largo con display 1.000kg

IB-721 Báscula barras pesaje 1,2mts de largo con display 3.000kg

IB-720 Bar scale weighing 1.2mts long with 1,000kg display

IB-721 Bar scale weighing 1.2mts long with 3,000kg display



Dinamómetros / Básculas

Dynamometers / Scales

Báscula para pesaje de animales

IB-730 Campo pesaje de 300 kg, lectura 200 g

PA-600 Campo pesaje de 150 kg, lectura 100 g

- Plataforma de acero Inox de 90 cm de largo x 55 cm de ancho con alfombra de caucho antideslizante de serie.
- Pantalla digital con soporte mural
- Tara
- Auto-off para ahorro de energía
- Programa específico para el pesaje de animales
- Alimentación de 220 V con adaptador suministrado de serie o mediante 6 pilas AA de 1,5 V (no incluidas)
- Asidero y 2 ruedas para su fácil transporte



Scale for animals

IB-730 up to 300 kg (200 g reading)

PA-600 up to 150 kg (100 g reading)

- Stainless steel platform 90 cm long x 55 cm wide, supplied with an anti-slippery rubber mat
- Digital display
- Tare
- Automatic shut down energy saver
- Specific program to weigh animals
- 220 V power supply (adaptor included) or by means of 6 AA 1.5V batteries (not included)
- Supplied with a handle and 2 wheels for an easy transportation

IB-728 Báscula digital de 150 kgs plataforma de 40x30 cm

IB-728 Digital scale of 150 kg platform of 40x30 cm



Pesas de calibración acero inox.
Stainless steel **calibration weights**

IA-299A 1gr.

IA-299C 5 gr.

IA-299B 2 gr.

IA-299D 100 gr.



IA-295 Báscula electrónica acero inox estanca, 15 kg, precisión 1 g

IA-295 SS sealed **electronic scale**, 15 kg, 1 g accuracy



IB-725 Báscula digital para pesar animales hasta 20 kg

IB-725 Digital scale (up to 20 kg) for animals



IA-294A Báscula electrónica 2 kg, precisión 1 g

IA-294A Electronic scale (2 kg) 1 g accuracy

Báscula digital de bolsillo
Digital pocket scale

IA-298A 500 g, precisión 0,1 g

IA-298B 250 g, precisión 0,1 g

IA-298A 500 g (0.1 g accuracy)

IA-298B 250 g (0.1 g accuracy)



IA-294C Báscula electrónica 6 kg, precisión 1 g

IA-294C Electronic scale (6 kg) 1 g accuracy

Disponemos de básculas desde 600 g, hasta 12 kg, con precisión de 1 g
Scales from 600 g to 12 kg with 1 g accuracy available

Bebederos pico pato acero Inox
Stainless steel *nipple drinkers*

Bebederos
Drinkers



IB-116



IB-115



IB-330



IB-325



IB-345

- IB-115** hexagonal con filtro
- IB-116** normal con filtro
- IB-320** boca larga, 1/2"
- IB-320B** boca larga, 1/2" con filtro
- IB-330** 1/2" hexagonal boca larga
- IB-331** 1/2" (tapa azul)
- IB-325** hexagonal grande, 1/2"
- IB-345** hexagonal pequeño, 1/2"
- IB-376** para tolvas, rosca interior 3/8"

- IB-115 Hexagonal with filter*
- IB-116 Normal with filter*
- IB-320 1/2" long mouth*
- IB-320B 1/2" long mouth with filter*
- IB-330 1/2" hexagonal (large mouth)*
- IB-331 1/2" (blue cap)*
- IB-325 1/2" hexagonal (big)*
- IB-345 1/2" hexagonal (small)*
- IB-376 for feeders 3/8" , internal thread*



IB-331



IB-320



IB-320B



IB-376



IB-350



IB-355

- IB-350** Bebedero pico pato latón hexagonal pequeño, 1/2"
- IB-355** Bebedero pico pato latón hexagonal, 1/2"

- IB-350 Brass 1/2" hexagonal nipple drinker (small)*
- IB-355 Brass 1/2" hexagonal nipple drinker*



IB-375A



IB-375



IB-370



IB-370A



IB-371



IB-379



IB-379A



IB-380

- IB-370 Bebedero humedecedor acero Inox para tolvas, 1/2"
- IB-370A Bebedero humedecedor acero Inox para tolvas, 1/2" (azul)
- IB-371 Bebedero humedecedor acero Inox para tolvas, 1/2" (azul) "1 Pieza"
- IB-375 Bebedero de acero Inox para tolvas, rosca interior de 3/8"
- IB-375A Bebedero de acero Inox para tolvas, rosca interior de 1/2"
- IB-379 Bebedero de acero Inox humedecedor lengüeta larga de 1/2"
- IB-379A Bebedero de acero Inox humedecedor lengüeta corta de 1/2"
- IB-380 Bebedero de acero Inox humedecedor de 1/2" (tapa azul)

- IB-370 1/2" stainless steel *nipple drinker* for feeders
- IB-370A 1/2" stainless steel *nipple drinker* for feeders (blue)
- IB-371 1/2" stainless steel *nipple drinker* for feeders (blue) "1 piece"
- IB-375 Stainless steel 3/8" *nipple drinker* for feeders
- IB-375A Stainless steel 1/2" *nipple drinker* for feeders
- IB-379 1/2" stainless steel *nipple drinker* humidifier with long pin
- IB-379A 1/2" stainless steel *nipple drinker* humidifier with short pin
- IB-380 1/2" stainless steel *nipple drinker* humidifier (blue cap)



IB-399 Conjunto de piezas y codos para salida doble para chupetes

IB-399 Set of parts and elbows for double outlet for pacifier

CHUPETES NO INCLUIDOS
NIPPLE DRINKERS NOT INCLUDED

Bebederos Drinkers



IB-360



IB-365



IB-365A



IB-335



IB-378

IB-360 Bebedero aspersor acero Inox con 3 agujeros, 1/2"

IB-365 Bebedero aspersor acero Inox con ranura, 1/2"

IB-365A Bebedero aspersor acero Inox con ranura, 1/2" (Tapa Azul)

IB-335 Bebedero tipo bola acero Inox de 1/2" hexagonal

IB-360 Stainless steel sprinkler nipple drinker 1/2"

IB-365 Sprinkler nipple drinker with groove 1/2"

IB-365A Sprinkler nipple drinker with groove 1/2" (Blue cap)

IB-335 Stainless steel ball type nipple drinker 1/2" hexagonal

IB-378 Bebedero de acero Inox para cazoleta, 1/2"

IB-378 Stainless steel drinker for bowl, 1/2"



IB-600

IB-600 Bebedero con protector 1/2"

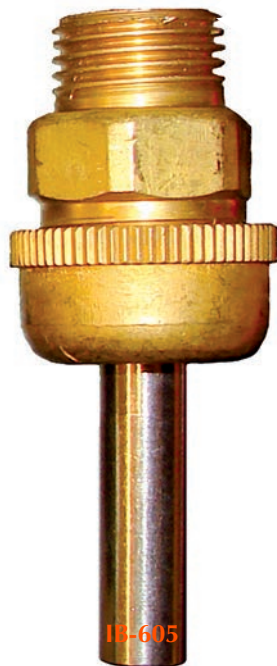

IB-605

IB-605 Bebedero sin protector 1/2"

IB-600 1/2" Drinker with protection

IB-605 1/2" Drinker without protection.



IB-377

IB-377 Bebedero de acero Inox para cazoleta, rosca interior de 1/2"

IB-377A Bebedero de acero Inox para cazoleta, rosca interior de 1/2" (Con filtro)

IB-377 Stainless steel nipple drinker, 1/2" internal thread

IB-377A Stainless steel nipple drinker, 1/2" internal thread (with filter)



IB-377A

IB-615

IB-640

IB-635



IB-610



IB-625



IB-620



IB-630

IB-610 Boquilla Inox

IB-615 Protector

IB-620 Muelle

IB-625 Varilla latón y plástico

IB-630 Goma y arandela Inox

IB-635 Tuerca latón

IB-640 Cuerpo latón

IB-610 Stainless steel mouthpiece

IB-615 Protection

IB-620 Spring

IB-625 Plastic and brass rod

IB-630 Washer and stainless steel plate

IB-635 Brass screw

IB-640 Brass body

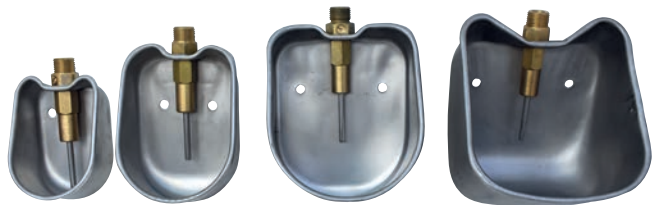

Bebedero cazoleta de acero Inox
Stainless steel *bowl drinker*

- | | |
|--|-------------------------------------|
| IB-220 Lechones maternidad nº 1 | IB-220 Piglets maternity nº1 |
| IB-225 Lechones destete nº 2 | IB-225 Weaning Piglets nº2 |
| IB-230 Engorde nº 3 | IB-230 Fattening nº3 |
| IB-235 Cerdas madres nº 4 | IB-235 Mother sows nº4 |



Bebedero porcino de acero Inox
Stainless steel *pig drinker*

- | | |
|-----------------------|----------------------|
| IB-250 Grande | IB-250 Big |
| IB-255 Mediano | IB-255 Medium |
| IB-260 Pequeño | IB-260 Small |

Bebedero aluminio pintado
Painted aluminum *drinker*

- | | |
|------------------------------|----------------------------|
| IB-264 Transición | IB-264 Transition |
| IB-265 Cebo/Madres | IB-265 Bait/Mothers |
| IB-266 Madres grandes | IB-266 Big mothers |



IB-185 Bebedero para ovejas completo con boya 10/100

IB-185 Sheep *drinker* with float 10/100



- IB-205 Bebedero** vacuno de acero Inox con boya de 10/100
IB-205A Bebedero vacuno de acero Inox con boya de 3/8
IB-205B Bebedero vacuno de acero Inox con boya de 3/8 (animales pequeños)

IB-205 Stainless steel 10/100" cattle *drinker* with buoy
IB-205A Stainless steel 3/8" cattle *drinker* with buoy
IB-205B Stainless steel 3/8" cattle *drinker* with buoy (small animals)



IB-204 Bebedero para vacuno vitrificado

IB-204 Vitrified cattle *drinker*



IB-200 Bebedero para vacuno de acero Inox con lengüeta

IB-200 Cattle *drinker*, stainless steel



IB-214A Bebedero grande alargado de 42 l (100x35x24cm)

IB-214 Bebedero grande alargado de 42 l con entrada de agua y flotador (100x35x24cm)

IB-214A Large elongated *drinker* 42 l (100x35x24cm)

IB-214 Large elongated *drinker* 42 l with water intel and buoy (100x35x24cm)



- IB-275 Bebedero** de plástico de 5,5 l
IB-280 Bebedero de plástico de 12 l

IB-275 Plastic *drinker* 5.5 l
IB-280 Plastic *drinker* 12 l

Bebederos / Comederos / Bombas / Palas Drinkers / Feeders / Pumps / Scoops



IB-100 Bebedero para medicar lechones con depósito de 5 l
IB-105 Bebedero para medicar lechones sin depósito
IB-100 Drinker for piglets medication with a 5 l tank
IB-105 Drinker for piglets medication without tank



IB-453 Bomba dosificadora
 Aquablend 0,8% - 5%

IB-453 Aquablend Dosing pump 0,8% - 5%

IB-465 Depósito mezclador programable de 120 l

IB-465 Programmable mixing tank, 120 l



IB-455 Bomba dosificadora para medicamentos, de 1% a 5%

IB-455 Dosing pump for medicines, 1% to 5%

Comedero 1ª edad Inox para lechones

Stainless steel feeder for piglets

IB-300 ⌀ 25x5cm de alto
IB-301 ⌀ 25x6cm de alto

IB-300 ⌀ 25x5cm high
IB-301 ⌀ 25x6cm high



IB-305 Comedero 1ª edad Inox para lechones, grande

IB-305 Stainless steel feeder for piglets (big model)



DS-150 Bomba dosificadora digital para medicar

DS-150 Digital dosing pump to medicate



DS-140 programable para peróxido 220 v
DS-145 programable standard 220 v

DS-140 Programmable for peroxide 220 V
DS-145 Standard programmable for 220 V



DS-141 programable para peróxido 12 v
DS-146 programable standard 12 v

DS-141 Programmable for peroxide 12 V
DS-145 Standard programmable for 12 V

Bomba dosificadora digital / Digital dosing pump



IB-812 Pala dispensadora de pienso galvanizada, 2 kg

IB-812 Galvanised *dispensing shovel* 2 kg



Pala dispensadora de aluminio redonda
Round aluminum dispensing shovel

- IB-825** 900 g
- IB-825A** 1.100 g
- IB-826** 1.600 g
- IB-827** 2.500 g

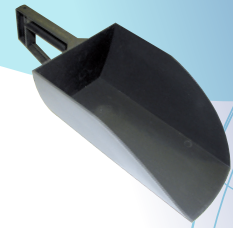

Pala dispensadora para pienso
Feed dispensing shovel

- IB-810** 1 kg
- IB-811** 2 kg



IB-815 Pala-jarra dispensadora sólidos-líquidos 2 l, 2 kg

IB-815 Solid/liquid food scoop 2 l/2 kg



IB-820 Pala dispensadora con báscula incorporada

IB-820 Dispensing shovel with built-in scale



IB-747 Vagoneta de 200 kg con báscula digital, 3 ruedas

IB-747 3 wheels Wagon with digital scale (200kg)



Vagoneta para pienso poliéster
Polyester wagon for feed

- IB-871** 100 kg, 3 ruedas
- IB-885** 200 kg, 3 ruedas
- IB-880** 300 kg, 3 ruedas

IB-871 100 kg, 3 wheels
IB-885 200 kg, 3 wheel
IB-880 300 kg, 3 wheel



Vagoneta para pienso poliéster
Wagon for polyester feed

- IB-870** 100 kg, 4 ruedas
- IB-875** 200 kg, 4 ruedas
- IB-890** 300 kg, 4 ruedas

IB-870 100 kg, 4 wheel
IB-875 200 kg, 4 wheel
IB-890 300 kg, 4 wheel



IB-895 Carretilla poliéster extra-grande, 1 rueda 140 l

IB-895 Extre-large polyester wheelbarrow, 1 wheel 140 l



IB-865 Carretilla de bajas "a baterías" hasta 130 kg

IB-865 Carcass **trolley** with batteries, up to 130 kg



IB-867 Carretilla de bajas "a baterías" hasta 300 kg

IB-867 Carcass **trolley** with batteries, up to 300 kg



IB-868 Plataforma "TRANSPORKER" para bajas

IB-868 "TRANSPORKER" **platform** for carcass



IP-113 Sacos negros grandes gruesos de 85x105 cm., caja de 180 u (para cadáveres, basura, etc)

IP-113 Large thick **black bags** of 85x105 cm, box of 180 units (for corpses, garbage, etc.)



IB-850 Carretilla de bajas standard
IB-855 Carretilla de bajas grande

IB-850 Carcass **trolley**, standard
IB-855 Carcass **trolley**, large



IB-863 Carretilla de bajas acero Inox con 2 ruedas, mediana

IB-863 Stainless steel carcass **trolley** with 2 wheels, medium

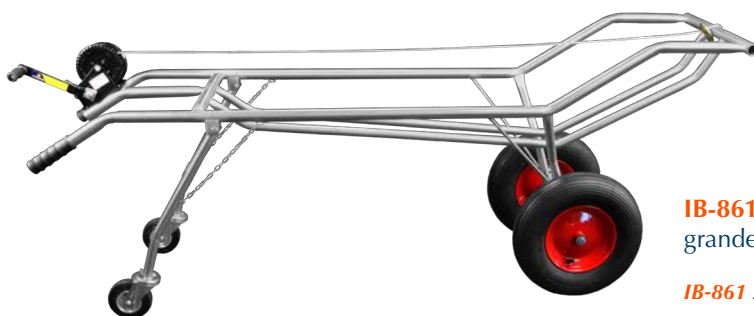

IB-861 Carretilla de bajas acero Inox con 4 ruedas, grande

IB-861 Stainless steel carcass **trolley** with 4 wheels, large

Carretillas / Pistolas / Exterminadores

Trolleys / Pistols / Exterminators



IC-320 Cartucho para porcino y becerros (verde), paq. 50 uds

IC-325 Cartucho para vacas y caballos (amarillo), paq. 50 uds

IC-330 Cartucho para bueyes y toros (azul), paq. 50 uds

IC-335 Cartucho para toros grandes (rojo), paq. 50 uds

IC-320 Cartridge for pigs and calves (green), box of 50 units

IC-325 Cartridge for cows and horses (yellow), box of 50 units

IC-330 Cartridge for bulls (blue), box of 50 units

IC-335 Cartridge for big bulls (red), box of 50 units

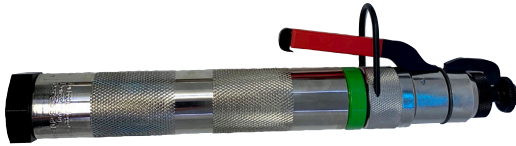

IC-305 Pistola para sacrificio de lechones

IC-305 Piglet slaughter gun

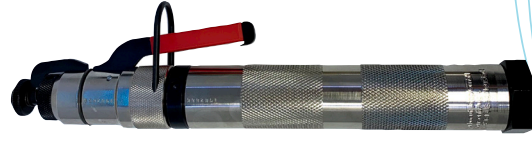

IC-300 Pistola para sacrificio de animales

IC-300 Animal slaughter gun



IC-297 Pistola para sacrificios de conejos

IC-297 Rabbit slaughter gun



IC-298 varilla de descabello, paq. 25 uds

IC-298 Pithing Rod, bag of 25 pcs



IC-275 Aturdidor eléctrico portátil con pinza para porcino

IC-275 Portable electric stunner with clamp for pigs

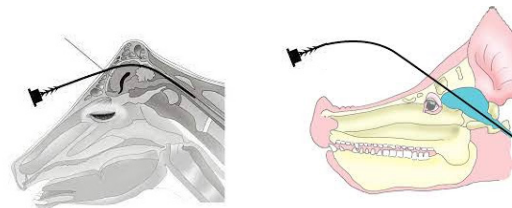

IC-280 Pinza aturdidora para ovejas

IC-280 Sheep stunning pincers



Exterminador de insectos electrónico
Electronic insect exterminator

- II-150** para 30 m² *II-150 for 30 m²*
- II-155** para 120 m² *II-155 for 120 m²*
- II-157** para 160 m² *II-157 for 160 m²*
- II-160** para 200 m² *II-160 for 200 m²*



RA-140 Expositor trampa para moscas, 12 uds

RA-141 Trampa para moscas

RA-140 Fly trap display, 12 pcs

RA-141 Fly trap

RA-155 Expositor trampa para moscas ventana, 6 paq. de 4 uds

RA-156 Trampa para moscas ventana, paq. de 4 uds

RA-155 Window fly trap display with 6 boxes of 4 pcs

RA-156 Window fly trap, box with 4 pcs

RA-145 Expositor trampa para cucarachas, 12 paq. de 2 uds

RA-146 Trampa para cucarachas, paq. de 2 uds

RA-145 Beetle trap display with 12 boxes of 2 pcs

RA-146 Beetle trap, box with 2 pcs



FENDONA
RA-250 1 l
RA-255 0,5 l



RA-180 Raqueta eléctrica matamoscas

RA-180 Electronic fly-swat

Exterminadores Exterminators

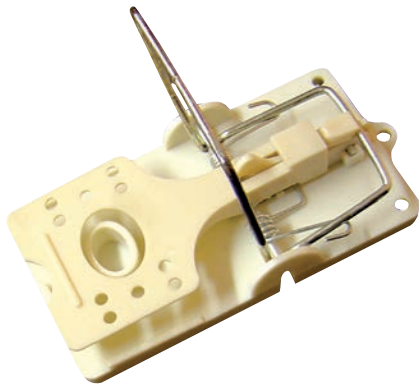

RA-130 Trampa para ratas reforzada
RA-135 Trampa para ratones reforzada

RA-130 Reinforced rattrap
RA-135 Reinforced mice trap



RA-705 Auyentador doble de roedores con ultrasonidos para 400 m²

RA-705 Double ultrasonic rodent repellent fr 400 m²o

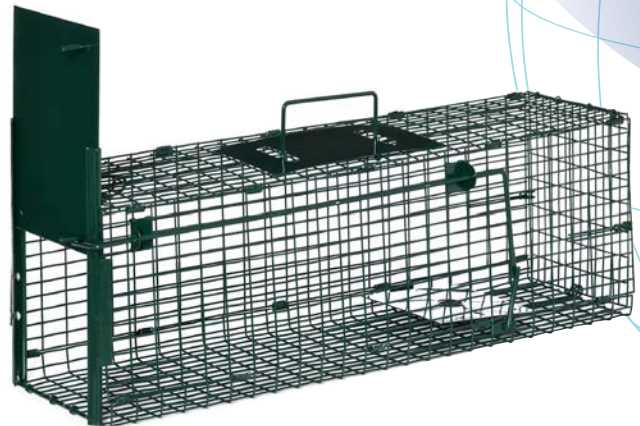

IC-600 Jaula trampa de acero 75x25x25

IC-600 Steel cage tramp 75x25x25



RA-120 Expositor de sobremesa SUPERCAT ratas, 12 uds

RA-120 SUPERCAT rattrap counter display, 12 units



RA-110 Expositor de sobremesa SUPERCAT ratones, 14 cartas de 2 uds

RA-110 SUPERCAT mousetrap counter display, 14 cards of 2 units

RA-105 Trampa para ratas SUPERCAT

RA-105 SUPERCAT rattrap



RA-129 Trampa SUPERCAT para rata de jardín y topillo

RA-129 SUPERCAT trap for garden rat and vole

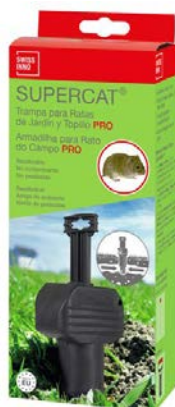

RA-128 Jeringa de cebo natural SUPERCAT, paq. de 2 uds.

RA-128 SUPERCAT natural bait syringe pack of 2 units



RA-100 Trampa para ratones SUPERCAT, carta de 2 uds

RA-100 SUPERCAT mice trap, card of 2 units



Raticida Rodenticide



RA-310 STORM ULTRA 300 gr (pastilla de 5gr)

RA-310 STORM ULTRA 300 gr (5 gr tablet)



RA-315 STORM ULTRA 3kg (pastilla de 5gr)

RA-315 STORM ULTRA 3 kg (5 gr tablet)



RA-320 STORM ULTRA 9kg (pastilla de 5gr)

RA-320 STORM ULTRA 9 kg (5 gr tablet)



RA-240 Estación raticida pequeña **STORM**

RA-241 Estación raticida grande **STORM**

RA-240 Small rodenticide station **STORM**

RA-240 Large rodenticide station **STORM**

Raticidas / Ahuyentadores Rodenticide / Repellers



RA-640 Ahuyentador de conejos y liebres CUNIREP, 5 kg

RA-640 CUNIREP rabbit and hares repeller (5 kg)

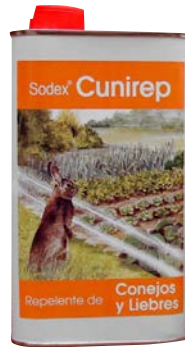

RA-645 Ahuyentador de conejos para cuerdas CUNIREP, 1 l

RA-645 CUNIREP rabbit repeller for rope (1 l)



RA-650 Ahuyentador de conejos para cuerda CUNIREP, 200 m

RA-650 CUNIREP rabbit repeller for rope (200 m)



RA-630 Ahuyentador de jabalí RTA 50, 1 l

RA-652 Ahuyentador para conejos RTA 50, 1 l

RA-630 RTA 50 wild pig repeller (1 l)

RA-652 RTA 50 rabbit repeller (1 l)



RA-620 Spray Ahuyentador de topos y ratones TOPIREP, 650 ml

RA-620 TOPIREP mole and mice spray repeller (650 ml)



RA-680 Ahuyentador de ciervos CERVIREP, 1 l

RA-680 CERVIREP deer repeller (1 l)



RA-685 Ahuyentador de ciervos CERVIREP, paq. de 50 bolsas

RA-685 CERVIREP deer repellent (pack of 50 pieces)



RA-655 Ahuyentador de pájaros ORNIREP, 1 l

RA-655 ORNIREP bird repeller (1 l)



RA-670 Ahuyentador de pájaros ORNIREP, paq. de 50 bolsas

RA-675 Ahuyentador de pájaros ORNIREP, paq. de 10 bolsas

RA-670 ORNIREP bird repeller (pack of 50 pieces)
RA-675 ORNIREP bird repeller (pack of 10 pieces)



RA-760 Disuasor de aves de 5 kg, bolsas de 25 g

RA-765 Disuasor de aves de 1 kg, bolsas de 25 g

RA-760 Bird deterrent (5 kg - bags of 25 g)
RA-765 Bird deterrent (1 kg - bags of 25 g)



RA-750 Disuasor de aves, 5 l

RA-755 Disuasor de aves spray manual, 750 ml

RA-750 Bird deterrent (5 l)
RA-755 Bird manual spray deterrent (750 ml)

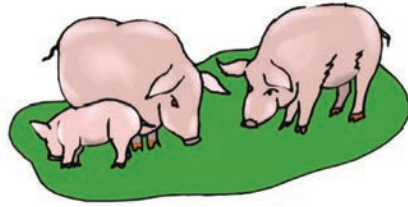

RA-600 Spray tranquilizante de cerdos PORKIREP, 650 ml

RA-600 PORKIREP pig calming spray (650 ml)

Calma a los cerdos y se muestra muy efectivo, evitando las peleas, y el canibalismo, en situación de stress, mezclas, hermanamientos, etc... y también aplicado durante la carga reduce la mortalidad de los animales durante el transporte al matadero.

En casos de estrés en cerdas, evita posibles casos de abortos.

Debido a su efecto preventivo, evita las peleas, mordeduras de colas, orejas, etc... i que se provoquen heridas

It calms the pigs and is very effective, avoiding fights and cannibalism, in situations of stress, mixtures, twinning, etc... and also applied during loading reduces the mortality of animals during transport to the slaughterhouse.

In cases of stress in sows, it avoids possible cases of abortions.

Due to its preventive effect, it prevents fights, biting of tails, ears, etc... and avoiding injuries.

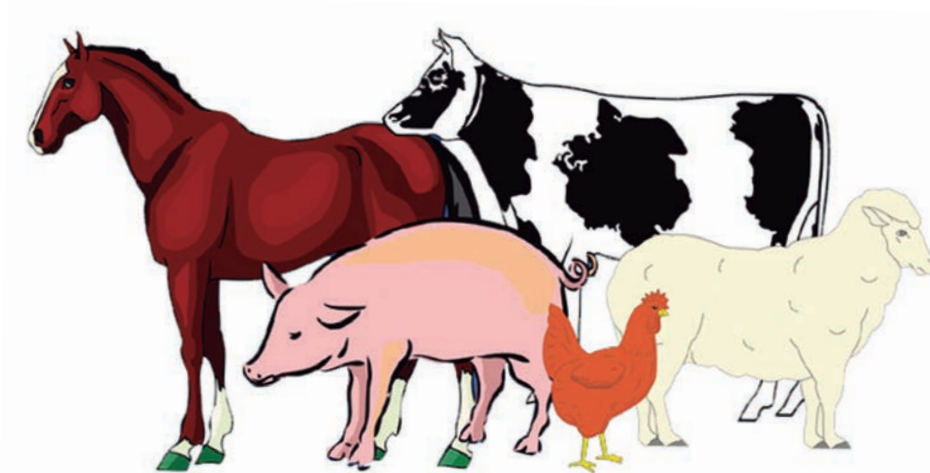

RA-610 Spray tranquilizante R.U.M, 650 ml

RA-610 R.U.M. calming spray (650 ml)



IC-110A Spray manual anti-canibalismo, 500 ml

IC-110A Anticanibalism spray, 500 ml

Spray extremadamente amargo para prevenir, controlar y evitar el canibalismo y mordeduras de colas en cerdos de engorde y lechones.

Posee una acción desinfectante y cicatrizante de secado rápido que reduce el sangrado en animales que ya han sido mordidos

Extremely bitter spray to prevent, control and avoid cannibalism and prevent tail-biting in fattening pigs and piglets.

It has a quick-drying disinfectant and healing action that reduces bleeding in animals that have already been bitten.

Sprays / Pelotas / Carros

Sprays / Balls / Trolleys



IB-415 Cubo fun box colgable para bienestar animal

IB-415 Hanging fun box cube for animal welfare



IB-414 Bola colgable especial para bienestar animal

IB-414 Special hanging ball for animal welfare



IB-416 Tubo acero inox para morder materia orgánica

IB-416 Stainless steel tube to bite organic matter



IB-400 Pelota antiestrés para porcino

IB-400 Anti-stress ball for pigs

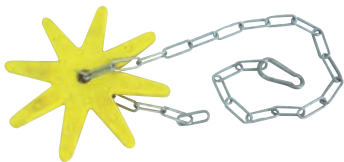

IB-410 Estrella antiestrés para porcino con cadena-cierre completa

IB-410 Anti-stress star for pigs (with chain and buckle)



IB-420 Juguete para lechones Easyfix Luna 86

IB-420 Toy for piglets Easyfix Luna 86

IB-400A Pelota antiestrés para porcino completa con cadena-grillete para colgar

IB-400A Anti-stress ball for pigs complete with chain-shackle for hanging



IC-118C SPLAYLEGSTOP para lechones, prevención patas abiertas, paq. 20 uds

IC-118C SPLAYLEGSTOP Self-adhesive, anti-splay tape to counteract splay leg in piglets (20 pcs in a package)



IC-118A Cinta velcro para lechones, paq. 12 uds

IC-118A Velcro straps for piglets, 12 pcs bag



IN-122A Bozal grande para cerdas

IN-122A Sows big muzzle



IC-108AC Lima dental INSERTO, de baterías extra con alargo

IC-108AC INSERTO tooth grinder, with extra batteries and extension



IC-108AA Lima dental con alargo INSERTO, 220 V

IC-108AA INSERTO tooth grinder 220 V with extension



IC-108BB Capuchón protector metálico lima dental parte alargo

IC-108BB Metal protective cap tooth grinder extension part



IC-107 Punta lima dental de recambio

IC-107 Spare file for tooth grinder



IC-117 Pinza umbilical para lechones y corderos

IC-117 Umbilical clamp for piglets and lambs

Limas / Tenazas Grinders / Nippers



IC-100 Tenaza corta colmillos, acero Inox

IC-100 Tooth cutting nipper, stainless steel



IC-105 Tenaza corta colmillos de acero Inox extra

IC-105 Tooth cutting nipper, extra, stainless steel



IC-104 Tenaza corta colmillos HAUPTNER

IC-104 HAUPTNER tooth cutting nipper



IC-111 Tenaza para gomas descolar

IC-111 Rubber ring applicator



IC-112 Tenaza para gomas descolar, plástico

IC-112 Rubber ring plastic applicator



IP-215 Guantes obstétricos porcino, 90 cm, bolsa de 5 unidades

IP-215 Pig obstetric gloves, 90 cm, 5 units bag



IC-116 Anillas de goma para descolar, paq. de 100 uds
IC-115 Anillas de goma para descolar, paq. de 500 uds

IC-116 Rubber docking rings, bag of 100 units
IC-115 Rubber docking rings, bag of 500 units



IC-122 Tubo recambio corta colas a gas

IC-122 Spare tube for gas tail docker



IC-124 Gas para corta colas, 250 ml

IC-124 Gas for tail docker 250 ml



IC-120 Corta colas de gas (se suministra con carga de gas), 250 ml

IC-120 Gas tail docker (supplied with a 250 ml gas can)



IC-121 Cuchilla para corta colas

IC-121 Spare Blade for tail docker



DS-850 Spray INTRA microderm de 250 ml

DS-850 INTRA microderm spray 250 ml



IC-174 Cuchilla para corta colas eléctrico

IC-174 Spare blade for electrical tail docker



IC-170 Corta colas eléctrico

IC-170 Electrical tail docker



RA-600 Spray tranquilizante de cerdos PORKIREP, 650 ml

RA-600 PORKIREP pig calming spray, 650 ml



IC-110A Spray manual anti-canibalismo, 500 ml

IC-110A Anticanibalism spray, 500 ml



IC-110 Spray anti-cannibalismo, 400 ml

IC-110 Anticanibalism spray, 400 ml

Corta colas Tail-dockers



IC-181 Corta colas eléctrico con carcasa y cuchilla con forma de media luna (IC-175A)

IC-181 Electric tail ducker with casing, crescent-shaped blade (IC-175A)



IC-180 Corta colas eléctrico con carcasa y cuchilla en forma de "M" (IC-175)

IC-180 Electric tail ducker with casing, blade "M" (IC-175)



IC-186 Cuchilla de recambio para corta colas, "V"

IC-186 Spare blade for tail ducker, "V"



IC-175 Cuchilla de recambio para corta colas, "M"

IC-175 Spare blade for tail ducker, "M"



IC-185A Corta colas eléctrico sin carcasa y cuchilla en forma de "V" (IC-186)

IC-185A Electric tail ducker without casing, "V" blade (IC-186)



IC-185 Corta colas eléctrico sin carcasa y cuchilla plana (IC-187)

IC-185 Electric tail ducker without casing, flat blade (IC-187)



IC-175A Cuchilla de recambio para corta colas, media luna

IC-175A Spare blade for tail ducker, with crescent-shaped



IC-187 Cuchilla de recambio para corta colas, plana

IC-187 Spare blade for tail ducker, flat



IC-185C Corta colas eléctrico sin carcasa, cuchilla en forma de media luna (IC-175A)

IC-185C Electric tail ducker without casing, crescent-shaped blade (IC-175A)



IC-185B Corta colas eléctrico sin carcasa y cuchilla en forma de "M" (IC-175)

IC-185B Electric tail ducker without casing, "M" blade (IC-175)



IC-183 Corta colas fijo con distanciador manos libres
IC-184 Corta colas fijo con distanciador y potenciómetro

*IC-183 Fixed tail ducker with hands-free spacer
IC-184 Fixed tail ducker with potentiometer*



IC-184A Soporte para corta colas fijo, manos libres

IC-184A Support for fixed tail ducker



IC-133 Emascador doble boca para caballos REIMERS, 31 cm

IC-133 Reimers horse emasculator, 31 cm double mouth



IC-125 Emascador recto HAUSSMAN, 19 cm

IC-131 Emascador recto HAUSSMAN, 27 cm

IC-125 Haussman emasculator, 19 cm straight

IC-131 Haussman emasculator, 27 cm straight



IC-130 Emascador curvo HAUSSMAN, 19 cm

IC-131A Emascador curvo HAUSSMAN, 27 cm

IC-130 Haussman emasculator, 19 cm curved

IC-131A Haussman emasculator, 27 cm curved



Burdizo articulado
Articulated castrator

IC-220 30 cm

IC-223 34 cm

IC-225 40 cm

IC-230 48 cm



IC-132 Emascador para caballos VERBOCZY, 27 cm

IC-132 VERBOCZY horse emasculator, 27 cm



IC-215 Burdizo articulado para castrar metálico, 23 cm

IC-215 Metallic articulated castrator, 23 cm



IC-133K Pinza-Forceps para castración porcino con hoja nº24

IC-133K Castration forceps for pigs with 24 size blade



IC-132A Emascador SERRA de 31 cm

IC-132A SERRA emasculator, 31 cm



IC-243 Separador retractor para caponaje de aves de 19 cm

IC-243 19 cm retractor for poultry castration



IC-242 Polipotomo para castración de aves

IC-242 Polipotom for poultry castration

Emasculadores / Potros Emasculators / Castration devices



IC-205 Potro para castración de lechones standard

IC-205 Standard castrating table for piglets



IC-200 Potro para castración de lechones (tipo asiento)

IC-200 Castrating table for piglets



Potro para castración acero Inox, con soporte
Piglet castration device

IC-190 Lechones de 2 a 9 días

IC-190 from 2 to 9 days



IC-118B Pinza-alargo recoge lechones tipo revólver de 80 cm

IC-118B Revolver-type piglet claw of 80 cm



IB-847 Caja para transportar utensilios en ganadería

IB-847 Box to transport utensils in livestock



IB-845 Cubeta de plástico con asa para llevar instrumentos, gris (reforzada)

IB-846A Cubeta de plástico para instrumentos, azul

IB-845 Plastic tray, grey (reinforced)

IB-846A Plastic tray, blue



IA-669A Carro-mesa para tratamiento de lechones, en acero Inox

IA-669A Piglets treatment trolley stainless steel

NO INCLUYE POTRO NI CORTA COLAS
Castration devices not included

Potro para trabajos en lechones
Piglet castration device

IC-190 De 2 a 9 días

IC-190 2 to 9 days

ID-098 Martillo de 6 casillas HAUPTNER, sin accesorios

ID-098 HAUPTNER tattooing hammer; 6 divisions. Without accessories



Martillo doble fila HAUPTNER, sin accesorios
HAUPTNER tattooing hammer, double row, without accessories

ID-098A de 8 casillas

ID-098A 8 divisions

ID-098B de 12 casillas

ID-198B 12 divisions

ID-098C de 14 casillas

ID-198C 14 divisions



Martillo de aluminio, sin accesorios

Aluminium tattooing hammer, without accessories

ID-097 de 6 casillas

ID-097 6 divisions

ID-097A de 7 casillas

ID-097A 7 divisions

ID-103D de 8 casillas

ID-103D 8 divisions

ID-103F de 10 casillas

ID-103F 10 divisions



Martillo de aluminio doble fila, sin accesorios

tattooing hammer with double row, aluminium, without accessories

ID-103B de 10 casillas

ID-103B 10 divisions

ID-103C de 8 casillas

ID-103C 8 divisions

ID-103E de 14 casillas

ID-103E 14 divisions

ID-103G de 12 casillas

ID-103G 12 divisions



Martillo de hierro zincado

Zinc coated tattooing hammer

ID-096 de 4 casillas

ID-096 4 divisions

ID-096A de 5 casillas

ID-096A 5 divisions

ID-096B de 6 casillas

ID-096B 6 divisions

ID-096C de 7 casillas

ID-096C 7 divisions

ID-096D de 8 casillas

ID-096D 8 divisions



Martillo de hierro zincado, doble fila

Zinc coated hammer, double row

ID-096E de 8 casillas

ID-096E 8 divisions

ID-096F de 10 casillas

ID-096F 10 divisions

ID-096G de 12 casillas

ID-096G 12 divisions

ID-096H de 14 casillas

ID-096H 14 divisions





Tatuadora lineal HAUPTNER, sin accesorios
HAUPTNER linear tattooing forceps without accessories

ID-191 5 mm, 7 casillas **ID-191** 5 mm, 7 divisions
ID-192B 7 mm, 7 casillas **ID-192B** 7 mm, 7 divisions



ID-192A Tatuadora de 5 mm, 4 casillas HAUPTNER

ID-192A HAUPTNER tattooing forceps 5 mm, 4 divisions



Tatuadora HAUPTNER, sin accesorios
HAUPTNER tattooing forceps, without accessories

ID-192 7 mm, 7 casillas **ID-192** 7mm, 7 divisions
ID-189 7 mm, 9 casillas **ID-189** 7mm, 9 divisions



ID-195 Tatuadora de 10 mm, 5 casillas sin accesorios HAUPTNER

ID-198 Tatuadora de 10 mm, 5 casillas

ID-205 Tatuadora de 15 mm, 5 casillas sin accesorios HAUPTNER

ID-195 HAUPTNER tattooing forceps 10 mm, 5 divisions, without accessories

ID-198 tattooing forceps 10 mm, 5 divisions

ID-205 HAUPTNER tattooing forceps 15 mm, 5 divisions, without accessories



ID-190 Tatuadora de 14 casillas, sin accesorios, 7 mm

ID-190 7 mm tattooing forceps, 14 divisions without accessories



ID-188C Carácteres para tatuadora de 14 casillas, 7 mm

ID-188C 7 mm symbol for tattooing forceps, 14 divisions



ID-193A Tatuadora articulada, 10 mm de 5 casillas doble fila

*ID-193A 10 mm articulated **tattooing forceps**, double row, 5 divisions*

ID-194 Tatuadora articulada de 10 mm de 6 casillas HAUPTNER

*ID-194 HAUPTNER **tattooing forceps** 10 mm, 6 divisions articulated*



ID-193 Tatuadora articulada de 10 mm de 6 casillas doble fila HAUPTNER

*ID-193 HAUPTNER **tattooing forceps** 10 mm, double row 6 divisions, articulated*



ID-191A Tatuadora rotativa de 5 mm y de 6 caracteres
ID-191B Carácter para tatuadora rotativa de 5 mm

*ID-191A 5 mm and 6 spaces **rotary tattooer**
 ID-191B 5 mm **characters** for rotatory tattooer*



MARTILLOS Y TATUADORAS HAMMERS AND TATTOOING FORCEPS

Casillas lineales Linear rows

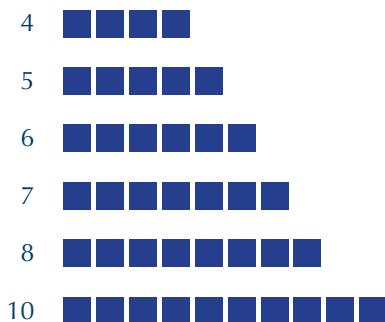

Casillas dobles Double rows

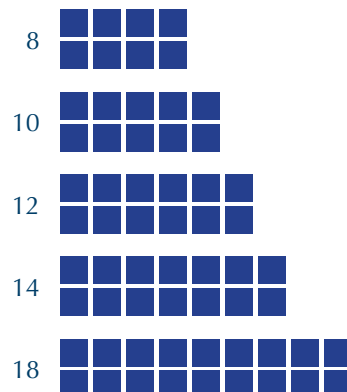

Números y letras para martillo de 20 mm

Numbers and letters for 20 mm tattooing hammer

- | | |
|---|--|
| ID-101 Juego de números | <i>ID-101 Set of numbers</i> |
| ID-101A hasta ID-101J Números sueltos | <i>ID-101A to ID-101J single digits</i> |
| ID-102 Abecedario | <i>ID-102 Complete alphabet</i> |
| ID-102A hasta ID-102Z Letras sueltas | <i>ID-102A to ID-102Z single letters</i> |
| ID-099 Placa lisa | <i>ID-099 Blank plate</i> |



Números y letras para tatuadora de 15 mm

Numbers and letters for 15 mm tattooing forceps

- | | |
|--------------------------------|---------------------------------|
| ID-155 letras | <i>ID-155 Letters</i> |
| ID-175 Números | <i>ID-175 Numbers</i> |
| ID-115 Abecedario | <i>ID-115 Complete alphabet</i> |
| ID-135 Juego de números | <i>ID-135 Set of numbers</i> |



Números y letras para tatuadora de 20 mm

Numbers and letters for 20 mm tattooing forceps

- | | |
|--------------------------------|---------------------------------|
| ID-160 letras | <i>ID-160 Letters</i> |
| ID-180 Números | <i>ID-180 Numbers</i> |
| ID-120 Abecedario | <i>ID-120 Complete alphabet</i> |
| ID-140 Juego de números | <i>ID-140 Set of numbers</i> |



Números y letras para tatuadora de 10 mm

Numbers and letters for 10 mm tattooing forceps

- | | |
|---|--|
| ID-130 Juego de números | <i>ID-130 Set of numbers</i> |
| ID-170A hasta ID-170J Números sueltos | <i>ID-170A to ID-170J single digits</i> |
| ID-110 Abecedario | <i>ID-110 Complete alphabet,</i> |
| ID-150A hasta ID-150Z Letras sueltas | <i>ID-150A to ID-150Z single letters</i> |
| ID-183 Placa lisa | <i>ID-183 Blank plate</i> |



Números y letras para tatuadora de 7 mm

Numbers and letters for 7 mm tattooing forceps

- | | |
|---|--|
| ID-107 Abecedario | <i>ID-107 Complete alphabet</i> |
| ID-147A hasta ID-147Z Letras sueltas | <i>ID-147A to ID-147Z single letters</i> |
| ID-167A hasta ID-167J Números sueltos | <i>ID-167A to ID-167J single digits</i> |
| ID-127 Juego de números | <i>ID-127 Set of numbers</i> |
| ID-184 Placa lisa | <i>ID-184 Blank plate</i> |



Números y letras para tatuadora de 5 mm

Numbers and letters for 5 mm tattooing forceps

- | | |
|---|--|
| ID-106 Abecedario | <i>ID-106 Complete alphabet</i> |
| ID-144A hasta ID-144Z Letras sueltas | <i>ID-144A to ID-144Z single letters</i> |
| ID-166A hasta ID-166J Números sueltos | <i>ID-166A to ID-166J single digits</i> |
| ID-126 Juego de números | <i>ID-126 Set of numbers</i> |



ID-145A hasta **ID-145Z** Letras sueltas de 5 mm para tatuadora de 10 mm

- ID-105** Abecedario de 5 mm para tatuadora de 10 mm
ID-125 Juego de números 5 mm para tatuadora de 10 mm

ID-145A to ID-145Z 5 mm single letters for 10 mm tattooing forceps
ID-105 Complete alphabet, 5 mm for 10 mm tattooing forceps
ID-125 5 mm numbers set for 5 mm tattooing forceps





ID-229 Frasco de tinta verde HAUPTNER, 600 g

ID-230 Frasco de tinta negra HAUPTNER, 600 g

ID-229 HAUPTNER green *tattooing paste pot*, 600 g

ID-230 HAUPTNER black *tattooing paste pot*, 600 g



ID-231 Frasco de tinta negra RAIDEX, 600 g

ID-232 Frasco de tinta verde RAIDEX, 600 g

ID-231 RAIDEX black *tattooing paste pot*, 600 g

ID-232 RAIDEX green *tattooing paste pot*, 600 g



ID-226 Tubo de tinta, sistema bola RAIDEX, negra

ID-226 RAIDEX black *ink tube*, roll-on



ID-225 Tubo de tinta, sistema bola HAUPTNER, negra

ID-225 HAUPTNER black *ink tube*, roll-on



ID-227 Tubo de tinta, sistema bola RAIDEX, verde

ID-227 RAIDEX green *ink tube*, roll-on



Tubo de tinta RAIDEX de 60 g
Tattooing paste tube RAIDEX, 60 g

ID-221 Negra

ID-222 Verde

ID-223 Blanca

ID-221 Black

ID-222 Green

ID-223 White



ID-232A Tinta líquida negra para tatuar HAUPTNER, 1 l

ID-232A HAUPTNER *tattooing fluid ink*, black 1 l



ID-233 Tinta líquida negra para tatuar RAIDEX, 1 l

ID-233 RAIDEX *tattooing fluid ink*, black 1 l



Tubo de tinta HAUPTNER de 60 g.
Tattooing paste tube HAUPTNER 60 g

ID-220 Negra

ID-219 Verde

ID-220 Black

ID-219 Green

Identificación Identification



Tinta alimentaria para marcar carne, 1 l
Meat stamping ink, 1 l

- ID-297** Color rojo
- ID-298** Color azul
- ID-299** Color marrón

- ID-297** Red
- ID-298** Blue
- ID-299** Brown



Tinta alimentaria para marcar carne, 5 l
Meat stamping ink, 5 l

- ID-297A** Color rojo
- ID-297B** Color azul
- ID-298A** Color marrón

- ID-297A** Red
- ID-297B** Blue
- ID-298A** Brown



Tinta alimentaria RAIDEX para marcar carne, 1 l
RAIDEX meat stamping ink, 1 l

- ID-296A** Color rojo
- ID-296B** Color azul
- ID-296** Color marrón

- ID-296A** Red
- ID-296B** Blue
- ID-296** Brown



Tinta alimentaria RAIDEX para marcar carne, 5 l
RAIDEX meat stamping ink, 5 l

- ID-296D** Color rojo
- ID-296E** Color azul
- ID-296C** Color marrón

- ID-296D** Red
- ID-296E** Blue
- ID-296C** Brown



ID-234 Tampón para tinta de números manuales
ID-233T Esponja de recambio para tampón de tinta

- ID-234** Ink pad for manual digits
- ID-233T** Spare sponge for ink pad



ID-299A Tinta para carne decomisada, azul, bidón de 5 l

- ID-299A** SRM blue dye solution, 5 l

NOVEDAD GLOBAL

El único martillo en el mundo con la tinta incorporada

*The only tattoo hammer in the world
with ink cartridge*



Marca un camión con tan solo una carga de tinta

Marks full truck with just one load of ink

WORLD NOVELTY

Identificación
Identification

Marca y tatúa en el mismo instante en que golpea

It tattoos instantly by hammering the animal, easy to use and clean

ID-100 Martillo tatuador INSERFIX con depósito de tinta

ID-100 INSERFIX tattooing hammer with ink tank



Números para martillo tatuador INSERFIX exclusivos
Single digits for INSERFIX tattooing hammer

ID-100A Números de 20 mm
ID-100B Letras de 20 mm
ID-100C Placa en blanco de 20 mm

ID-100A 20 mm single digits
ID-100B 20 mm single letters
ID-100C Blank plate for 20 mm



ID-233C Tinta líquida para tatuar alimentaria marrón, 1 l

ID-233C Tattooing fluid ink - brown (1 l)



ID-233D Tinta líquida para tatuar alimentaria marrón, 5 l

ID-233D Tattooing fluid ink - brown (5 l)



ID-100F Tampón para martillo tatuador INSERFIX, paquete de 10 unidades

ID-100F INSERFIX tattooing hammer pad, pack of 10 units

Lápices para marcar RAIDEX, con rosca (caja de 10 u)

RAIDEX marking sticks, plastic tube with screw bottom

- | | |
|------------------------|----------------------|
| ID-280 Rojo | <i>ID-280 Red</i> |
| ID-281 Azul | <i>ID-281 Blue</i> |
| ID-282 Verde | <i>ID-282 Green</i> |
| ID-283 Amarillo | <i>ID-283 Yellow</i> |
| ID-284 Violeta | <i>ID-284 Violet</i> |
| ID-285 Naranja | <i>ID-285 Orange</i> |
| ID-286 Negro | <i>ID-286 Black</i> |
| ID-287 Blanco | <i>ID-287 White</i> |



Spray para marcar RAIDEX, 400 ml
RAIDEX marking spray, 400 ml

- | | |
|-------------------------|-----------------------|
| ID-250 Rojo | <i>ID-250 Red</i> |
| ID-255 Azul | <i>ID-255 Blue</i> |
| ID-260 Verde | <i>ID-260 Green</i> |
| ID-260A amarillo | <i>ID-260A Yellow</i> |
| ID-260B violeta | <i>ID-260B Violet</i> |

Spray para marcar RAIDEX, 500 ml
RAIDEX marking spray, 500 ml

- | |
|---------------------|
| ID-261 Rojo |
| ID-262 Azul |
| ID-263 Verde |
| ID-264 Negro |

- | |
|---------------------|
| <i>ID-261 Red</i> |
| <i>ID-262 Blue</i> |
| <i>ID-263 Green</i> |
| <i>ID-264 Black</i> |



Spray para marcar ovejas RAIDEX, 500 ml
RAIDEX sheep marking spray, 500 ml

- | | |
|------------------------|-----------------------|
| ID-270 Rojo | <i>ID-270 Red</i> |
| ID-271 Azul | <i>ID-271 Blue</i> |
| ID-272 Verde | <i>ID-272 Green</i> |
| ID-273 Negro | <i>ID-273 Black</i> |
| ID-274 Amarillo | <i>ID-274 Yellow</i> |
| ID-275 Violeta | <i>ID-275 Violet</i> |
| ID-275A Rosa | <i>ID-275A Pink</i> |
| ID-275B Naranja | <i>ID-275B Orange</i> |

Identificación Identification



Lápices para marcar INSERFIX,
con rosca (caja de 12 u.)
INSERFIX marking sticks, plastic tube
with screw bottom

ID-276 Rojo
ID-277 Azul
ID-278 Verde

ID-276 Red
ID-277 Blue
ID-278 Green



ID-269 Pistola para spray de marcar

ID-269 Marking spray applicator



Spray para marcar INSERFIX, 400 ml
INSERFIX marking spray, 400 ml

ID-247 Rojo

ID-248 Azul

ID-249 Verde

ID-249B Negro

ID-249F Amarillo fluorescente

ID-247 Red

ID-248 Blue

ID-249 Green

ID-249B Black

ID-249F Fluorescent yellow

Alargo INSERFIX para sprays de marcar
INSERFIX extension for marking spray

ID-269A 100cm

ID-269B 50cm

ID-269C Realizado a medida

ID-269A 100 cm

ID-269B 50 cm

ID-269C Size by request

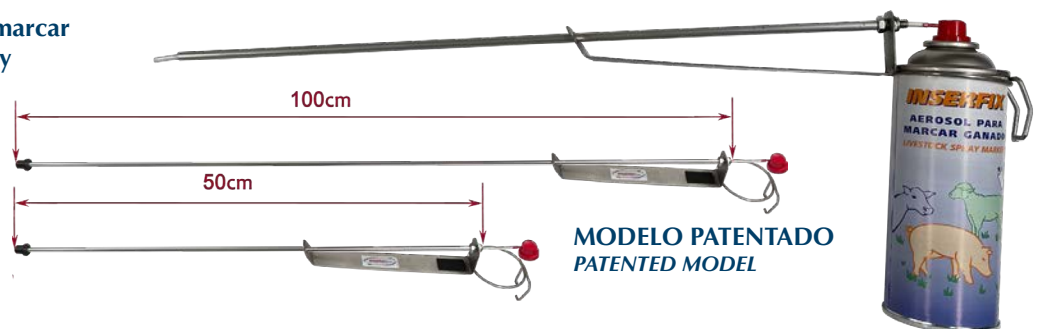

MODELO PATENTADO
PATENTED MODEL



ID-289 Alargo de 1 m para lápices de marcar "lineal"
ID-289A Alargo transversal para lápices de marcar, 1 m

ID-289 Linear extension for markings sticks 1 m

ID-289A Extension for marking sticks, transversal 1 m





Juego de números de aluminio con mango de madera
Set of aluminium numbers with wooden handle

- ID-234A** 8 cm
- ID-234B** 10 cm
- ID-234C** 12 cm



ID-340 Juego de números de bronce de 8 cm para marcar a nitrógeno

ID-340 Set of 8 cm bronze numbers to mark with nitrogen



ID-345 Juego de números para nitrógeno HAUPTNER

ID-345 HAUPTNER set of numbers to mark with nitrogen



Lápiz para marcaje de carne, caja de 12 uds
Meat marking pen, box of 12 units

- ID-299B** Marrón **ID-299B** Brown
- ID-299C** Azul **ID-299C** Blue

Tiza para marcaje Sisa RAIDEX, caja de 12 uds
Sisa RAIDEX marking chalks, box of 12 pcs

- ID-289B** Rojo **ID-289B** Red
- ID-289C** Azul **ID-289C** Blue
- ID-289D** Verde **ID-289D** Green
- ID-289E** Amarillo **ID-289E** Yellow



Identificación Identification



Tinta para marcar ovejas *Sheep marking ink*

ID-234D color rojo de 4 kg
ID-234E color azul de 4 kg
ID-234F color verde de 4 kg

ID-234D 4 kg red
ID-234E 4 kg blue
ID-234F 4 kg green



Pastilla RAIDEX para arnés *RAIDEX harness wax blocks*

ID-290 Rojo *ID-290* Red
ID-291 Azul *ID-291* Blue
ID-292 Verde *ID-292* Green
ID-293 Amarilla *ID-293* Yellow

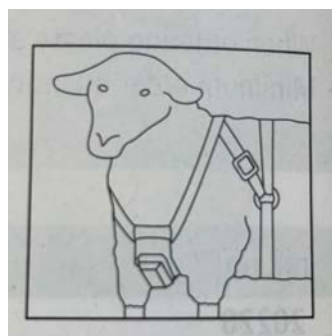
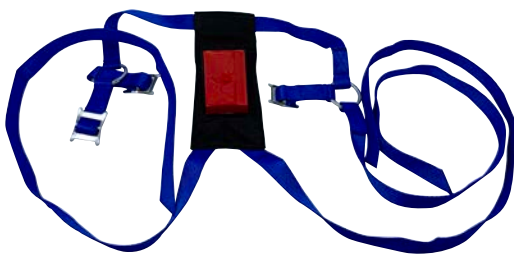

ID-295 Arnés de nailon para marcaje en ovino con pastillas RAIDEX

ID-295 Nylon **harness** for sheep marking
with RAIDEX wax blocks



ID-235 Tenaza sacabocados HAUPTNER

ID-236 Accesorio redondo para tenaza HAUPTNER

ID-235 Ear notcher HAUPTNER

ID-236 Round accessory for HAUPTNER ear notcher



ID-330 Tenaza sacabocados niquelada

ID-330 Nickel-plated ear notcher



ID-305

ID-302

ID-300 Tenaza para aretes Dorital, HAUPTNER

ID-302 Marcas Dorital, HAUPTNER, metálicas remache redondo, paq. de 100 uds

ID-304 Tenaza supercrotal, HAUPTNER, grande y ovalada

ID-305 Aretes supercrotal HAUPTNER, grandes y ovalada, paq de 100 uds

ID-300 HAUPTNER Dorital ear tags applicator

ID-302 HAUPTNER Dorital round tip ear tags, box of 100 pcs

ID-304 HAUPTNER supercrotal ear tags plier

ID-305 HAUPTNER supercrotal ear tags, box of 100 pcs

Identificación Identification



ID-308 Marcas metálicas numeradas para conejos, paq. de 100 uds
ID-309 Marcas metálicas manuales numeradas para conejos, paq. de 100 uds

ID-308 Metallic ear tags for rabbits, numbered. box of 100 units
ID-309 Hand metallic ear tags for rabbits, numbered. box of 100 units

ID-307 Tenaza para marcas de conejos
ID-307 Applicator for rabbits ear tags

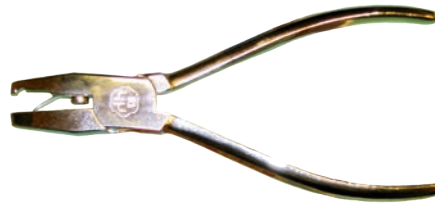

ID-311 Marcas Durafix HAAPTNER, paq. de 100 uds
ID-311 HAAPTNER Durafix ear tags, box of 100 pcs



ID-790 Rotulador para marcas INSEFIX
ID-790 INSEFIX marker for ear tags



ID-660 Tenaza para marcas INSEFIX mini
ID-660 Applicator for Insefix small ear tags



ID-650 Marcas INSEFIX mini, sin numerar
ID-655 Marcas INSEFIX mini, numeradas
ID-656 Marcas INSEFIX mini, numeradas, 2 caras
ID-650 Small INSEFIX ear tags, unnumbered
ID-655 Small INSEFIX ear tags, numbered
ID-656 Small INSEFIX ear tags, numbered, 2 sides



Tamaño real
Real size

Colores disponibles: amarillo, blanco, azul, verde, rojo, salmón y violeta
Available colors: yellow, white, blue, green, red, salmon and violet



Tamaño real
Real size



ID-700 Marcas pala macho pequeña INSERTFIX, sin numerar
ID-705 Marcas pala macho pequeña INSERTFIX, numeradas

ID-700 INSERTFIX small ear tags, male, shovel form, unnumbered
ID-705 INSERTFIX small ear tags, male, shovel form, numbered

ID-710 Marcas INSERTFIX pala hembra pequeña, sin numerar
ID-715 Marcas INSERTFIX pala hembra pequeña, numeradas

ID-710 INSERTFIX small ear tags, female, shovel form, unnumbered
ID-715 INSERTFIX small ear tags, female, shovel form, numbered



Tamaño real
Real size



ID-743 Marcas pala macho grande INSERTFIX, sin numerar
ID-744 Marcas pala macho grande INSERTFIX, numeradas

ID-743 INSERTFIX big ear tags, male, shovel form, unnumbered
ID-744 INSERTFIX big ear tags, male, shovel form, numbered

ID-745 Marcas pala hembra grande INSERTFIX, sin numerar
ID-750 Marcas pala hembra grande INSERTFIX, numeradas

ID-745 INSERTFIX big ear tags, female, shovel form, unnumbered
ID-750 INSERTFIX big ear tags, female, shovel form, numbered



Tamaño real
Real size

ID-755 Marcas pala hembra maxi INSERTFIX, sin numerar
ID-760 Marcas pala hembra maxi INSERTFIX, numeradas

ID-755 INSERTFIX ear tags, female, shovel form, maxi, unnumbered
ID-760 INSERTFIX ear tags, female, shovel form, maxi, numbered

Identificación Identification



ID-775 Tenaza para marcas INSERFIX

ID-775 INSERFIX applicator for ear tags



ID-780 Aguja de recambio para tenaza INSERFIX

*ID-780 Spare **spin** for INSERFIX applicator*



ID-720 Marcas botón hembra INSERFIX, sin numerar

ID-721 Marcas botón hembra INSERFIX, numerada

ID-720 INSERFIX ear tags, female, button form, unnumbered

ID-721 INSERFIX ear tags, female, button form, numbered



Tamaño real
Real size



ID-725 Marcas botón macho con punta de metal INSERFIX, sin numerar

ID-730 Marcas botón macho con punta de metal INSERFIX, numerada

ID-725 INSERFIX ear tags, male, button form with metallic point, unnumbered

ID-730 INSERFIX ear tags, male, button form with metallic point, numbered



Tamaño real
Real size



ID-723 Marca botón macho con punta de metal INSERFIX, "cuello largo"

ID-723 INSERFIX ear tags, male, button form with metallic point, "long neck"



ID-735 Marcas botón macho INSERFIX, con punta de plástico sin numerar

ID-740 Marcas botón macho INSERFIX, con punta de plástico, numerada

ID-735 INSERFIX ear tags, male, button form with plastic point, unnumbered

ID-740 INSERFIX ear tags, male, button form with plastic point, numbered



Tamaño real
Real size



Tamaño real
Real size



- ID-815 Marcas** pala macho INSERTIFIX, júnior, sin numerar
- ID-820 Marcas** pala macho INSERTIFIX, júnior, numeradas
- ID-821 Marcas** pala hembra INSERTIFIX, júnior, sin numerar
- ID-822 Marcas** pala hembra INSERTIFIX, júnior, numeradas

- ID-815 INSERTIFIX ear tags, male, shovel form, junior, unnumbered*
- ID-820 INSERTIFIX ear tags, male, shovel form, junior, numbered*
- ID-821 INSERTIFIX ear tags, female, shovel form, junior, unnumbered*
- ID-822 INSERTIFIX ear tags, female, shovel form, junior, numbered*



Tamaño real
Real size



- ID-800 Marcas** pala hembra INSERTIFIX, sénior, sin numerar
- ID-805 Marcas** pala hembra INSERTIFIX, sénior, numeradas
- ID-810 Marcas** pala hembra INSERTIFIX, sénior, numeradas, dos caras
- ID-811 Marcas** pala macho INSERTIFIX, sénior, sin numerar
- ID-812 Marcas** pala macho INSERTIFIX, sénior, numeradas

- ID-800 INSERTIFIX ear tags, female, shovel form, senior, unnumbered*
- ID-805 INSERTIFIX ear tags, female, shovel form, senior, numbered*
- ID-810 INSERTIFIX ear tags, female, shovel form, senior, numbered, 2 sides*
- ID-811 INSERTIFIX ear tags, male, shovel form, senior, unnumbered*
- ID-812 INSERTIFIX ear tags, male, shovel form, senior, numbered*



Disponemos de crotales electrónicos y lectores

Electronic ear tags and readers available



ID-829 Marcas INSERTFIX conjunto mini oficial, paq. 10 uds

ID-829A Marcas INSERTFIX conjunto mini oficial

“numerado”, paq. 10 uds

ID-829B Marcas INSERTFIX conjunto mini oficial “numerado

2 caras”, paq. 10 uds

ID-829 INSERTFIX mini official eartags, bag of 10 pcs

ID-829A INSERTFIX mini official eartags numbered, bag of 10 pcs

ID-829B INSERTFIX mini official eartags numbered 2 sides, bag of 10 pcs

Identificación Identification

Marcas pala mini INSERTFIX cerrada INSERTFIX closed mini ear tags



ID-824 Pala hembra mini INSERTFIX paq. 100 uds

ID-824N Pala hembra mini INSERTFIX, numeradas paq. 100 uds

ID-828 Pala macho mini INSERTFIX paq. 100 uds

ID-828N Pala macho mini INSERTFIX, paq. 100 uds numerada

ID-824 INSERTFIX mini female ear tags, shovel form, bag of 100 pcs

ID-824N INSERTFIX mini female ear tags, shovel form, bag of 100 pcs, numbered

ID-828 INSERTFIX mini male ear tags, shovel form, bag of 100 pcs

ID-828N INSERTFIX mini male ear tags, shovel form, bag of 100 pcs, numbered

Tamaño real Real size



ID-827 Marcas pala hembra INSERTFIX, grande cerrada, sin numerar, paq. 100 uds

ID-827N Marcas pala hembra INSERTFIX, grande cerrada, numerada, paq. 100 uds

ID-827 INSERTFIX big female ear tags, shovel form, closed model, unnumbered, bag of 100 pcs

ID-827N INSERTFIX big female ear tags, shovel form, closed model, numbered, bag of 100 pcs



ID-826 Marcas pala hembra INSERTFIX, mediana cerrada, sin numerar, paq. 100 uds

ID-826N Marcas pala hembra INSERTFIX, mediana cerrada, numerada, paq. 100 uds

ID-826 INSERTFIX medium female ear tags, shovel form, closed model, unnumbered, bag of 100 pcs

ID-826N INSERTFIX medium female ear tags, shovel form, closed model, numbered, bag of 100 pcs



ID-823 Marcas botón hembra cerrada INSERTFIX, sin numerar, paq. 100

ID-823 INSERTFIX closed button female ear tags, unnumbered, bag of 100 pcs



ID-825 Marcas pala hembra INSERTFIX, pequeña cerrada, sin numerar, paq. 100 uds

ID-825N Marcas pala hembra INSERTFIX, pequeña cerrada, numerada, paq. 100 uds

ID-825 INSERTFIX small female ear tags, shovel form, closed model, unnumbered, bag of 100 pcs

ID-825N INSERTFIX small female ear tags, shovel form, closed model, numbered, bag of 100 pcs



ID-695 Marcas para colgar INSERTIFIX
ID-696 Marcas para colgar INSERTIFIX, numeradas

ID-695 INSERTIFIX neck tags
ID-696 INSERTIFIX neck tags, numbered

Tamaño real
Real size



ID-790 Rotulador para marcas INSERTIFIX

ID-790 INSERTIFIX marker for ear tags



ID-795 Rotulador ALLFLEX Tag-Pen con dos puntas

ID-795 ALLFLEX Tag-pen marker (2 tips)

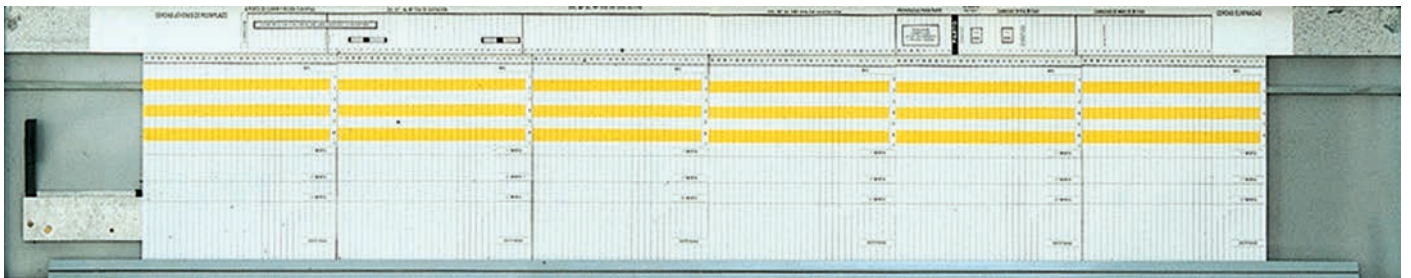

II-100 Planning completo para control de granjas

II-100 Complete planning for farm control



II-110 Imanes cuadrados para planning. Colores: amarillo, azul, rojo y verde, paq. de 100 uds

II-110 Magnets for planning. Different colours: yellow, blue, red and green, 100 units bag

II-130 Imanes redondos para planning. Colores: amarillo, azul, rojo y verde, paq. de 100 uds

II-130 Rounded magnets for planning. Different colours: yellow, blue, red and green, 100 units bag

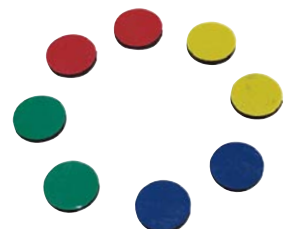





ID-620 Tenaza ALLFLEX
ID-625 Aguja de recambio ALLFLEX

ID-620 ALLFLEX ear tags applicator
ID-625 ALLFLEX spare spin



ID-600 Marcas botón macho ALLFLEX
ID-601 Marcas botón macho ALLFLEX, numeradas

ID-600 ALLFLEX round male ear tags
ID-601 ALLFLEX round male ear tags, numbered

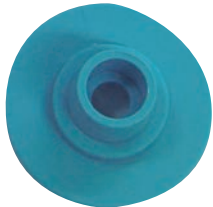

ID-605 Marcas botón hembra ALLFLEX
ID-604 Marcas botón hembra ALLFLEX, numeradas

ID-605 ALLFLEX round female ear tags
ID-604 ALLFLEX round female ear tags, numbered



ID-602 Marcas botón macho cuello largo ALLFLEX

ID-602 ALLFLEX round male ear tags, long neck



ID-615 Marcas pala hembra ALLFLEX, mediana, sin numerar
ID-616 Marcas pala hembra ALLFLEX, mediana, numeradas

ID-615 ALLFLEX medium female ear tags, unnumb.
ID-616 ALLFLEX medium female ear tags, numbered



ID-610 Marcas ALLFLEX pala macho, mediana, sin numerar
ID-611 Marcas ALLFLEX pala macho, mediana, numeradas

ID-610 ALLFLEX medium male ear tags, unnumb.
ID-611 ALLFLEX medium male ear tags, numbered

Colores disponibles: amarillo, azul, blanco, rojo y verde.
Todas las marcas están a tamaño real

Available colours: Yellow, blue, white, red and green
All ear-tags are actual size

Identificación Identification

ID-630 Marcas pala hembra ALLFLEX, júnior, sin numerar
ID-630A Marcas pala hembra ALLFLEX, júnior, numeradas

ID-630 ALLFLEX junior female ear tags, unnumb.
ID-630A ALLFLEX junior female ear tags, numbered



ID-631 Marcas ALLFLEX pala macho, júnior, sin numerar
ID-631A Marcas ALLFLEX pala macho, júnior numeradas

ID-631 ALLFLEX junior male ear tags, unnumb.
ID-631A ALLFLEX junior male ear tags, numbered



ID-618 Marcas ALLFLEX pala hembra, maxi, sin numerar
ID-619 Marcas ALLFLEX pala hembra, maxi, numerada

ID-618 ALLFLEX maxi female ear tags, unnumb.
ID-619 ALLFLEX maxi female ear tags, numbered



ID-636 Marcas ALLFLEX pala macho, pentag
ID-637 Marcas ALLFLEX pala hembra, pentag

ID-636 ALLFLEX male ear tags, pentag
ID-637 ALLFLEX female ear tags, pentag



ID-603 Marcas ALLFLEX botón hembra, electrónico FDX

ID-603 ALLFLEX round female ear tags, FDX electronic



ID-634 Marcas ALLFLEX pala hembra, sénior, sin numerar
ID-635 Marcas ALLFLEX pala hembra, sénior, numerada

ID-634 ALLFLEX senior female ear tags, unnumb.
ID-635 ALLFLEX senior female ear tags, numbered



ID-632 Marcas ALLFLEX pala macho, sénior, sin numerar
ID-633 Marcas ALLFLEX pala macho, sénior, numerada

ID-632 ALLFLEX senior male ear tags, unnumb.
ID-633 ALLFLEX senior male ear tags, numbered



ID-623 Cuchillo cúter cortador de crotales ALLFLEX

ID-623 ALLFLEX ear tag cutter



ID-623A Cuchillo cúter cortador de crotales

ID-623A Ear tag cutter



ID-785 Tenaza para marcas INSERTIFX con aguja basculante

ID-785 INSERTIFX applicator for ear tags with tilting needle



ID-621 Aplicador ALLFLEX, automático

ID-621 ALLFLEX automatic applicator



ID-795 Rotulador ALLFLEX Tag Pen, doble con dos puntas

ID-795 ALLFLEX tag pen *marker* (two tips)



ID-622 Tenaza para crotales universal

ID-622 Universal *applicator* for ear tags



ID-625A Aguja de recambio para tenaza universal

ID-625A Spare *spin* for universal applicator



ID-782 Tenaza para marcas "automática" INSERFIX a baterías

ID-782 INSERFIX *battery powered ear tag plier*



ID-596 Lector ALLFLEX tipo espada AWR300

ID-596 ALLFLEX *sword type reader* AWR300



ID-597 Lector ALLFLEX tipo espada AWR250

ID-597 ALLFLEX *sword type reader* AWR250



ID-575 Tenaza ALLFLEX aplicadora TST muestras de tejidos
ID-570 Marcas ALLFLEX kit TST para muestras de tejidos BOT+BOT

ID-575 ALLFLEX *tissue sampling TST tag applicator*

ID-570 *Ear tags ALLFLEX kit for tissue sampling BOT+BOT*



ID-786 Lector INSERFIX para crotales ISO11784, FDX-B, ID64, HDX

ID-786 INSERFIX *reader for ear tags ISO11784, FDX-B, ID64, HDX*

Precinto de plástico
Plastic seal

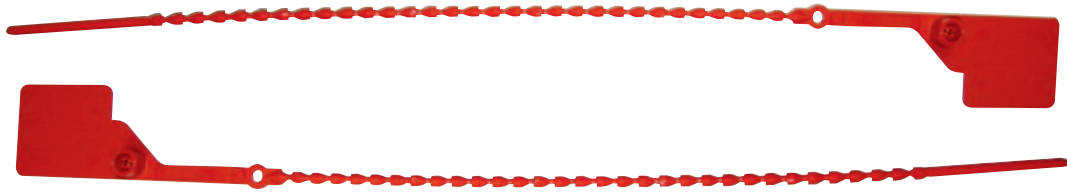

- ID-874** N°4 sin numerar, paq. 1.000 uds
- ID-875** N°4 numerado o solo grabación, paq. 1.000 uds
- ID-876** N°4 solo grabación, paq. 1.000 uds
- ID-877** N°4 numerado y grabado, paq. 1.000 uds

- ID-874** N.4 unnumbered (bag of 1,000 pcs)
- ID-875** N.4 numbered or printed (bag of 1,000 pcs)
- ID-876** N.4 only printed (bag of 1,000 pcs)
- ID-877** N.4 numbered and printed (bag of 1,000 pcs)



Tamaño real
Real size

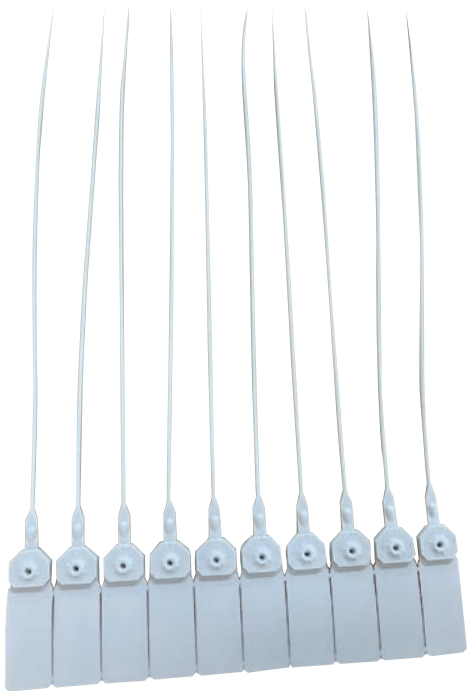

- ID-880** Precinto de plástico sin numerar color blanco
- ID-880** *White unnumbered plastic seal*



- ID-830** Anillas para aves con clip, paq. de 100 (diámetro 8 mm)
- ID-830** *Bird rings with clip, pack of 100 units (diameter 8 mm)*

Identificación Identification



Collares de plástico para ovejas
Plastic collars for sheep

ID-850 Azul claro	ID-850 Light blue
ID-850A Azul oscuro	ID-850A Dark blue
ID-851 Amarillo	ID-851 Yellow
ID-852 Rojo	ID-852 Red
ID-853 Verde claro	ID-853 Light green
ID-853A Verde oscuro	ID-853A Dark green
ID-854 Naranja	ID-854 Orange
ID-855 Negro	ID-855 Black
ID-856 Blanco	ID-856 White



Pulseras de plástico para identificación de vacuno
Plastic bracelets for cattle identification

ID-865 Amarillo	ID-865 Yellow
ID-866 Rojo	ID-866 Red
ID-867 Azul	ID-867 Blue
ID-868 Verde	ID-868 Green
ID-869 Naranja	ID-869 Orange



Cinta nailon con velcro para vacuno, paq. de 10 uds
Nylon tape with velcro for cattle, pack of 10 units

ID-860 Verde	ID-860 Green
ID-861 Amarillo	ID-861 Yellow
ID-862 Rojo	ID-862 Red
ID-863 Azul	ID-863 Blue





- IL-300 Bombilla** de infrarrojos cristal duro INERBO, 100 W, roja
- IL-305 Bombilla** de infrarrojos cristal duro INERBO, de 150 W, roja
- IL-310 Bombilla** de infrarrojos cristal duro INERBO, de 175 W, roja

*IL-300 Hard glass INERBO 100 W. infrared **bulb**, red*
*IL-305 Hard glass INERBO 150 W. infrared **bulb**, red*
*IL-310 Hard glass INERBO 175 W. infrared **bulb**, red*

- IL-320 Bombilla** de infrarrojos cristal duro INERBO, de 100 W, blanca
- IL-325 Bombilla** de infrarrojos cristal duro INERBO, de 150 W, blanca
- IL-330 Bombilla** de infrarrojos cristal duro INERBO, de 175 W, blanca

*IL-320 Hard glass INERBO 100 W. infrared **bulb**, clear*
*IL-325 Hard glass INERBO 150 W. infrared **bulb**, clear*
*IL-330 Hard glass INERBO 175 W. infrared **bulb**, clear*



- IL-245 Bombilla** de infrarrojos INERBO, de 100 W, roja
- IL-250 Bombilla** de infrarrojos INERBO, de 150 W, roja
- IL-255 Bombilla** de infrarrojos INERBO, de 175 W, roja
- IL-260 Bombilla** de infrarrojos INERBO, de 250 W, roja

*IL-245 100 W. INERBO infrared **bulb**, red*
*IL-250 150 W. INERBO infrared **bulb**, red*
*IL-255 175 W. INERBO infrared **bulb**, red*
*IL-260 250 W. INERBO infrared **bulb**, red*

- IL-265 Bombilla** de infrarrojos INERBO, de 150 W, blanca
- IL-270 Bombilla** de infrarrojos INERBO, de 175 W, blanca
- IL-275 Bombilla** de infrarrojos INERBO, de 250 W, blanca

*IL-265 150 W. INERBO infrared **bulb**, clear*
*IL-270 175 W. INERBO infrared **bulb**, clear*
*IL-275 250 W. INERBO infrared **bulb**, clear*



Bombilla de infrarrojos PHILIPS PHILIPS Infrared bulb



IL-130 De 150 W, roja
IL-135 De 250 W, roja

IL-130 150 W. red
IL-135 250 W. red



IL-138 De 100 W, roja, cristal duro
IL-140 De 175 W, roja, cristal duro

IL-138 100 W. red, hard glass
IL-140 175 W. red, hard glass



IL-141 De 175 W, blanca, cristal duro

IL-141 175 W. clear, hard glass

Lámpara protectora de bombilla infrarrojos, con cadena y economizador
Infrared lamp holder; supplied with chain and economiser



IL-125 Cable de 2,5 m
IL-126 Cable de 5 m
IL-101 Cable de 2,5 m, caja de 10 uds. (sin montar)
IL-103 Cable de 5 m, caja de 10 uds. (sin montar)

IL-125 2.5 m cord
IL-126 5 m cord
IL-101 2.5 m cord, box of 10 units (unmounted)
IL-103 5 m cord, box of 10 units (unmounted)

Lámpara protectora de bombilla de infrarrojos con cadena
Infrared lamp holder; supplied with chain



IL-120 Cable de 2,5 m
IL-121 Cable de 5 m
IL-100 Cable de 2,5 m, caja de 10 uds. (sin montar)
IL-102 Cable de 5 m, caja de 10 uds. (sin montar)

IL-120 2.5 m cord
IL-121 5 m cord
IL-100 2.5 m cord, box of 10 units (unmounted)
IL-102 5 m cord, box of 10 units (unmounted)

Bombilla de infrarrojos INTERHEAT roja
Red INTERHEAT infrared bulb



IL-195 De 100 W
IL-200 De 150 W
IL-205 De 175 W
IL-210 De 250 W

IL-195 100 W
IL-200 150 W
IL-205 175 W
IL-210 250 W

Bombilla de infrarrojos INTERHEAT blanca
Clear INTERHEAT infrared bulb



IL-215 De 150 W
IL-220 De 175 W
IL-225 De 250 W

IL-215 150 W
IL-220 175 W
IL-225 250 W



IL-115 Portalámparas para bombillas infrarrojas con cable de 3 m
IL-117 Portalámparas para bombillas infrarrojas con cable de 2,5 m y economizador

IL-115 Infrared bulbs lamp holder with 3 m cable
IL-117 Infrared bulbs lamp holder with 2.5 m cable and economizer



NUEVO SISTEMA DE CALEFACCIÓN CON REFLECTORES Y BOMBILLAS DE CUARZO

New heating system with reflectors and quartz bulbs

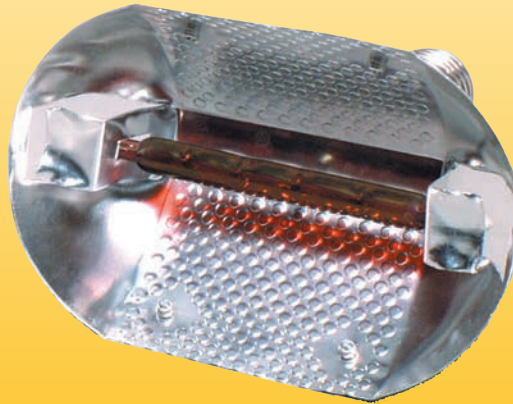

IL-175 Reflector de cuarzo rojo de 250 W
IL-180 Reflector de cuarzo rojo de 175 W

IL-175 Quartz reflector, red, 250 W.
IL-180 Quartz reflector, red, 175 W.

Excepcionales, de alta calidad.
 Muy fuertes y robustos.
 Resistentes a choques.
 De larga duración: tienen una duración de 10.000 horas, nunca experimentada antes.
 Resistentes a salpicaduras de agua.

Exceptional high quality.
Very strong and robust.
Crash resistant.
Long life: about 10,000 hours, never experienced before.

No se funde al salpicar con un spray de agua o de desinfectante, cuando la bombilla está en funcionamiento.

It doesn't fuse when splashed with water spray or disinfectant while the bulb is on.



REFLECTORES DE CUARZO

Quartz reflectors

IL-185 Reflector de cuarzo blanco de 250 W
IL-190 Reflector de cuarzo blanco de 175 W

IL-185 Quartz reflector, clear, 250 W.
IL-190 Quartz reflector, clear, 175 W.



SE ADAPTAN A LOS PORTALÁMPARAS TRADICIONALES
 Ref. **IL-120, IL-121, IL-125 y IL-126**

To adapt on traditional lamp holders
 Ref. **IL-120, IL-121, IL-125 and IL-126**



Reflectores Reflectors

- Se utiliza con las bombillas de cuarzo.
- Ideal para porcino, avicultura, cunicultura, etc.
- Tiene un interruptor para economizar energía de tres posiciones: parado, 50% de potencia y 100% de potencia, según se desee dar más o menos calor o ahorrar en consumo eléctrico.
- Muy fuertes y robustas, resistentes a choques.
- No se funden al salpicar con agua, cuando está en funcionamiento.
- Larga duración: pruebas de laboratorio certifican una duración de vida de 10.000 horas.
- Se suministra con cable de 2,5 metros y rejilla protectora.
- Fabricada en aluminio y acero Inox.
- Cumple las normas de la CE.

- Used with quartz bulbs.
- Suitable for pig, poultry, rabbit breeding etc...
- Three positions economiser switch: off, 50% power, 100% power, depending on how much heat you want or if you wish to save electricity.
- Very strong and robust. Crash resistant.
- They don't fuse when splashed with water while the bulb is on.
- Long life: laboratory tests certify 10,000 hours of life.
- Supplied with a 2.5 m. cable and a protecting grille.
- Made of aluminium and stainless steel.
- They follow the CE rules.

PORTALÁMPARAS CON ECONOMIZADOR PARA BOMBILLAS DE CUARZO *Quartz bulb economiser lamp-holder*



IL-150 Portalámparas con economizador para bombillas de cuarzo

IL-150 Lamp holder for quartz bulbs with economiser

ALTO EFECTO BIOLÓGICO

Por otra parte, la calefacción con bombilla de cuarzo permite un mejor reparto del calor en todo el cuerpo del animal, mejorando la circulación sanguínea y aumentando el confort del animal.

High biological effect:

quartz bulb allows a better spreading of heat on the animal body: improving blood circulation and comfort.

BOMBILLA DE CUARZO *Quartz bulb*



Bombilla de cuarzo
Quartz bulb

IL-155 Roja de 250 W

IL-160 Roja de 175 W

IL-165 Blanca de 175 W

IL-170 Blanca de 250 W

IL-155 Red, 250 W.

IL-160 Red, 175 W.

IL-165 Clear, 175 W.

IL-170 Clear, 250 W.



Bombilla de cuarzo roja INSERBO
INSERBO red quartz bulb

IL-155A De 250 W

IL-160A De 175 W

IL-155A 250 W.

IL-160A 175 W.



IN-120 Lazo para coger cerdos

IN-120 Pig holder

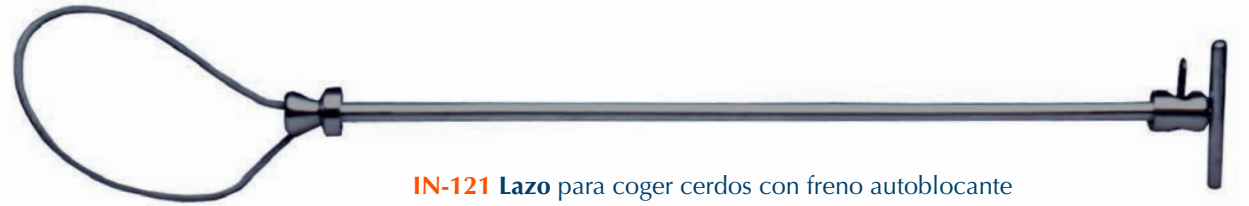

IN-121 Lazo para coger cerdos con freno autoblocante

IN-121 Pig holder with self locking device

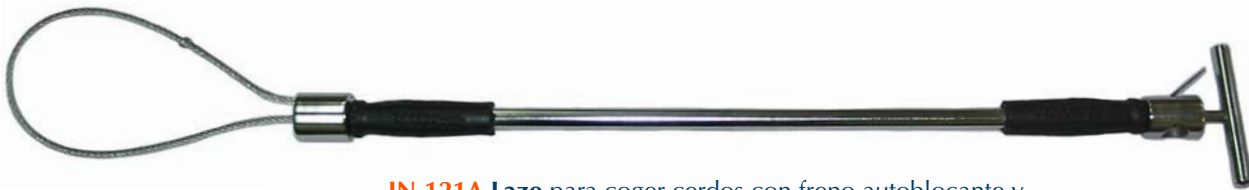

IN-121A Lazo para coger cerdos con freno autoblocante y mandos antideslizamiento

IN-121A Pig holder with self locking device and anti slippery handle



IN-121B Lazo para coger cerdos "extra grueso"

IN-121B "Extra thick" pig holder

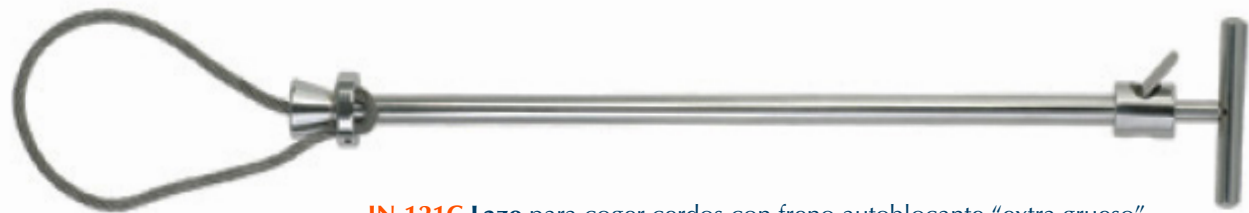

IN-121C Lazo para coger cerdos con freno autoblocante "extra grueso"

IN-121C Pig holder with self locking device "extra thick"



IN-121X Lazo para coger cerdos con mango corto

IN-121X Pig holder with short handle

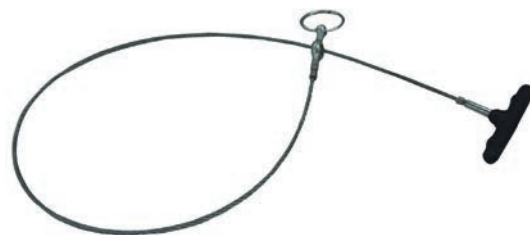

IN-122 Lazo para coger cerdos sin tubo

IN-122 Pig holder without tube

Lazos / Empujadores / Tableros Pig holders / Coaxers / Sorting panels



IN-147BA Pala arreadora sonajera flexible

IN-147BA Flexible rattle paddle



IN-147C Pala arreadora "corta" para empujar ganado

IN-147C "Short" paddle for livestock handling



Tablero para arrear ganado **INSERBO**
INSERBO sorting board for livestock handling

IN-147A 76 x 96 cm

IN-147D 76 x 49 cm

IN-147F 76 x 120 cm



IN-147 Pala arreadora sonajera para empujar el ganado

IN-147 Rattle paddle for livestock handling



IN-136A Empujador KAWE 21 (por impulsos)

IN-136A KAWE 21 impulse coaxer



IN-130 Empujador eléctrico HAUPTNER

IN-130 HAUPTNER electrical coaxer



IN-135 Empujador eléctrico TORERO

IN-135 TORERO electrical coaxer

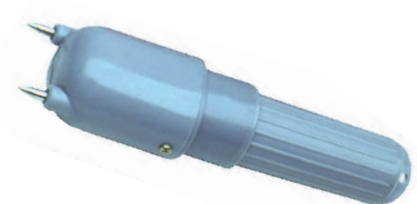

IN-136 Empujador eléctrico KAWE

IN-136 KAWE electrical coaxer



IN-137 Alargo para empujador KAWE

IN-137 KAWE shaft

IN-166 Empujador MAGIC SHOCK azul con alargo de 55 cm

IN-166 MAGIC SHOCK blue coaxer with 55 cm shaft

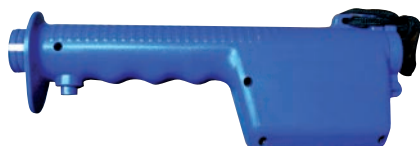

Alargos flexibles
Flexible shaft

IN-175 30 cm

IN-176 55 cm

IN-177 65 cm

IN-178 80 cm

IN-179 106 cm

IN-165 Empujador MAGIC SHOCK azul sin alargo

IN-165 MAGIC SHOCK blue coaxer without shaft

IN-186 Empujador eléctrico recargable STARVET-SHOCK con alargo de 58 cm

IN-187 Empujador eléctrico recargable STARVET-SHOCK con alargo de 84 cm

IN-186 STARVET-SHOCK rechargeable coaxer with 58 cm shaft

IN-187 STARVET-SHOCK rechargeable coaxer with 84 cm shaft

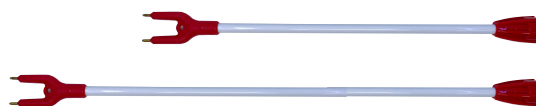

Alargos STARVET-SHOCK
STARVET-SHOCK shaft

IN-190 33 cm

IN-191 58 cm

IN-192 71 cm

IN-193 84 cm

IN-194 109 cm

IN-190 33 cm

IN-191 58 cm

IN-192 71 cm

IN-193 84 cm

IN-194 109 cm

IN-185 Empujador eléctrico recargable STARVET-SHOCK

IN-185 STARVET-SHOCK rechargeable coaxer



IN-196 Baterías recambio empujador STARVET-SHOCK

IN-197 Cargador coche para empujador STARVET-SHOCK

IN-196 STARVET-SHOCK spare battery

IN-197 Car charger for STARVET-SHOCK coaxer



IN-180 Empujador MAGIC SHOCK corto

IN-180 MAGIC SHOCK short coaxer



IN-181 Funda de piel para empujador IN-180

IN-181 Leather cover for IN-180 coaxer



IN-144BA Paq. de 2 pilas alcalinas LR14 de 1,5 V

IN-144BA 2 alkaline LR14 1.5 V batteries pack





IP-161 Protector de hombros

IP-161 Shoulder protection



IP-150 Bata para partos de 130 cm de largo

IP-151 Bata para partos de 140 cm de largo

IP-150 Obstetric coat, 130 cm long

IP-151 Obstetric coat, 140 cm long



Mono para partos
Obstetric overall

- IP-145** Pequeña *IP-145 Small*
- IP-146** Mediana *IP-146 Medium*
- IP-147** Grande *IP-147 Large*



Chaqueta para partos
Obstetric jacket

- IP-160** Talla pequeña
- IP-160A** Talla mediana
- IP-160B** Talla grande

IP-160 Small size
IP-160A Medium size
IP-160B Large size

Pantalón para partos
Obstetric trousers

- IP-155** Talla pequeña
- IP-156** Talla mediana
- IP-157** Talla grande

IP-155 Small size
IP-156 Medium size
IP-157 Large size



IP-162 Delantal para partos de 120 cm de largo (verde)

IP-162 Obstetric long apron, 120 cm (green)



Mono desechable con capucha, azul
Blue disposable overall with hood

IP-124A Talla L / Size L

IP-125A Talla XL / Size XL

IP-126B Talla XXL / Size XXL

IP-125C Talla XXXL / Size XXXL

IP-126C Mono desechable con capucha,
verde, talla XXL

IP-126C Green *disposable overall with hood,*
size XXL



Mono desechable con capucha, blanco
White disposable overall with hood

IP-124 Talla L / Size L

IP-125 Talla XL / Size XL

IP-126A Talla XXL / Size XXL

IP-126 Talla XXXL / Size XXXL

IP-127 Mono desechable plastificado
con capucha, blanco, talla XL

IP-127 White *plasticized overall with hood,*
size XL

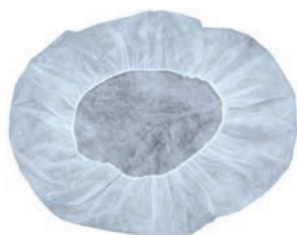

IP-104 Gorro desechable, paq. de 100 uds

IP-104A Gorro desechable azul, paq. de 100 uds

IP-104 Disposable *cap, bag with 100 pcs*

IP-104A Blue disposable *cap, bag with 100 pcs*



IP-122 Mono desechable plastificado sin capucha, talla XL

IP-122A Mono desechable plastificado sin capucha, verde, talla XL

IP-123 Mono desechable sin capucha, blanco, talla XL

IP-123A Mono desechable sin capucha, azul, talla XL

IP-122 *Plasticized overall without hood, size XL*

IP-122A *Plasticized overall without hood, green, size XL*

IP-123 *White disposable overall without hood, size XL*

IP-123A *Blue disposable overall without hood, size XL*



IP-099 Bata de plástico cerrada transparente, desechable, paq. de 20 uds

IP-099 Disposable closed **plastic coat**, transparent. Bag with 20 pcs



IP-100 Bata de plástico desechable cerrada, verde, paq. de 20 uds.

IP-103 Bata desechable verde cerrada "plegada individual", paq. de 20 uds

IP-100 Disposable green closed **plastic coat**, bag with 20 pcs

IP-103 Individually folded green closed **coat**, bag with 20 pcs



IP-120 Bata de tela desechable, con bolsillo para visitas en granja

IP-120 Disposable **cloth coat** with pocket for visits



IP-103C Bata de plástico desechable con capucha. paq. 100

IP-103C Disposable plastic **gown** with hood, pack of 100

Delantal de plástico desechable
Disposable **plastic apron**

IP-108 Blanco, paq. de 100

IP-108A Azul, paq. de 100

IP-108 White, pack of 100

IP-108A Blue, pack of 100



IP-119H Mascarilla quirúrgica (tipo IIR) paq. 50 uds

IP-119HA Mascarilla quirúrgica (tipo I) paq. 50 uds, uso no médico

IP-119H Surgical **mask** (type IIR) 50 units

IP-119HA Surgical **mask** (type I) 50 units, non-medical use



IP-119 Mascarilla desechable, con refuerzo, paq. de 50 uds

IP-119 Disposable surgical **mask** with additional reinforcement, bag with 50 pcs



IP-119CC Mascarilla plegable JSP FFP2 con válvula, paq. de 10 uds

IP-119CC JSP FFP2 folding **mask** with valve, pack. of 10 pcs



IP-119DA Mascarilla FFP2 color negro, paq. de 1 ud

IP-119DA Black FFP2 **mask**, bag with 1 pc

IP-119D Mascarilla FFP2 color blanco, paq. de 1 ud

IP-119D White FFP2 **mask**, bag with 1 pc





IP-110 Botas altas sujetables verdes, paq. de 100 uds

IP-110 Green **overboots** with laces, bag with 100 pcs



IP-111 Botas altas desechables, con goma para sujetar, paq. de 50 uds

IP-111 Disposable **overboots** (with elastic band) bag with 50 pcs

Mono desechable con capucha "GRUESO" protección química
Disposable overall with hood "THICK" chemical protection

IP-129C Talla - Size M
IP-129D Talla - Size L
IP-129E Talla - Size XL
IP-130 Talla - Size XXL

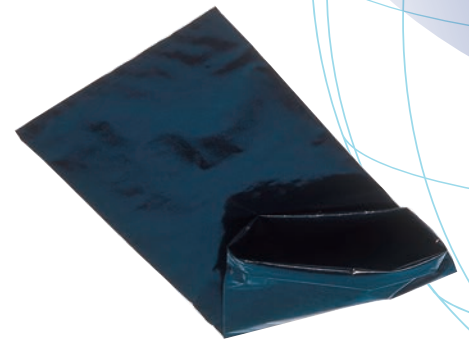

IP-112 Bolsas para pies negras, paq. de 875 uds

IP-112 Black plastic **bags for shoes**, bag with 875 units



Cubrepies con goma para sujetar
Overshoes with elastic band

IP-115 Paq. de 100 uds
IP-115B Paq. de 100 uds, gruesos-gofrado

IP-115 100 units package
IP-115B Thick, embossed, 100 units package



IP-102 Pantalón desechable plegado individual, paq. de 20 uds

IP-102 Disposable **trousers**. individually folded, bag with 20 units



IP-116 Cubrepies blanco PP de 30gr con goma, paq. de 100 unids

IP-116 30g white PP **overshoes** with elastic band, pack of 100 units



IP-116A Cubrepies PP azul antideslizante de 30gr con goma, paq. de 100 unids

IP-116A 30g blue non-slip PP **overshoes** with elastic band, pack of 100 units



IP-547 Mascarilla 3M FFP1 con válvula, paq. 10 uds

IP-547 3M FFP1 mask with valve, bag with 10 units



IP-550 Mascarilla 3M FFP2 con válvula, paq. 10 uds

IP-550 3M FFP2 mask with valve, bag with 10 units



IP-545 Mascarilla 3M FFP1 plegable con válvula, paq. 10 uds

IP-545 3M FFP1 foldable mask with valve, bag with 10 units



IP-555 Mascarilla 3M para gases y vapores

IP-557 Mascarilla 3M para gases y vapores, especial amoníaco

IP-555 3M mask for gases and vapors

IP-557 3M mask for gases and vapors, especially ammonia



IP-568 Gafas de protección 3M ergonómica solar

IP-568 3M ergonomic solar safety glasses



IP-570 Gafas de protección 3M antiempañamiento

IP-570 3M anti-fog safety glasses



IP-565 Gafas de protección 3M visita, cubregafas

IP-565 3M visit safety glasses, goggles



IP-567 Gafas de protección 3M ergonómica incolora

IP-567 Colorless ergonomic 3M safety glasses



IP-571 Clip portales 3M para gafas graduadas

IP-571 3M lens holder clip for prescription glasses



IP-579 Cascos para protección auditiva 3M, Peltor Optime

IP-579 3M Peltor Optime hearing protection helmets



IP-585 Cascos para protección oídos 3M, con audición de voz Protac III

IP-585 3M hearing protection helmets, with Protac III voice hearing



IP-575 Tapones para oídos 3M con cordón ultrafit

IP-575 3M Ultrafit corded ear plugs



IP-577 Tapones para oídos 3M con banda

IP-577 3M banded ear plugs

Camisetas ESPABITE ESPABITE Tshirts



IP-850 hasta **IP-854** Blanca, tallas S hasta XXL

IP-850 White, size S to XXL



IP-856 hasta **IP-860** Verde, tallas S hasta XXL

IP-856 Green, size S to XXL



IP-862 hasta **IP-867** Azul, tallas S hasta XXXL

IP-862 Blue, size S to XXL

Guantes de trabajo de precisión nylon recubrimiento nitrilo Precision work gloves nylon coating nitrile

- | | |
|-------------------------------|------------------------------|
| IP-535B Talla 7 (S) | IP-535B Size 7 (S) |
| IP-535C Talla 8 (M) | IP-535C Size 8 (M) |
| IP-535D Talla 9 (L) | IP-535D Size 9 (L) |
| IP-535E Talla 10 (XL) | IP-535E Size 10 (XL) |
| IP-535F Talla 11 (XXL) | IP-535F Size 11 (XXL) |



Guantes de látex, paquete de 100 unds STARVET latex gloves, 100 units box



- | | |
|------------------------|-----------------------|
| Con polvo | With powder |
| IP-295 Talla XL | IP-295 Size XL |
| IP-300 Talla L | IP-300 Size L |
| IP-305 Talla M | IP-305 Size M |
| IP-310 Talla S | IP-310 Size S |



- | | |
|-----------------------|----------------------|
| Sin polvo | Powder free |
| IP-375 Talla L | IP-375 Size L |
| IP-380 Talla M | IP-380 Size M |
| IP-385 Talla S | IP-385 Size S |

Guantes de vinilo, paquete 100 unds STARVET vinyl gloves, 100 units box



- Con polvo**
IP-400 Talla L
IP-405 Talla M
IP-410 Talla S

- With powder**
IP-400 Size L
IP-405 Size M
IP-410 Size S

- | | |
|------------------------|-----------------------|
| Sin polvo | Powder free |
| IP-420 Talla XL | IP-420 Size XL |
| IP-425 Talla L | IP-425 Size L |
| IP-430 Talla M | IP-430 Size M |
| IP-435 Talla S | IP-435 Size S |



DS-415 Dosificador de jabón y gel automático por infrarrojos

DS-415 Automatic infrared soap and gel dispenser



IP-135A Guantes desechables de plástico, ancho especial, paquete 100 unds

IP-135A Disposable plastic gloves, special width, 100 units bag



DS-410 Gel solución hidoalcohólica SERBONET, 5 l

DS-410 SERBONET hydroalcoholic solution gel, 5 l



DS-420 Dosificador de jabón manual

DS-420 Manual soap dispenser



IP-140 Manguitos de poliéster de 40 cm (el par)

IP-140 Oversleeves polyester 40 cm (in pairs)

Guantes / Higiene Gloves / Hygiene



Guantes de nitrilo negros (3.5gr) sin polvo, paq. 100 unds.

Black nitrile gloves (3.5gr) Powder free, 100 units box

- | | |
|------------------------|-----------------------|
| IP-490 Talla XL | IP-490 Size XL |
| IP-491 Talla L | IP-491 Size L |
| IP-492 Talla M | IP-492 Size M |
| IP-493 Talla S | IP-493 Size S |



Guantes de nitrilo (3.5gr) sin polvo, paquete de 100 unds

Powder free nitrile gloves (3.5gr) 100 units box

- | | |
|------------------------|-----------------------|
| IP-445 Talla XL | IP-445 Size XL |
| IP-450 Talla L | IP-450 Size L |
| IP-455 Talla M | IP-455 Size M |
| IP-460 Talla S | IP-460 Size S |
| IP-465 Talla XS | IP-465 Size XS |



Guantes de nitrilo extrafuertes (6gr) sin polvo, paquete 100 unds.

Extra strong nitrile gloves (6gr) powder free 100 units box

- | | |
|------------------------|-----------------------|
| IP-486 Talla XL | IP-486 Size XL |
| IP-487 Talla L | IP-487 Size L |
| IP-488 Talla M | IP-488 Size M |
| IP-489 Talla S | IP-489 Size S |



Guantes de nitrilo profesional (4.6gr) sin polvo, paquete 100 unds

Professional nitrile gloves (4.6gr) powder free, 100 units box

- | | |
|------------------------|-----------------------|
| IP-470 Talla XL | IP-470 Size XL |
| IP-475 Talla L | IP-475 Size L |
| IP-480 Talla M | IP-480 Size M |
| IP-485 Talla S | IP-485 Size S |



Guantes de nitrilo largos (8,8gr) sin polvo, paquete 100 unds

Long nitrile gloves (8,8gr) powder free, 100 units box

- | | |
|------------------------|-----------------------|
| IP-495 Talla XL | IP-495 Size XL |
| IP-496 Talla L | IP-496 Size L |
| IP-497 Talla M | IP-497 Size M |
| IP-498 Talla S | IP-498 Size S |



Guantes de nitrilo ULTRAGRIP naranja (8,5gr), paquete 50 unds

Orange ULTRAGRIP nitrile gloves (8,5) 50 units box

- | | |
|-------------------------|------------------------|
| IP-530 Talla L | IP-530 Size L |
| IP-531 Talla XL | IP-531 Size XL |
| IP-532 Talla XXL | IP-532 Size XXL |

Guantes PVC triple capa con manguito termosellado
Triple layer PVC gloves with heat-sealed cuff



IP-225 Talla 10 (XL)
IP-226 Talla 9 (L)
IP-227 Talla 8 (M)

IP-225 Size 10 (XL)
IP-226 Size 9 (L)
IP-227 Size 8 (M)



IP-210 Guantes con goma elástica de 55 cm, bolsa de 100 unidades

IP-210 55 cm gloves with elastic band, 100 units bag

Guantes sensitivos naranja de 90 cm
90 cm orange sensitive gloves

IP-200 Bolsa 100 uni.
IP-205 Caja 100 uni.

IP-200 100 units bag
IP-205 100 units box



IP-180 Guantes sensitivos de 90 cm, paquete de 100 unidades

IP-180 Sensitive gloves (90 cm) 100 units box

IP-175 Guantes supersensitivos de 90 cm, paquete de 100 unidades

IP-175 Supersensitive gloves (90 cm) 100 units box





IP-170 Guantes supersensitivos elásticos de 85 cm, paquete de 50 unidades

IP-170 Elastic supersensitive gloves, 85 cm, 50 units bagox



IP-165 Guantes sensitivos de 90 cm GLOVET, paquete de 100 unidades

IP-165 GLOVET sensitive gloves (90cm), 100 units box



IP-195 Guantes sensitivos de 90 cm con lazo para el cuello, paquete de 100 unidades

IP-195 Sensitive gloves (90 cm) with neck lace, 100 units box



IP-190 Guantes de protección de hombro y axila NECK, paquete de 50 unidades

IP-190 NECK gloves for shoulder and armpit protection, 50 units box



Guantes supersensitivos de protección de hombro y axila

IP-192 Paq. 100 unds

Super sensitive gloves for shoulder and armpit protection

IP-192 100 units box



IP-215 Guantes obstétricos porcino, 90 cm, bolsa de 5 unidades

IP-215 Pig obstetric gloves, 90 cm, 5 units bag





Mono impermeable para lavado y limpieza

Washing and cleaning overall

- IP-810** L
- IP-815** XL
- IP-820** XXL
- IP-825** XXXL



Conjunto impermeable pantalón y chaqueta

Waterproof jacket and trouser set

- IP-798** S
- IP-799** M
- IP-800** L
- IP-801** XL
- IP-802** XXL
- IP-803** XXXL

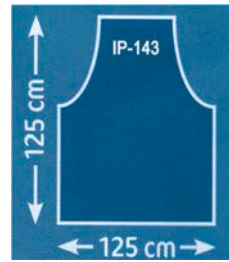
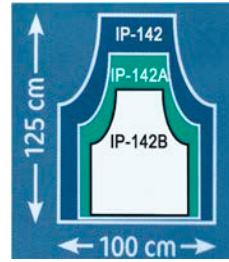
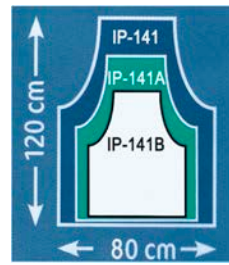

Delantal de ordeño y limpieza

Milking and washing apron

- | | |
|-------------------------------|-------------------------------|
| 80 x 120 cm | 100 x 125 cm |
| IP-141 (Azul-Blue) | IP-142 (Azul-Blue) |
| IP-141A (Verde-Green) | IP-142A (Verde-Green) |
| IP-141B (Blanco-White) | IP-142B (Blanco-White) |
| 125 x 125 cm | |
| IP-143 (Azul-Blue) | |



IP-600 hasta **IP-650** Botas superligeras -30 °C, tallas nº 39 hasta nº 49
IP-660 Calcetín para botas superligeras (par)

*IP-600 to IP-650 Light boots -30°, size nº 39 to 49
 IP-660 Sock for light boots (pair)*



IP-700 hasta **IP-740** Botas de seguridad superligeras S4 -30 °C, tallas nº 39 hasta nº 47
IP-750 Calcetín para botas de seguridad superligeras (par)

*IP-700 to IP-740 Super light safety S4 boots -30°C, size nº 39 to 47
 IP-750 Socks for safety super light boots (pair)*

Delantales / Botas Aprons / Boots



IP-900 hasta IP-912 Botas BEKINA AGRILITE 04 -20 °C, tallas nº 36 hasta nº 48

IP-915 hasta IP-927 Botas BEKINA AGRILITE S4 protección puntera -20 °C, tallas nº 36 hasta nº 48

IP-930 hasta IP-942 Botas BEKINA AGRILITE S5 protección completa -20 °C, tallas nº 36 hasta nº 48

IP-900 to IP-912 BEKINA AGRILITE 04 boots -20 °C, sizes nº 36 to nº 48

IP-915 to IP-927 BEKINA AGRILITE S4 boots -20 °C, protective toe cap, sizes nº 36 to nº 48

IP-930 to IP-942 BEKINA AGRILITE S5 boots -20 °C, protective toe and sole, sizes 36 to 48

IP-945 hasta IP-957 Botas BEKINA STEPLITE X 04 -30 °C, tallas nº 36 hasta nº 48

IP-960 hasta IP-972 Botas BEKINA STEPLITE X S4 protección puntera -30 °C, tallas nº 36 hasta nº 48

IP-975 hasta IP-987 Botas BEKINA STEPLITE X S5 protección completa -30 °C, tallas nº 36 hasta nº 48

IP-945 to IP-957 BEKINA STEPLITE X 04 boots -30 °C, sizes nº 36 to nº 48

IP-960 to IP-972 BEKINA STEPLITE X S4 boots -30 °C, protective toe cap, sizes nº 36 to nº 48

IP-975 to IP-987 BEKINA STEPLITE X S5 boots -30 °C, protective toe and sole, sizes nº 36 to nº 48



Para industria alimentaria

IP-990 hasta IP-990L Botas BEKINA STEPLITE FOOD S4 protección puntera -20 °C, tallas nº 36 hasta nº 48

IP-990 to IP-990L BEKINA STEPLITE FOOD S4 boots -20 °C, protective toe cap, sizes nº 36 to nº 48



IP-991A hasta IP-991M Plantillas BEKINA standard, tallas nº 36 hasta nº 48

IP-991A to IP-991M BEKINA standard insole, sizes nº 36 to nº 48



IP-992A hasta IP-992M Plantillas BEKINA ergonómica y antichoque, tallas nº 36 hasta nº 48

IP-992A to IP-992M BEKINA ergonomic and impact protection insole, sizes nº 36 to nº 48



IP-994 hasta IP-994K Botas DUNLOP PUROFORT PROFESSIONAL 04 -20 °C, tallas nº 37 hasta nº 48
IP-994 to IP-994K DUNLOP PUROFORT PROFESSIONAL 04 boots -20 °C, sizes nº 37 to nº 48

IP-995 hasta IP-995K Botas DUNLOP PUROFORT PROFESSIONAL S5 protección total, tallas nº 37 hasta nº 48
IP-995 to IP-995K DUNLOP PUROFORT PROFESSIONAL S5 boots, protective toe and sole, sizes nº 37 to nº 48

IP-996 hasta IP-996M Botas DUNLOP PUROFORT PLUS 04 -20 °C, tallas nº 36 hasta nº 50
IP-996 to IP-996M DUNLOP PUROFORT PLUS 04 boots -20 °C, sizes nº 36 to nº 50

IP-997 hasta IP-997M Botas DUNLOP PUROFORT PLUS S5 protección total -20 °C, tallas nº 36 hasta nº 50
IP-997 to IP-997M DUNLOP PUROFORT PLUS S5 boots -20 °C, protective toe and sole, sizes nº 36 to nº 50



IP-998 hasta IP-998H Botas DUNLOP PUROFORT THERMO S5 -50 °C, tallas nº 37 hasta nº 48

IP-998 to IP-998H DUNLOP PUROFORT THERMO S5 boots -50 °C, sizes nº 37 to nº 48

IP-999A hasta IP-999M Botas DUNLOP PUROFORT FOODPRO MULTIGRIP S4, tallas nº 37 hasta nº 50

IP-999A to IP-999M DUNLOP PUROFORT FOODPRO MULTIGRIP S4 boots, sizes nº 37 to nº 50



IB-755 Descalzador de botas

IB-755 Boot remover

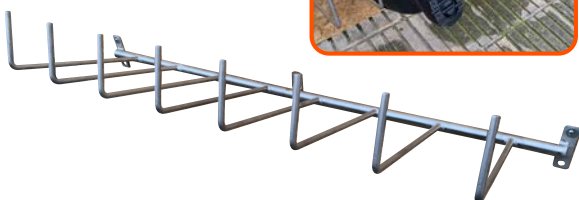

IP-885 Colgador de acero inox, para 3 pares de botas
IP-887 Colgador de acero inox, para 5 pares de botas

IP-885 Boot holder for 3 pairs, stainless steel
IP-887 Boot holder for 5 pairs, stainless steel

IP-890 Colgador para botas acero inox, para 4 pares, modelo inclinado

IP-890 Boot holder stainless steel for 4 pairs of boots, inclined model

Instrumental quirúrgico Surgical instruments



Hojas de bisturí
Scalpel blades

IQ-098 Nº 12 **IQ-099D** Nº 21
IQ-099 Nº 10 **IQ-100** Nº 22
IQ-099A Nº 11 **IQ-105** Nº 22A
IQ-099B Nº 15 **IQ-110** Nº 23
IQ-099C Nº 20 **IQ-110A** Nº 24

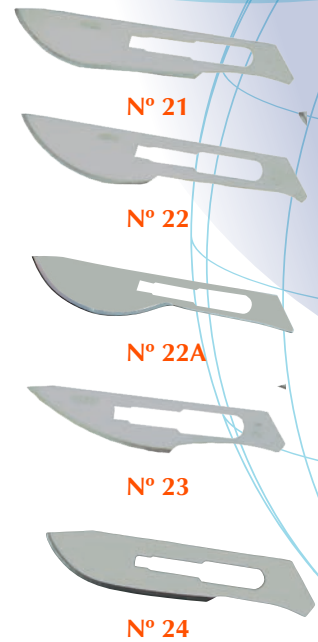

IQ-114 Mango de bisturí plegable

IQ-114 Foldable scalpel handle



IQ-113 Mango de bisturí nº 3

IQ-113 Scalpel handle, Nº 3



IQ-112 Mango de bisturí nº 4

IQ-112 Scalpel handle, Nº 4



DS-410 Gel solución hidroalcohólica SERBONET, 5 l

DS-410 SERBONET 5 l hydroalcoholic solution gel



DS-415 Dosificador de jabón y gel aut. por infrarrojos

DS-415 Automatic infrared soap and gel dispenser



IQ-115 Electrobisturí completo de 50 W

IQ-115 Complete electrocautery unit (50 W)



DG-220 Toallitas desinfectantes para instrumental, bote de 150 uds

DG-220 Disinfectant wipes for veterinary instruments, 150 units/dispenser



DS-402 Spray desinfectante higienizante de superficies, 400 ml

DS-402 Surface sanitizing disinfectant spray, 400 ml



IQ-116 Bisturí electroquirúrgico, 100 W

IQ-116 Electrocautery scalpel (100 W)



IQ-125 Tijera recta de 14 cm aguda/aguda
IQ-125A Tijera recta de 16 cm aguda/aguda

IQ-125 14 cm straight scissors pointed/pointed
IQ-125A 16 cm straight scissors pointed/pointed



IQ-120 Tijera curva de 14 cm aguda/aguda
IQ-120A Tijera curva de 16 cm aguda/aguda

IQ-120 14 cm curved scissors pointed/pointed
IQ-120A 16 cm curved scissors pointed/pointed



IQ-135 Tijera recta de 14 cm aguda/roma
IQ-135A Tijera recta de 16 cm aguda/roma

IQ-135 14 cm straight scissors pointed/blunt
IQ-135A 16 cm straight scissors pointed/blunt



IQ-130 Tijera curva de 14 cm aguda/roma
IQ-130A Tijera curva de 16 cm aguda/roma

IQ-130 14 cm curved scissors pointed/blunt
IQ-130A 16 cm curved scissors pointed/blunt



IQ-145 Tijera recta de 14 cm roma/roma
IQ-145A Tijera recta de 16 cm roma/roma

IQ-145 14 cm straight scissors blunt/blunt
IQ-145A 16 cm straight scissors blunt/blunt

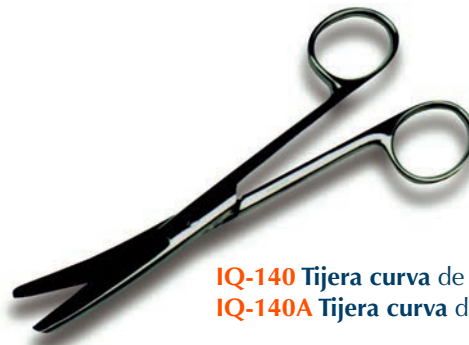

IQ-140 Tijera curva de 14 cm roma/roma
IQ-140A Tijera curva de 16 cm roma/roma

IQ-140 14 cm curved scissors blunt/blunt
IQ-140A 16 cm curved scissors blunt/blunt



IQ-150 Tijera recta de 20 cm aguda/roma

IQ-150 20 cm straight scissors pointed/blunt



IQ-150A Tijera curva de 20 cm aguda/roma

IQ-150A 20 cm curved scissors pointed/blunt



IQ-151 Tijera recta de 20 cm aguda/aguda

IQ-151 20 cm straight scissors pointed/pointed



IQ-151A Tijera curva de 20 cm aguda/aguda

IQ-151A 20 cm curved scissors pointed/pointed

Instrumental quirúrgico Surgical instruments



IQ-160 Tijera recta MAYO-STILLE de 17 cm

IQ-160 17 cm MAYO-STILLE scissors, straight



IQ-155 Tijera curva MAYO-STILLE de 17 cm

IQ-155 17 cm MAYO-STILLE scissors, curved



IQ-185 Tijera recta METZENBAUM de 17 cm

IQ-185 17 cm METZEMBAUM scissors, straight

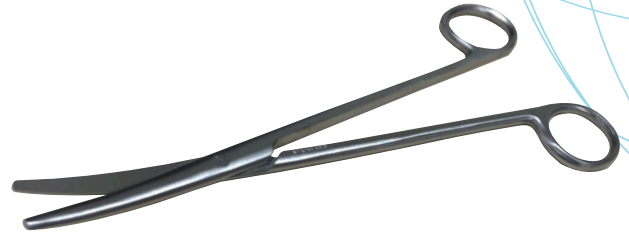

IQ-184 Tijera METZENBAUM de 17 cm curva

IQ-184 17 cm METZEMBAUM scissors, curved



IQ-165 Tijera LISTER para vendaje de 14 cm

IQ-165 14 cm LISTER bandage scissors



IQ-170 Tijera LISTER para vendaje de 18 cm

IQ-170 18 cm LISTER bandage scissors



IQ-186 Tijera JESCO de 18 cm

IQ-186 18 cm JESCO scissors



IQ-190 Tijera recta IRIS de 11 cm

IQ-191 Tijera curva IRIS de 11 cm

IQ-190 11 cm IRIS straight scissors

IQ-191 11 cm IRIS curved scissors



IQ-180 Tijera SPENCER para quitar puntos de 9 cm

IQ-175 Tijera LITTAUER para quitar puntos de 14 cm

IQ-180 9 cm SPENCER scissors for suture removal

IQ-175 14 cm LITTAUER scissors for suture removal



Pinza Kocher
Kocher forceps

IQ-200 16 cm con dientes, curva
IQ-220 18 cm con dientes, curva

IQ-200 16 cm with teeth, curved
IQ-220 18 cm with teeth, curved



Pinza Kocher
Kocher forceps

IQ-199 15 cm con dientes, recta
IQ-205 16 cm con dientes, recta
IQ-225 18 cm con dientes, recta

IQ-199 15 cm with teeth, straight
IQ-205 16 cm with teeth, straight
IQ-225 18 cm with teeth, straight



Pinza Kocher
Kocher forceps

IQ-210 16 cm sin dientes, curva
IQ-230 18 cm sin dientes, curva

IQ-210 16 cm without teeth, curved
IQ-230 18 cm without teeth, curved



Pinza Kocher
Kocher forceps

IQ-215 16 cm sin dientes, recta
IQ-235 18 cm sin dientes, recta

IQ-215 16 cm without teeth, straight
IQ-235 18 cm without teeth, straight



IQ-640 Bandeja acero inox para instrumental 27x20x4

IQ-640 Stainless steel tray for instruments 27x20x4

Instrumental quirúrgico

Surgical instruments



IQ-265 Pinza recta mosquito sin dientes

IQ-265 Mosquito forceps without teeth, straight



IQ-260 Pinza curva mosquito sin dientes

IQ-260 Mosquito forceps without teeth, curved



IQ-255 Pinza recta mosquito con dientes

IQ-255 Mosquito forceps with teeth, straight



IQ-250 Pinza curva mosquito con dientes

IQ-250 Mosquito forceps with teeth, curved



IQ-245 Pinza recta CRILE de 14 cm

IQ-240 Pinza curva CRILE de 14 cm

IQ-245 14 cm CRILE forceps, straight

IQ-240 14 cm CRILE forceps, curved



IQ-285 Pinza PEAN de 14 cm

IQ-285 14 cm PEAN forceps



IQ-275 Pinza recta intestinal de 23 cm

IQ-275 23 cm intestinal forceps, straight



IQ-270 Pinza curva intestinal de 23 cm

IQ-270 23 cm intestinal forceps, curved



IQ-280 Pinza ALLIS de 15 cm

IQ-280 15 cm ALLIS forceps



Pinza tipo cocodrilo HARTMANN

HARTMANN crocodile forceps

IQ-345 13 cm

IQ-346 8 cm

IQ-344 13 cm, extrafina

IQ-345 13 cm

IQ-346 8 cm

IQ-344 13 cm (Thinner model)



IQ-539A Plexímetro para veterinaria

IQ-539A Veterinary pleximeter



IQ-650 Estuche de instrumental veterinario para 10 piezas (estuche vacío)

IQ-650 Empty case for 10 veterinary instruments

Los estuches pueden ser personalizados con el instrumental veterinario que deseen

Cases can be personalized with the veterinary instruments you require



IQ-325 Pinza campo cangrejo, SCHAEDEL de 9 cm

IQ-325 SCHAEDEL towel clamp, 9 cm

IQ-330 Pinza BACKHAUS de 9 cm

IQ-330 9 cm BAKHAUS forceps



IQ-435 Sonda acanalada

IQ-435 Grooved director



IQ-539 Martillo percutor TRÖMMER

IQ-539 TRÖMMER striker hammer



IQ-538 Martillo percutor TAYLOR

IQ-538 TAYLOR striker hammer

IQ-655 Estuche de instrumental veterinario con 10

piezas, compuesto de:

- Pinza de disección de 13 cm, sin dientes
- Pinza Pean de 14 cm
- Mango de bisturí de nº 4
- Tijera de 14 cm, aguda/roma recta
- Pinza Adson sin dientes
- Pinza mosquito sin dientes recta
- Tijera Spencer para quitar puntos de 9 cm
- Hoja de bisturí nº 22
- Portaguas de Mathieu de 18 cm
- Pinza Felchenfelt para espinas

IQ-655 Veterinary instruments case. Composed of ten items:

- 13 cm dissection forceps
- 14 cm Pean forceps
- Scalpel handle, n.4
- 14 cm scissors, pointed/blunt, straight
- Adson dissection forceps
- Mosquito forceps, straight
- 9 cm Spencer suture scissors
- Scalpel blade, n.22
- Mathieu needle-holder, 18 cm
- Fenchenfelt splinter forceps

Instrumental quirúrgico Surgical instruments



Pinza para panza BLENDING
BLENDING paunch forceps

IQ-365 20 cm con gancho
IQ-370 20 cm sin gancho

IQ-365 20 cm, with hook
IQ-370 20 cm, without hook



Pinza para útero cabeza goma
Uterus forceps with rubber top

IQ-340 28 cm
IQ-341 16 cm

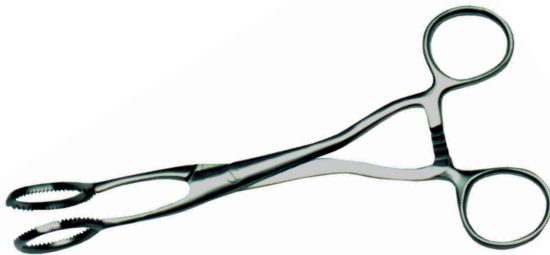

IQ-355 Pinza tira lenguas COLLING de 17 cm

IQ-355 COLLING tongue forceps, 17 cm



IQ-315 Pinza ADSON sin dientes

IQ-315 ADSON dissection forceps



Pinza para oído, según LUCAE
LUCAE ear forceps

IQ-337 16 cm
IQ-338 14 cm



Pinza de disección sin dientes
Dissection forceps

IQ-286 13 cm
IQ-295 16 cm
IQ-305 20 cm



IQ-310 Pinza ADSON con dientes

IQ-310 ADSON dissection forceps with teeth



Pinza para oído acodada
Elbow ear forceps

IQ-335 16 cm
IQ-336 14 cm



Pinza de disección
Dissection forceps

IQ-290 16 cm con dientes de 1x2
IQ-291 16 cm con dientes de 2x3
IQ-292 18 cm con dientes de 2x3

IQ-290 16 cm with teeth (1 x 2)
IQ-291 16 cm with teeth (2 x 3)
IQ-292 18 cm with teeth (2 x 3)



Pinza de disección con dientes
Dissection forceps with teeth

IQ-287 13 cm
IQ-300 20 cm



IQ-320 Pinza para espinas
FELCHENFELT

IQ-320 FELCHENFELT splinter forceps



IO-170 **Espéculo vaginal** desechable
IO-175 **Espéculo vaginal** desechable, mini

IO-170 Disposable *vaginal speculum*
IO-175 Disposable *vaginal speculum, mini*



Espéculo vaginal POLANSKY
POLANSKY vaginal speculum

IQ-537 37 cm
IQ-537A 27 cm



Espéculo vaginal con mango de iluminación
Vaginal speculum with illumination handle

IQ-536C 120 x 20 mm
IQ-536 250 x 30 mm
IQ-536A 350 x 40 mm
IQ-536B 420 x 50 mm



IQ-530 **Espéculo vaginal y nasal** KILLIAN

IQ-530 KILLIAN *vaginal and nasal speculum*



IQ-535 **Espéculo vaginal y nasal** HARTMANN

IQ-535 HARTMANN *vaginal and nasal speculum*

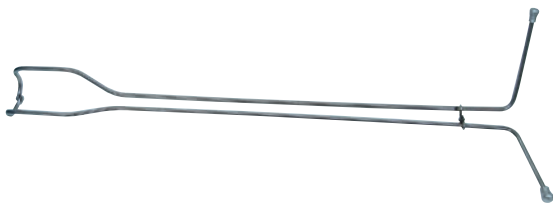

IO-114 **Forceps** obstétricos modelo danés de, 52 cm

IO-114 *Obstetric forceps* danish model, 52 cm



IO-115 **Forceps** obstétricos, según WITT, de 52 cm

IO-115 WITT *obstetric forceps*, 52 cm



IO-164 **Hisopo** veterinario LARYNGEAL extralargo 27 cm, paq. 100

IO-164 LARYNGEAL extra large veterinary *swab* 27 cm. Bag with 100 pcs



IO-160 **Hisopo** estéril de 15 cm para recogida de muestras (con medio de cultivo)

IO-161 **Hisopo** estéril de 15 cm para recogida de muestras (sin medio de cultivo)

IO-160 Sterile *swab* (15 cm) to obtain samples (With transport medium)

IO-161 Sterile *swab* (15 cm) to obtain samples (Without transport medium)

Instrumental quirúrgico / Obstetricia

Surgical instruments / Obstetrics



IO-145 Tenaza HAUPTNER para ágrafes de sutura

IO-140 Ágrafes HAUPTNER grandes niquelados, paquete de 100 unidades

IO-145 HAUPTNER suture wire ring **applicator**

IO-140 HAUPTNER large **wire rings**, nickel-plated, 100 units package

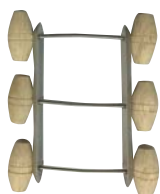

IO-120 Cierre vaginal HAUPTNER, completo

IO-120 HAUPTNER complete **vaginal closing**

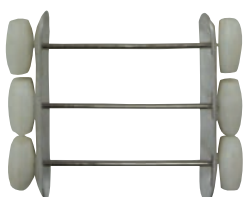

Cierre vaginal
Vaginal closing

IO-117 60 mm

IO-118 80 mm

IO-119 100 mm



Imperdible vaginal
Vaginal needles

IO-121 Grande

IO-121 Large

IO-121A Mediano

IO-121A Medium

IO-121B Pequeño

IO-121B Small



IO-116A Guía para lazo
corredizo según sand 17,5 cm

IO-116A Sand rope carrier, 17.5 cm



IO-129 **Cuerda** larga para partos de
1,8 m x 12 mm, un nudo

IO-129 Long perlon **rope**, 1.8 m x 12 mm,
one loop

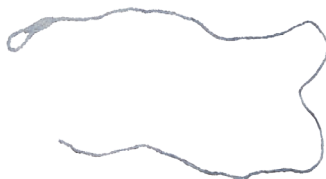

IO-126 **Cuerda** larga para partos de
2 m x 7 mm, un nudo

IO-126 Long perlon **rope**, 2 m x 7 mm,
one loop



Cuerda larga para partos, dos nudos
Long perlon **rope**, double loop

IO-127 1,8 m x 12 mm

IO-128 1,9 m x 9 mm

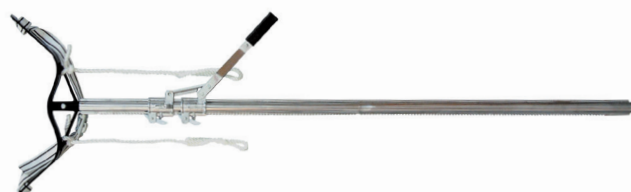

IO-129 **Ayuda partos** para ganado vacuno

IO-129 Cattle **labour's help**



IO-124 **Cuerda** corta para partos

IO-124 Short perlon **rope**



IN-123 Correa para prolapsos de vacas

IN-123 Prolapse rope for dairy cows

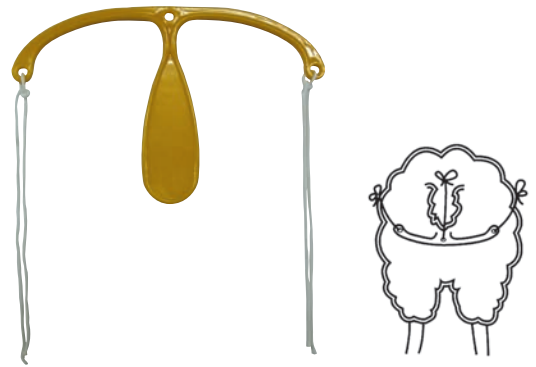

IO-122 Prolapso para ovino con cuerdas de sujeción

IO-122 Sheep prolapse with fastening ropes

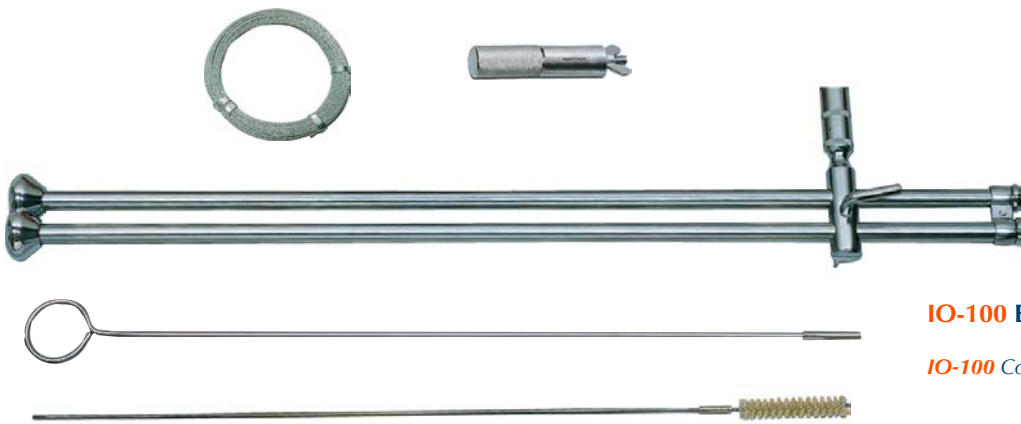

IO-100 Embriotomo completo HAUPTNER

IO-100 Complete HAUPTNER embriotome



IO-110 Gancho obstétrico romo

IO-105 Gancho obstétrico HARMS agudo

IO-110 Obstetric blunt hook

IO-105 HARMS obstetric pointed hook



IO-112 Escalpel LINDE de 11 cm

IO-112 LINDE scalpel, 11 cm



IO-123 Arnés para prolapso ovino

IO-123 Harness for sheep prolapse

IO-113 Gancho KREY-SCHOTTLER

IO-113 KREY-SCHOTTLER hook





IQ-395 Separador WEITLANER de 13 cm
IQ-400 Separador WEITLANER de 16 cm

IQ-395 13 cm WEITLANER retractor
IQ-400 16 cm WEITLANER retractor



IQ-430 Juego de separadores ROUX

IQ-430 ROUX retractor set



Separadores FARABEUF
FARABEUF retractor

IQ-405 Grandes, juego de 2
IQ-406 Pequeños, juego de 2

IQ-405 Large set (pair)
IQ-406 Small set (pair)



Separador VOLKMANN
VOLKMANN retractor

IQ-410 2 garfios agudos
IQ-410A 2 garfios romos

IQ-410 2 hooks pointed
IQ-410A 2 hooks blunt



Separadores VOLKMANN
VOLKMANN retractor

IQ-415 3 garfios agudos
IQ-415A 3 garfios romos
IQ-420 4 garfios agudos
IQ-420A 4 garfios romos

IQ-415 3 hooks pointed
IQ-415A 3 hooks blunt
IQ-420 4 hooks pointed
IQ-420A 4 hooks blunt



IQ-705 Martillo para autopsias de 22,5 cm, mango de madera

IQ-705 Autopsy **hammer**, 22.5 cm, wooden handle



IQ-700 Martillo para autopsias LUCAE de 25 cm, mango metálico

IQ-700 Autopsy **LUCAE hammer**, 25 cm metallic handle



IQ-718 Cuchillo para autopsias de 27 cm
IQ-718 27cm autopsy **knife**



IQ-710 Serrucho para autopsias de 23 cm (hoja de 14 cm)

IQ-710 Autopsy **handsaw**, 23 cm (14 cm blade)



IQ-715 Sierra para autopsias de 39 cm (hoja de 25 cm)

IQ-715 Autopsy **saw**, 39 cm (25 cm blade)



IQ-725 Cureta cortante doble VOLKMANN de 15 x 10 mm, de 20 cm

IQ-725 Double **cutting** VOLKMANN curette, 15 x 10 mm, 20 cm



IQ-720 Cureta cortante VOLKMANN de 15 x 10 mm, de 17 cm

IQ-720 VOLKMANN cutting curette, 15 x 10 mm, 17 cm



IQ-690 Kit completo para autopsias

IQ-690 Complete autopsy kit

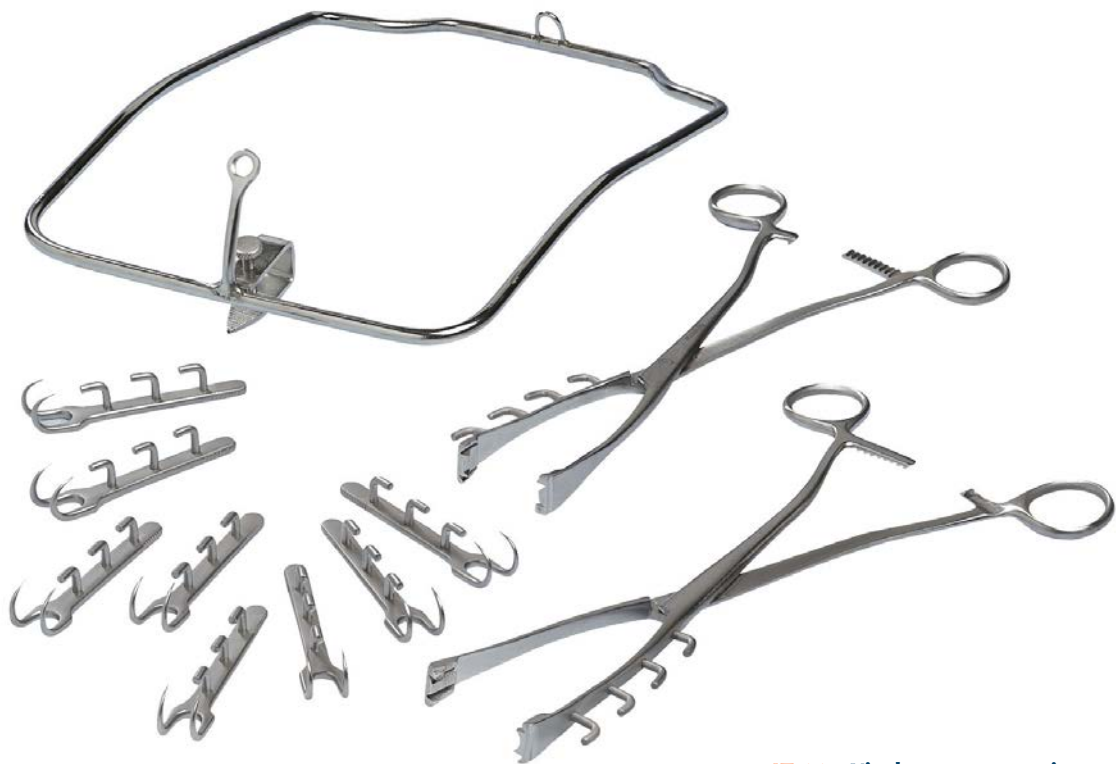

IT-117 Kit de rumenotomia completo

IT-117 Completet rumetnotomy kit

Instrumental quirúrgico

Surgical instruments

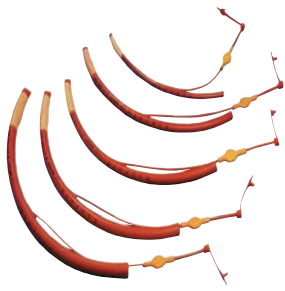

Sondas endotraqueales con balón
Endotracheal probes with olive-tip

PA-450 4 mm **PA-450C** 7 mm
PA-450A 5 mm **PA-450D** 8 mm
PA-450B 6 mm **PA-450E** 9 mm



PA-455 Juego de conectores para sondas endotraqueales

PA-455 Set of connectors for endotracheal probes

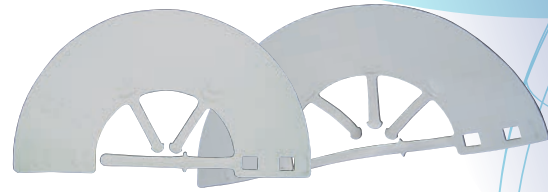

Cabezal protector / Protecting head

PA-100 7,5 cm **PA-120** 20 cm
PA-105 10 cm **PA-125** 25 cm
PA-110 12,5 cm **PA-130** 30 cm
PA-115 15 cm



PA-425 Mesa de quirófano eléctrica regulable, 1.300 x 600 x 450 - 1.000 cm

PA-425 Adjustable electric operating table, 1,300 x 600 x 450 x 1,000 cm

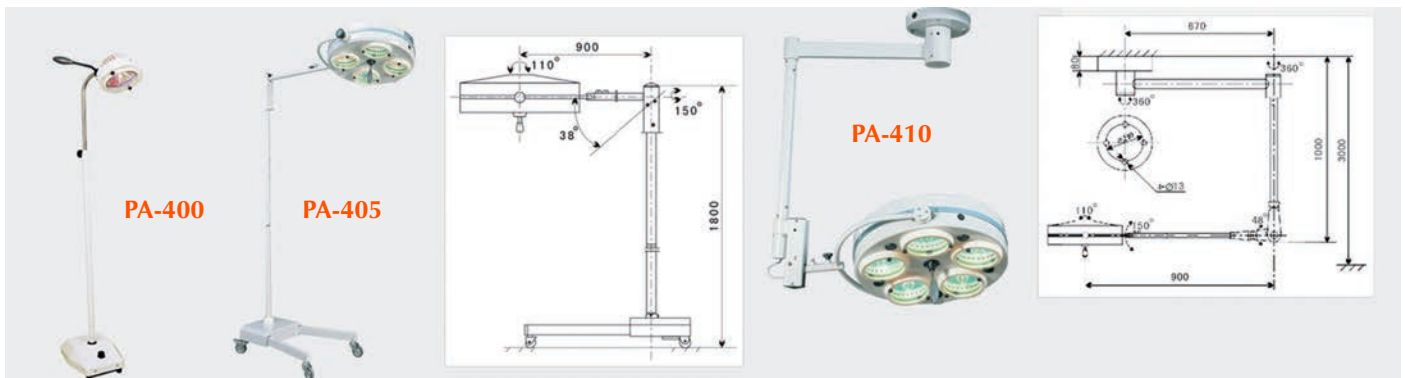

PA-400 Lámpara quirófano de pie, de un foco con luz fría
PA-405 Lámpara quirófano de pie, de cuatro focos con luz fría
PA-410 Lámpara quirófano de techo, de cinco focos con luz fría

PA-400 Stand lamp for operation room, 1 cold light bulb
PA-405 Stand lamp for operation room, 4 cold light bulbs
PA-410 Ceiling lamp for operation room, 5 cold light bulbs

Modelo <i>Model</i>	Intensidad de la luz <i>Intensity of light</i>	Temperatura de color <i>Color temperature</i>	Ajuste de gama de iluminación del campo <i>Adjustment range of illuminated field</i>	Rango de ajuste vertical <i>Range of vertical adjustment</i>	Díámetro de foco <i>Diameter of lamphead</i>	Red de suministro <i>Mains supply</i>	Consumo de energía <i>Power consumption</i>
	(en distancia de 1 m) <i>(at 1 m distance)</i>	(K)	(\varnothing mm)	(mm)	(\varnothing mm)	(V/Hz)	(W)
PA-400	20	3,000+-500	100-150	600	/	220/50	50
PA-405	40	4,000+-500	100-200	400	500	220/50	100
PA-410	50	4,000+-500	100-200	400	500	220/50	125



IQ-500 Otoscopio GOWLLANDS

IQ-500 GOWLLANDS otoscope



IQ-505 Otoscopio-oftalmoscopio GOWLLANDS

IQ-505 GOWLLANDS otoscope-ophthalmoscope



IQ-508 Equipo completo de diagnóstico GOWLLANDS Oto-oftal-larin

IQ-508 GOWLLANDS complete set: otoscope, ophthalmoscope and laryngoscope

IQ-525 Vídeo-endoscopio-otoscopio completo con tres camaras de vídeo

IQ-525 Video otoscope-endoscope complete with 3 cams



IQ-555
Fonendoscopio
Phonendoscope



IQ-550 **IQ-540**
IQ-545

IQ-540 1 membrane
IQ-545 Double membrane
IQ-550 NISSEI RAPPAPORT
IQ-555 HAUPTNER

IQ-540 Una membrana
IQ-545 Doble membrana
IQ-550 NISSEI RAPPAPORT
IQ-555 HAUPTNER



IQ-480 Fórceps de extracción dental rectos
IQ-485 Fórceps de extracción dental universales

IQ-480 Tooth forceps, straight
IQ-485 Tooth forceps, universal



Cortaorejas para perros
Ear notcher for dogs

IQ-610A 9,5 cm, recto
IQ-610 14 cm, recto
IQ-615 14 cm, curvo

IQ-610A 9.5 cm, straight
IQ-610 14 cm, straight
IQ-615 14 cm, curved

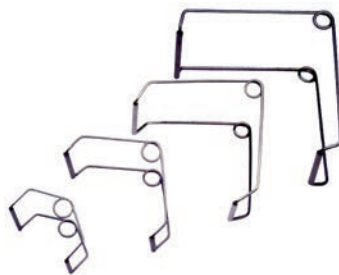

PA-270 Juego de abre bocas
SMITH-BAXTER

PA-270 SMITH-BAXTER mouth gag kit



Abrebocas
Mouth gag

PA-250 6 cm, para gatos *PA-250 6 cm, for cats*
PA-260 11 cm, para perros *PA-260 11 cm, for dogs*
PA-265 16 cm, para perros *PA-265 16 cm, for dogs*

Instrumental quirúrgico Surgical instruments

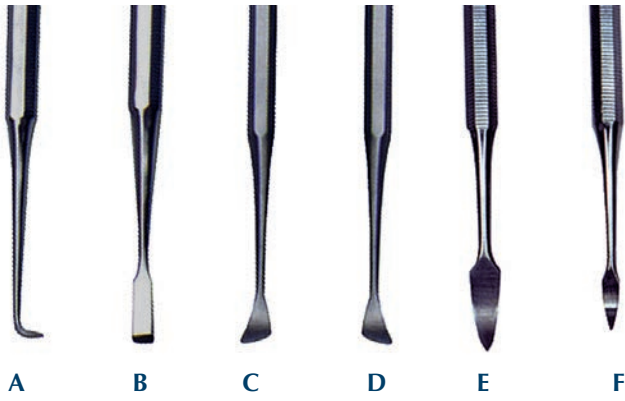

IQ-475 Raspador dental para perros (varias medidas)
IQ-475 Dental scaler for dogs (several sizes)



PA-206 Tijeras cortaúñas de 18,5 cm, para perros
PA-206 18.5 cm nail clipper for dogs



PA-207 Lima para uñas de perros a pilas
PA-207 Battery powered nail trimmer for dogs



PA-205 Tijeras cortaúñas para gatos
PA-205 Nail clipper for cats



PA-210 Cortaúñas para pequeños animales tipo guillotina
PA-210 Nail cutters for small animals with guillotine action



IQ-495 Pulsioxímetro portátil veterinario
IQ-495 Veterinary portable pulse oximeter

IA-712 Alcohol 96° botella de 1l.
IA-713 Alcohol 70° botella de 1l.

IA-712 Alcohol 96° bottle 1l.
IA-713 Alcohol 70° bottle 1l.



DS-845 Spray INTRA DERMA de 100 ml.
DS-845 INTRADERMA spray of 100 ml



IS-588 Rasuradora desechable no estéril de 2 hojas, paq. de 100 unds
IS-588 Non-sterile 2-blade disposable razor, pack of 100 units



IA-712A POVIDONA YODADA de 500 ml
IA-712 POVIDONE IODINE of 500 ml



IS-590 Grapadora de sutura precargada con 35 grapas (estéril)

IS-595 Pinza extractora de grapas (estéril)

IS-590 Suture stapler with 35 staples (sterile)

IS-595 Staple extracting forceps (sterile)



PA-220 Bastoncillos de algodón para orejas, tamaño L/XL, paq. 30 uds.

PA-222 Bastoncillos de algodón para orejas, tamaño S/M, paq. 30 uds.

PA-220 Cotton swabs for ears, size L/XL, pack of 30 units

PA-222 Cotton swabs for ears, size S/M, pack of 30 units



IT-220 Botella biberón de 500 ml, para pequeños animales

IT-220 Feeding bottle for small animals, 500 ml



PA-650 Comedero-bebedero maxi para perro, de 265 mm ø

PA-650 Feeder-drinker maxi for dogs, 265 mm Ø



PA-660 Comedero-bebedero para gatos, de 160 mm ø

PA-660 Feeder-drinker for cats, 160 mm Ø



PA-150 CACACAN, paq. de 25 uds.

PA-155 Expositor con 25 sobres

PA-150 CACACAN, box of 25 units

PA-155 Display with 25 cards



PA-225 Pinza para extracción de garrapatas

PA-225 Tick remover



IT-190 Tetina para pequeños animales

IT-190 Teat for small animals



Venda elástica adhesiva
Elastic adhesive bandage

PA-330 10 cm x 4,5 m

PA-330 10 cm x 4.5 m



PA-395 Vendaje para ubres de vacas de 6x5 m

PA-395 6x5 m Teat bandage for cow udders



Venda cohesiva
Cohesive bandages

PA-275 6 cm x 4 m

PA-280 8 cm x 4 m

PA-285 10 cm x 4 m



PA-390 Venda de alquitrán de 25 m

PA-390 25 m KROMBERG tar bandage



PA-365 Venda sintética poliéster blanca, 10 cm x 3,6 m

PA-365 White polyester synthetic bandage, 10 cm x 3.6 m



Venda de gasa
Gauze bandages

PA-385 10 cm x 10 m. G-7

PA-385A 10 cm x 10 m. LYS

PA-385B 10 cm x 10 m. CAMBRIC

Vendas cohesivas INSERTFIX

INSERTFIX cohesive bandages



PA-315 De 5 x 450 cm, paquete de 12 unidades

PA-315 5 x 450 cm, box of 12 units



PA-320 De 7,5 x 450 cm, paquete de 12 unidades

PA-320 7.5 x 450 cm, box of 12 units



PA-325 De 10 x 450 cm, paquete de 12 unidades

PA-325 10 x 450 cm, box of 12 units

Vendas cohesivas / Suturas

Cohesive bandages / Sutures



SUPRAMID, paq. de 36 sobres, con aguja curva
SUPRAMID, box of 36 envelopes, with curved needle

- IS-163E** N° 2
- IS-163F** N° 000
- IS-163G** N° 00
- IS-163H** N° 0
- IS-163I** N° 1

SUPRAMID, paq. de 36 sobres, con aguja recta
SUPRAMID, box of 36 envelopes, with straight needle

- IS-163B** N° 00 con aguja recta
- IS-163B** n. 00 with straight needle



Seda trenzada, paq. de 12 sobres
Braided silk, box of 12 envelopes

- IS-153** N° 00
- IS-153A** N° 0
- IS-154** N° 1
- IS-154A** N° 2
- IS-155** N° 3-4
- IS-155B** N° 5
- IS-155C** N° 6



Seda trenzada, paq. de 12 sobres, con aguja recta
Braided silk, box of 12 envelopes, with straight needle

- IS-160** N° 1
- IS-160B** N° 2
- IS-161** N° 0000
- IS-161A** N° 000
- IS-161B** N° 00
- IS-161C** N° 0

Seda trenzada, paq. de 12 sobres, con aguja curva
Braided silk, box of 12 envelopes, with curved needle

- IS-160A** N° 1
- IS-160C** N° 2
- IS-161D** N° 0000
- IS-161E** N° 000
- IS-161F** N° 00
- IS-161G** N° 0



Ac. poliglicólico (PGA), paq. de 12 sobres
Polyglycolic acid suture, box of 12 pcs

Sobre de 140 cm
140 cm envelope

- IS-115** N° 0
- IS-120** N° 1
- IS-125** N° 2

Sobre de 70 cm con aguja
70 cm envelope, with needle

- IS-130** N° 0
- IS-135** N° 1
- IS-140** N° 2

Carrete estéril catgut
Sterile cassette catgut

- 75 m
- IS-165 N° 00
- IS-170 N° 0
- 50 m
- IS-175 N° 1
- IS-180 N° 2
- IS-190 N° 3-4
- 25 m
- IS-192 N° 5
- IS-195 N° 6



PGA en carrete estéril
Sterile cassette PGA

- IS-196E N° 5
- IS-196F N° 6



Carrete estéril SUPRAMID
Sterile cassette SUPRAMID

- 50 m
- IS-245 N° 00
- IS-250 N° 0
- IS-255 N° 1
- IS-280 N° 3-4 40 mts (Blanco / White)
- IS-286 N° 6 - 25 mts (Blanco / White)
- 25 m
- IS-260 N° 2
- IS-283 N° 5
- IS-285 N° 6



Seda trenzada carrete estéril
Sterile braided silk cassette

- 100 m
- IS-200 N° 000
- IS-205 N° 00
- IS-211 N° 0
- IS-215 N° 1
- 50 m
- IS-220 N° 2
- IS-236 N° 5
- 25 m
- IS-230 N° 3-4
- 40 m
- IS-241 N° 6
- 30 m
- IS-242 N° 7



Seda trenzada
Braided silk

- 50 m
- IS-290 N° 00
- IS-295 N° 0
- IS-300 N° 1
- IS-305 N° 2
- IS-315 N° 3-4
- IS-320 N° 5
- IS-325 N° 6
- 10 m
- IS-330 N° 00
- IS-335 N° 0
- IS-340 N° 1
- IS-345 N° 2
- IS-352 N° 3-4
- IS-360 N° 5
- IS-364 N° 6

IS-367 Cinta para sutura vaginal de 5 m

IS-367 Vaginal suture tape, 5 m



IO-145 Tenaza HAUPTNER para ágrafas de sutura
IO-140 Ágrafas HAUPTNER grandes niqueladas, paq. de 100 uds

IO-145 HAUPTNER suture wire ring applicator
IO-140 HAUPTNER large wire rings, nickel-plated, 100 units Package



IS-590 Grapadora de sutura
precargada con 35 grapas (estéril)
IS-595 Pinza extractora de grapas (estéril)

IS-590 Suture stapler with 35 staples (sterile)
IS-595 Staple extracting forceps (sterile)

Agujas de sutura especiales para veterinaria

Suture needles for veterinary use

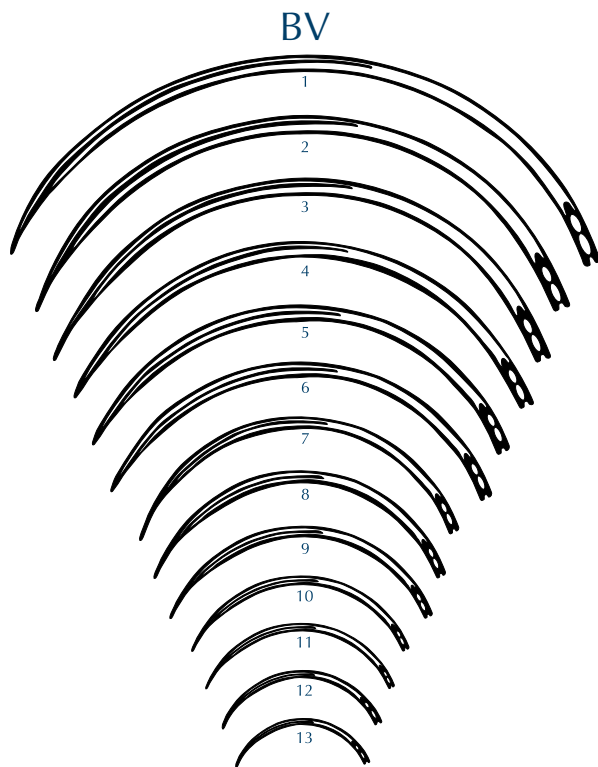

Agujas de sutura BV, paq. de 12 uds
"BV" suture needles, box of 12 units

- | | |
|-------------|--------------|
| IS-900 N° 1 | IS-918 N° 8 |
| IS-902 N° 2 | IS-920 N° 9 |
| IS-905 N° 3 | IS-922 N° 10 |
| IS-907 N° 4 | IS-925 N° 11 |
| IS-910 N° 5 | IS-927 N° 12 |
| IS-912 N° 6 | IS-930 N° 13 |
| IS-915 N° 7 | |

Agujas de sutura curvas perfil redondo
HAUPTNER, paq. de 12 uds
HAUPTNER curved and round suture needles,
box of 12 units

- | | |
|---------------|--------------|
| IS-717 N° 000 | IS-745 N° 6 |
| IS-718 N° 00 | IS-750 N° 7 |
| IS-719 N° 0 | IS-755 N° 8 |
| IS-720 N° 1 | IS-760 N° 9 |
| IS-725 N° 2 | IS-765 N° 10 |
| IS-730 N° 3 | IS-770 N° 11 |
| IS-735 N° 4 | IS-775 N° 12 |
| IS-740 N° 5 | |

Material para suturas

Suture materials

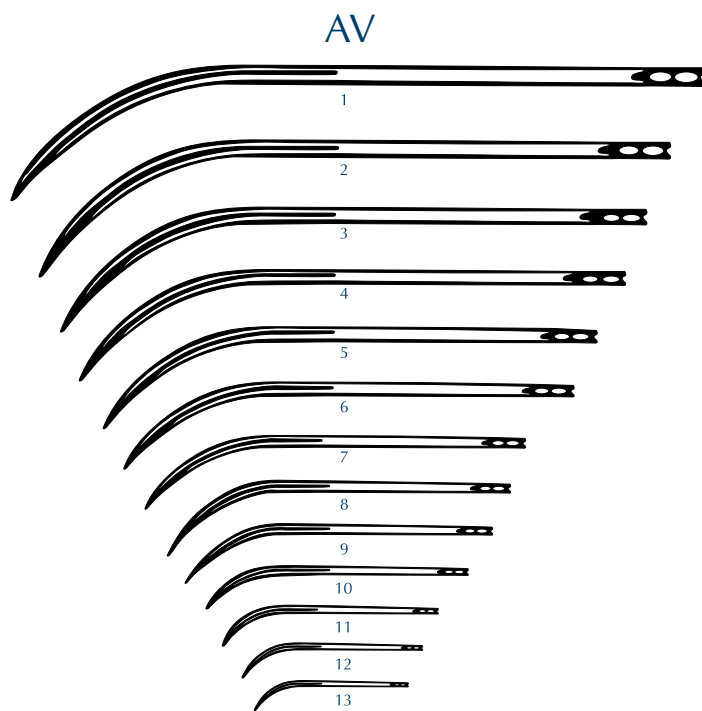

Agujas de sutura AV, paq. de 12 uds
"AV" suture needles, box of 12 units

- | | |
|-------------|--------------|
| IS-935 N° 1 | IS-951 N° 8 |
| IS-936 N° 2 | IS-955 N° 9 |
| IS-940 N° 3 | IS-956 N° 10 |
| IS-941 N° 4 | IS-960 N° 11 |
| IS-945 N° 5 | IS-961 N° 12 |
| IS-946 N° 6 | IS-965 N° 13 |
| IS-950 N° 7 | |

Tamaño Real
Real Size

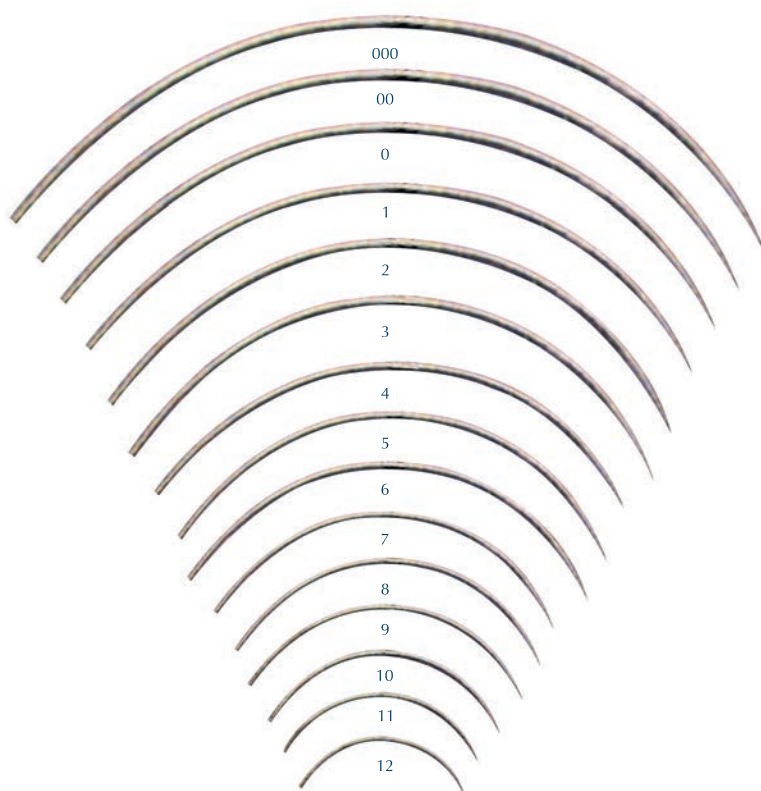

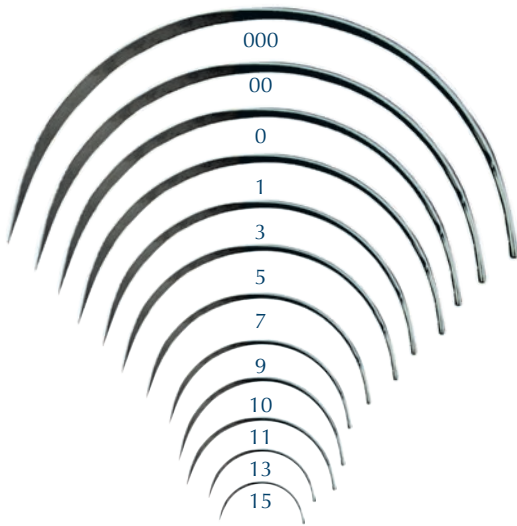

Agujas de sutura G 1/2, paq. de 12 uds
"G" suture needles, 12 units package

- | | |
|----------------------|---------------------|
| IS-414 N° 000 | IS-435 N° 7 |
| IS-415 N° 00 | IS-440 N° 9 |
| IS-416 N° 0 | IS-442 N° 10 |
| IS-420 N° 1 | IS-445 N° 11 |
| IS-425 N° 3 | IS-450 N° 13 |
| IS-430 N° 5 | IS-455 N° 15 |

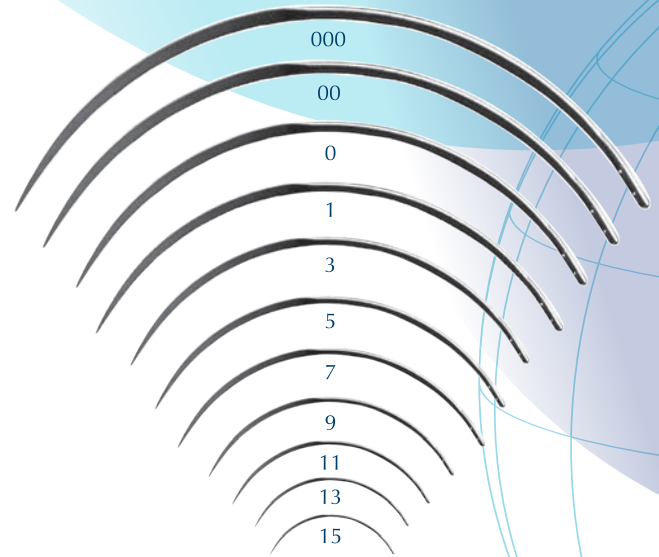

Agujas de sutura B 3/8, paq. de 12 uds
"B" 3/8 suture needles, 12 units package

- | | |
|----------------------|---------------------|
| IS-369 N° 000 | IS-390 N° 7 |
| IS-370 N° 00 | IS-395 N° 9 |
| IS-371 N° 0 | IS-400 N° 11 |
| IS-375 N° 1 | IS-405 N° 13 |
| IS-380 N° 3 | IS-410 N° 15 |
| IS-385 N° 5 | |

Tamaño real *Real Size*

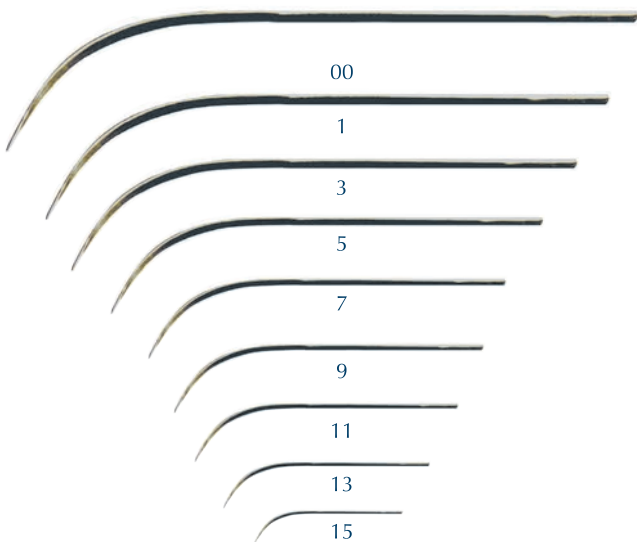

Agujas de sutura A RC, paq. de 12 uds
"A RC" suture needles, 12 units package

- | | |
|---------------------|---------------------|
| IS-460 N° 00 | IS-485 N° 9 |
| IS-465 N° 1 | IS-490 N° 11 |
| IS-470 N° 3 | IS-493 N° 13 |
| IS-475 N° 5 | IS-495 N° 15 |
| IS-480 N° 7 | |

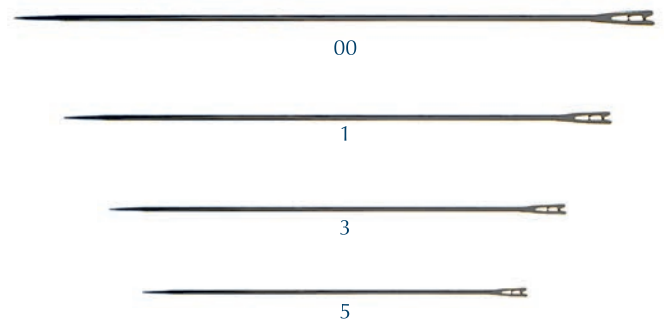

Agujas de sutura KEITH, paq. de 12 uds
KEITH suture needles, 12 units package

- | |
|---------------------|
| IS-500 N° 00 |
| IS-505 N° 1 |
| IS-510 N° 3 |
| IS-515 N° 5 |

Agujas de sutura especiales para veterinaria

Material para suturas Suture materials

Suture needles for veterinary use

Tamaño real
Real Size

Agujas de sutura PM/A, paq. de 12 uds
"PM/A" suture needles, box of 12 units

- IS-800 N° 1
- IS-805 N° 2
- IS-810 N° 3
- IS-815 N° 4
- IS-820 N° 5
- IS-825 N° 6

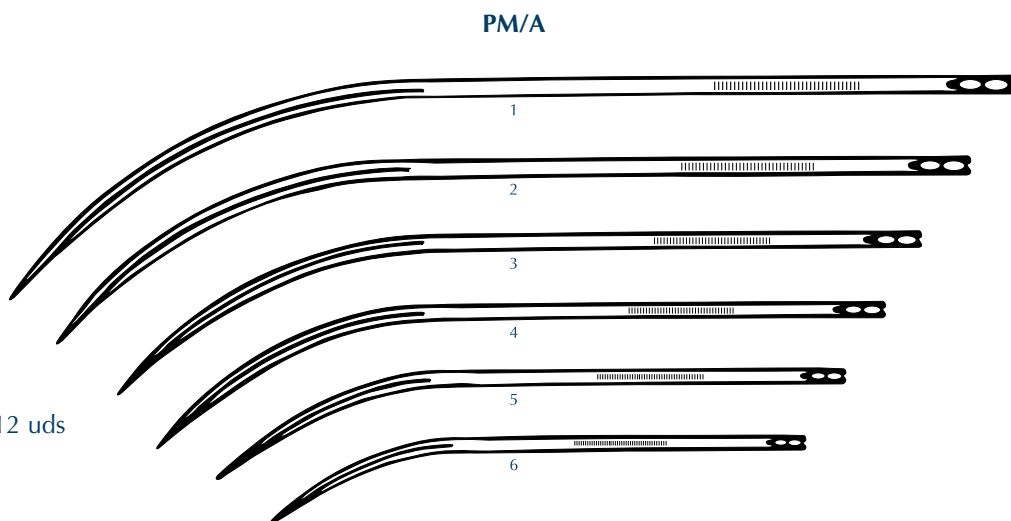

Agujas de sutura PM/S, paq. de 12 uds
"PM/S" suture needles, box of 12 units

- IS-830 N° 1
- IS-835 N° 2
- IS-840 N° 3
- IS-845 N° 4
- IS-850 N° 5
- IS-855 N° 6

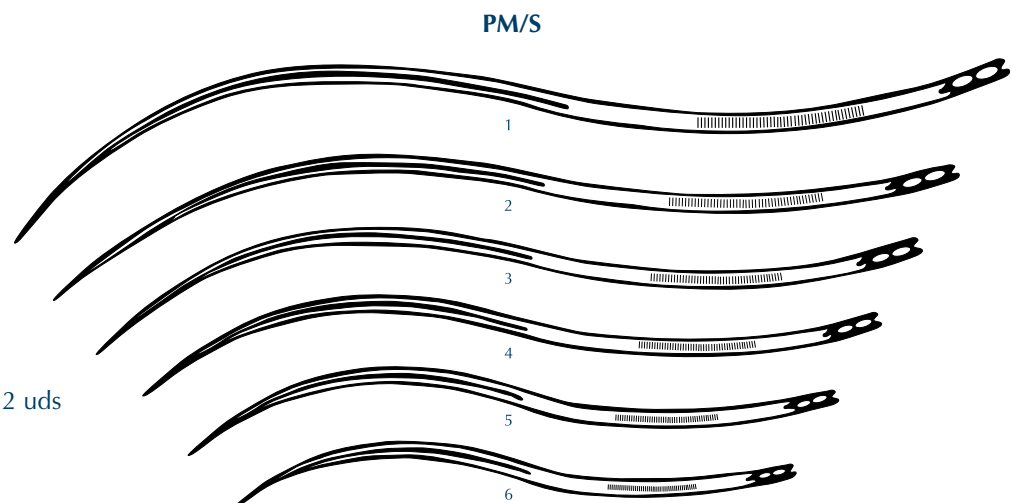

Agujas de sutura PM/K,
paq. de 12 uds
"PM/K" suture needles, box of 12 units

- IS-860 N° 1
- IS-865 N° 2
- IS-870 N° 3
- IS-875 N° 4
- IS-880 N° 5
- IS-885 N° 6

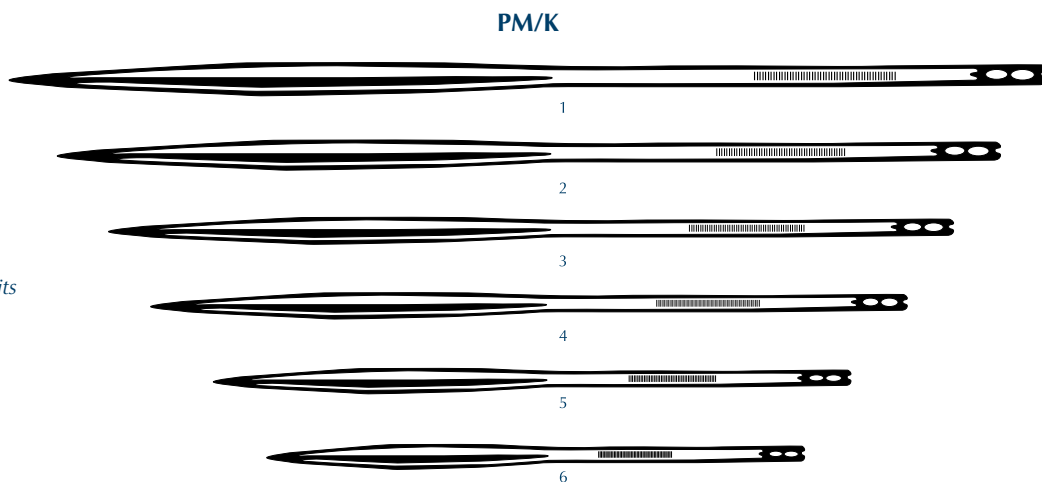

Portaguas Needle holders



IS-570 Portaguas OLSEN-HEGAR con tijera de 18 cm, de boca dura (mango dorado)

IS-571 Portaguas OLSEN-HEGAR con tijera de 14 cm, de boca dura (mango dorado)

IS-570 OLSEN-HEGAR scissors/*needle holder*, 18 cm with hard mouth (golden handle)

IS-571 OLSEN-HEGAR scissors/*needle holder*, 14 cm with hard mouth (golden handle)



Portaguas MAYO
MAYO *needle holder*

IS-550 15 cm

IS-555 18 cm

IS-560 20 cm



IS-569 Portaguas OLSEN-HEGAR con tijera de 19 cm

IS-569 OLSEN-HEGAR scissors/*needle holder*, 19cm



IS-575 Portaguas GUILLES con tijera de 16 cm

IS-575 GUILLES scissors/*needle holder*, 16 cm



Portaguas MATHIEU
MATHIEU *needle holder*

IS-535 15 cm

IS-540 18 cm

IS-545 20 cm

IS-545A 24 cm

Agujas para sutura

Suture needles



IS-520 Aguja de Gerlach de 15 cm HAUPTNER

IS-521 Aguja de Gerlach de 15 cm

IS-520 15 cm *Gerlach suture needle* HAUPTNER

IS-521 15 cm *Gerlach suture needle*



IS-530 Aguja para sutura de prolapso de 30 cm BUHNER

IS-530 30 cm prolapse *suture needle* BUHNER



IS-525 Aguja de Gerlach de 19 cm

IS-525 19 cm *Gerlach needle*

IO-145 Tenaza para ágrafes HAUPTNER

IO-145 HAUPTNER *suture wire ring applicator*



IO-140 Ágrafes níquelados grandes HAUPTNER, paq. de 100 uds

IO-140 HAUPTNER *large wire rings, nickel-plated, box of 100 units*



IS-517 Aguja para sutura REVERDIN, recta de 19,5 cm

IS-517 REVERDIN *suture needle, straight 19.5 cm*



IS-518 Aguja para sutura REVERDIN, curva de 19,5 cm

IS-518 REVERDIN *suture needle, curved 19.5 cm*

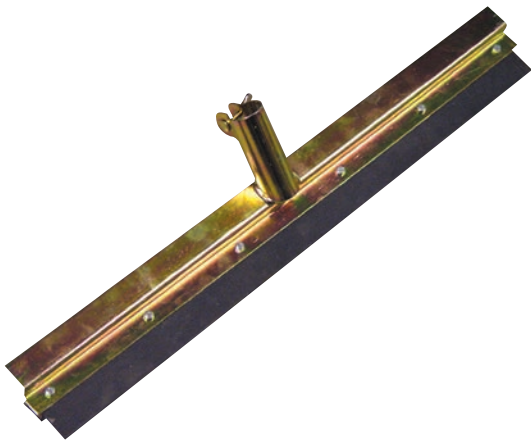

IB-770 Limpiador recto de 60 cm

IB-770 Straight *squeegee*, 60 cm

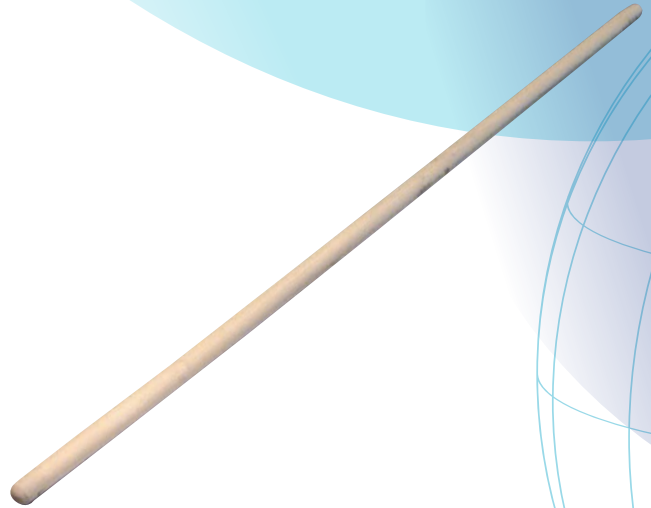

IB-785 Mango para limpiadores de 130 cm

IB-785 Wooden *handle for scrapers*, 130 cm



IB-765 Limpiador tipo circular de 55 cm

IB-765 Circular *scraper*, 55 cm



IB-760 Limpiador tipo circular de 75 cm

IB-760 Circular *scraper*, 75 cm



IB-780 Limpiador con esquinas de 55 cm

IB-780 *Dung scraper*, 55 cm



IB-775 Limpiador con esquinas de 75 cm

IB-775 *Dung scraper*, 75 cm



DS-830 Espuma INTRA Foam Cleaner de 22 kg
DS-830A Espuma INTRA Foam Cleaner bidón de 220 kg
DS-830B Espuma INTRA Foam Cleaner de 1100 kg

DS-830 INTRA Foam Cleaner, 22Kg
DS-830A INTRA Foam Cleaner, 220Kg
DS-830B INTRA Foam Cleaner, 1100Kg



DS-835 Carro de limpieza y desinfección,
 4 ruedas con válvula de 3 posiciones

DS-835 *Cleaning and disinfection trolley, 4 wheels
 with 3-position valve*



DS-451 SERBONET detergente - desengrasante
 - espumante de 25kg

DS-835 SERBONET foaming-degreasing-detergent 25kg



DS-190 Lanza limpiadora-aspiradora SPEEDY
 para limpiar bebederos y comederos

DS-190 *SPEEDY cleaning vacuum lance to clean drinkers
 and feeders*



DS-195 Pistola de espuma dosificable,
 con depósito de 2 l

DS-195 *Dosable foam gun, with 2 l tank*



IA-678 Pediluvio de desinfección, 60x40 cm

IA-678 Disinfectant footbath, 60 x 40 cm



DS-815 Desinfectante INTRA MULTI-DES GA de 5 l
DS-817 Desinfectante INTRA MULTI-DES GA de 20 l

DS-815 INTRA MULTI-DES GA Disinfectant 5 l
DS-817 INTRA MULTI-DES GA Disinfectant 20 l

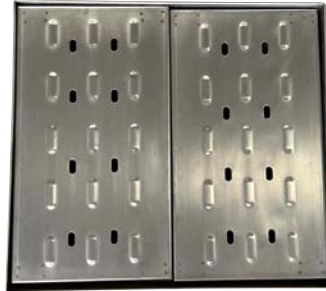

IA-676C Pediluvio acero inox doble con bandeja-muelles, 530x480x70mm de alto

IA-676C Double stainless steel footbath with spring tray, 530x480x70mm high

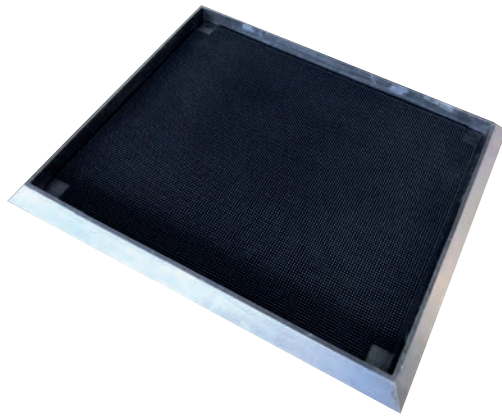

IA-677A Pediluvio de desinfección caucho 28 l, 985 x 810 x 50 mm,

IA-677A Rubber disinfection footbath, 28 l, 985 x 810 x 50 mm



IA-676A Pediluvio acero inox con bandeja-muelles, 530x480x45mm de alto
IA-676B Pediluvio acero inox con bandeja-muelles, 530x480x70mm de alto

IA-676A Stainless steel footbath with springs tray, 530x480x45mm high

IA-676B Stainless steel footbath with springs tray, 530x480x70mm high

Alfombra para desinfección
Disinfectant rug

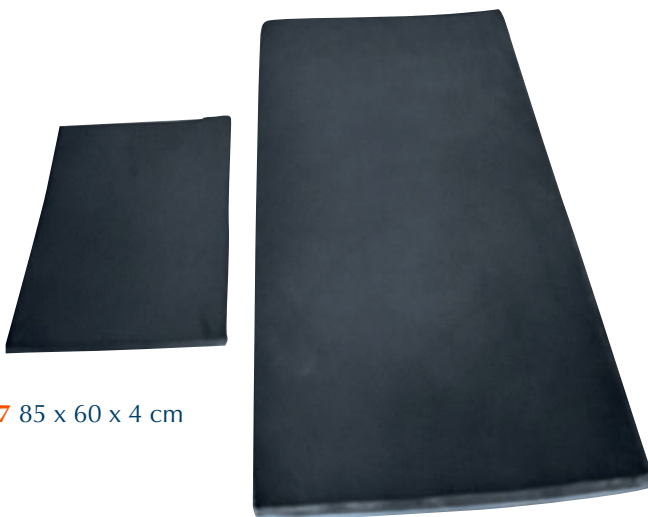

IA-677 85 x 60 x 4 cm

IA-678A 180 x 90 x 10 cm

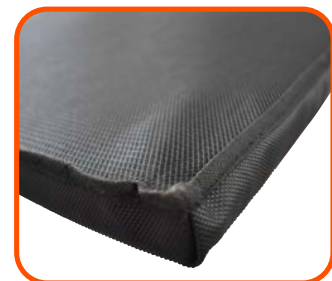

Limpieza Cleaning



IB-750 Limpiador de calzado desinfectante para entrada en granjas (modelo acero inoxidable)

IB-750 Disinfectant cleaner for shoes (stainless steel model).



IB-751 Limpiador de calzado para entrada en granjas (modelo pintado)

IB-751 Disinfectant cleaner for shoes (painted model)



IB-755 Descalzador de botas

IB-755 Boot remover



DS-885 Pediluvio super-kombi para cascos (2 x 0,80 m), 200 l

DS-885 Super-kombi footbath for hoofs (2 x 0.80 m), 200 l



DS-887 Pediluvio para ovino de 3000x380x190

DS-887 Footbath for sheep 3000x380x190



IB-800 Cepillos con muelle para la limpieza e higiene animal

IB-800 Brush with spring for animal cleaning



IB-805 Cepillos con muelle y depósito para la limpieza e higiene animal

IB-805 Brushes with spring and tank for animal cleaning



IE-150 Esquiladora OSTER A-5 de 1 vel.
IE-155 Esquiladora OSTER A-5 de 2 vel.

IE-150 OSTER A-5 clipper (1-speed)
IE-155 OSTER A-5 clipper (2-speed)



IE-170
SIZE 40
 corte: 0,25 mm
 especial cirugía
 cutting: 0.25 mm
 for surgery use

CABEZALES PARA ESQUILADORAS OSTER A-5 Y POWER PRO
OSTER A-5 AND POWER PRO CLIPPER HEADS



IE-170J
SIZE 50
 corte: 0,2 mm
 microcirugía
 cutting: 0.2 mm
 microsurgery



IE-170E
SIZE 30
 corte: 0,5 mm
 cara, pies, rabo
 cutting: 0.5 mm
 face, feet, tail



IE-170K
SIZE 15
 corte: 1,2 mm
 caniches, perros
 lanosos, uso general
 cutting: 1.2 mm
 caniche, big hair quantity,
 general use



IE-170A
SIZE 10
 corte: 1,6 mm
 uso general
 cutting: 1.6 mm
 general use



IE-170R
SIZE 10W
 corte: 2,4 mm
 cara, pies, rabo
 cutting: 2.4 mm
 face, feet, tail



IE-170P
SIZE 9
 corte: 2 mm
 acabados cortos
 y uniformes
 cutting: 2 mm
 short and uniform cutting



IE-170I
SIZE 8 1/2
 corte: 2,8 mm
 uso general
 especial terriers
 cutting: 2.8 mm
 general use,
 special for terriers



IE-170B
SIZE 07
 corte: 3,2 mm
 cuerpo caniche,
 terrier, cocker
 cutting: 3.2 mm
 caniche body,
 terrier, cocker



IE-170D
SIZE 5
 corte: 6,3 mm
 cuerpo caniche,
 terrier, etc.
 cutting: 6.3 mm
 caniche, terrier body, etc...



IE-170C
SIZE 4
 corte: 9,5 mm
 cuerpo, grandes
 cantidades de pelo
 cutting: 9.5 mm
 body, big hair quantity



IE-170H
SIZE 7 F
 corte: 3,2 mm
 acabados
 cutting: 3.2 mm
 finishing touch



IE-170G
SIZE 5 F
 corte: 6,3 mm
 acabados
 cutting: 6.3 mm
 finishing touch



IE-170F
SIZE 4F
 corte: 9,5 mm
 acabados
 cutting: 9.5 mm
 finishing touch



IE-170M
SIZE 5/8
 corte: 0,8 mm
 ancho: 14 mm
 acabados precisos
 cutting: 0.8 mm
 width: 14 mm
 accurate cutting



IE-170N
SIZE 7/8
 corte: 0,8 mm
 ancho: 19 mm
 acabados precisos
 cutting: 0.8 mm
 width: 19 mm
 accurate cutting

Esquiladoras Clippers



IE-165 Esquiladora OSTER A-5 recargable, Power Pro

IE-165 OSTER A-5 **clipper**, rechargeable, Power Pro



IE-109B Esquiladora de baterías MOSER ARCO PRO

IE-109B MOSER ARCO PRO battery **clipper**



IE-162 Esquiladora con batería de larga duración MOSER AVALON

IE-162 MOSER AVALON **clipper** with long lasting battery



IE-160A Esquiladora recargable OSTER ARTISAN

IE-160A OSTER ARTISAN rechargeable **clipper**



IE-163 Esquiladora OSTER PRO 3000i, de baterías

IE-163 OSTER PRO 3000i battery **clipper**



IE-158 Esquiladora ANDIS ULTRAEDGE AGC SUPER, 2 velocidades

IE-158 ANDIS ULTRAEDGE AGC SUPER **clipper**, 2 speeds



IE-161 Esquiladora MOSER MAX 45, de dos velocidades

IE-161 Moser MAX45 2 speeds **clipper**



IE-159 Esquiladora ANDIS a baterías PULSE ZR II (5 velocidades)

IE-159 ANDIS battery **clipper** PULSE ZR II (5 SPEED)

* EN ALGUNOS MODELOS DE ESQUILADORAS, EL FABRICANTE NO INCLUYE EL CABEZAL Y DEBERÁ ADQUIRIRSE APARTE
* IN SOME MODELS OF CLIPPERS, THE MANUFACTURER DOES NOT INCLUDE THE HEAD AND IT MUST BE PURCHASED SEPARATELY



IE-105 Esquiladora para ovejas
HAUPTNER

IE-105 HAUPTNER sheep clipper



IE-100 Esquiladora para vacas
HAUPTNER
IE-107 Esquiladora para caballos
HAUPTNER

IE-100 HAUPTNER cattle clipper
IE-107 HAUPTNER horse clipper



IE-145 Esquiladora para vacuno
RINDER, de 330 W (alemana)

IE-145 RINDER clipper for cattle, 330 w.
(german model)



IE-140 Esquiladora para ovejas MASTER,
de 330 W

IE-140 MASTER clipper for sheep, 330 w.



IE-135 Esquiladora para vacuno y
perros grandes CLIPMASTER

IE-135 CLIPMASTER cattle and big dogs
clipper



IE-130 Esquiladora para ovejas
SHEARMASTER

IE-130 SHEARMASTER sheep clipper



IE-176 Lubricante para cuchillas
esquiladora "BLADE-LUBE"

IE-176 "BLADE-LUBE" shearing blade
lubricant



IE-180 Spray limpiador/lubricante/
refrigerante COOLSPRAY para
esquiladora

IE-180 Lubricant, cleaning and coolant
spray for clippers, COOLSPRAY



IE-175 Limpiador cabezales-cuchillas
esquiladora BLADE-WASH

IE-175 BLADE WASH cleaning solution for
clipper heads



IE-147 Cabezal esquilador colas vacuno TAILWELL 2

IE-147 TAILWELL 2 cattle tail clipper head

Esquiladoras Clippers



IE-205 Esquiladora manual para ovino

IE-205 Hand sheep clipper



IE-210 Esquiladora manual para vacuno

IE-210 Hand cattle clipper



IE-215 Esquiladora manual dos manos para ovino

IE-215 2 hands sheep clipper



IE-220 Esquiladora manual dos manos para vacuno

IE-220 2 hands cattle clipper



Tijera para esquilar

- IE-200** Niquelada recta
- IE-200A** Pintada recta
- IE-201** Niquelada curva
- IE-201A** Pintada curva

Sheep shears

- IE-200** Straight nickel-plated
- IE-200A** Straight painted
- IE-201** Curved nickel-plated
- IE-201A** Curved painted



IE-225 Esquiladora manual minicorte estrecho

IE-230 Esquiladora manual minicorte ancho

IE-225 Hand clipper, narrow cutting

IE-230 Hand clipper, wide cutting



Spray para marcar ovino RAIDEX, 500 ml
RAIDEX sheep marking spray

- ID-270** Rojo / Red
- ID-274** Amarillo / Yellow
- ID-271** Azul / Blue
- ID-275** Violeta / Violet
- ID-272** Verde / Green
- ID-275A** Rosa / Pink
- ID-273** Negro / Black
- ID-275B** Naranja / Orange



IC-146 Cortapezuñas articulado

IC-146 Articulated hoof cutter

IC-148 Cortapezuñas de corte lateral de 60 cm

IC-148 Hoof cutter, lateral cutting, 60 cm



IC-148A Tenaza remachadora para pezuñas, 35 cm

IC-148A Hoof nail clinch, 35 cm



IC-148B Martillo para herraje de pezuñas con cabeza reforzada

IC-148B Heavy duty shoeing hammer



PA-390 Venda de alquitrán de 25 m

PA-390 Tar bandage, 25 m



IC-147 Tenaza para cascos, con dientes

IC-147 hoof plier, with teeth

Cortapezuñas / Pediluvio

Hoof knives / Footbath



IC-145A Legra para pezuñas

IC-145A Hoof knife



IC-149 Tijera para cascos lisa

IC-149 Non serrated hoof cutter



IC-149B Tijera para cascos reforzada FELCO, mango rotativo

IC-149BB Tijera para cascos-pezuñas reforzada FELCO

IC-149B FELCO hoof scissors, rotative

IC-149BB FELCO hoof scissors



IC-145D Disco de metal para cascos, de 6 cuchillas

IC-145D Metal disc for hoofs, 6 blades



Disco abrasivo para pezuñas
Abrasive hoof disc

IC-145E 115 mm ø

IC-145F 127 mm ø

IC-145G 178 mm ø



IC-149A Tijera para cascos dentada

IC-149A Serrated hoof cutter



IC-135A

IC-140A

IC-143A

IC-141A

IC-142A

IC-135A Legra derecha de corte doble, mango de madera (dorso cortante)

IC-140A Legra izquierda de corte doble, mango de madera (dorso cortante)

IC-141A Legra de corte derecho, mango de madera

IC-142A Legra de corte izquierdo, mango de madera

IC-143A Legra derecha de corte doble, mango de madera (total hoja)

IC-135A Right hand knife, double sided cutting, wooden handle

IC-140A Left hand knife, double sided cutting, wooden handle

IC-141A Right hand knife, wooden handle

IC-142A Left hand knife, wooden handle.

IC-143A Right hand knife, all blade cutting, wooden handle



DS-880 PEDILUVIO INTRA BATH doble 2 partes mas gradilla inox

DS-880 INTRA BATH footbath double 2 parts plus stainless steel rack



DS-885 Pediluvio super-combi para cascos, 200 l (2 x 0,80 m)

DS-885 Super-combi footbath 200 l (2 x 0.80 m)

DS-887 Pediluvio para ovino de 3000x380x190

DS-887 Footbath for sheep 3000x380x190

La solución para los problemas de pezuñas THE SOLUTION FOR HOOF PROBLEMS



DS-875 INTRA HOOF-FIT BATH 10 l
DS-876 INTRA HOOF-FIT BATH 20 l



DS-878 INTRA HOOF-FIT BATH
de 10 l, "ESPECIAL OVINO"

DS-878 INTRA HOOF-FIT 10 l, "special sheep"



DS-867 INTRA HOOF-FIT spray 10 l
DS-868 INTRA HOOF-FIT spray 20 l

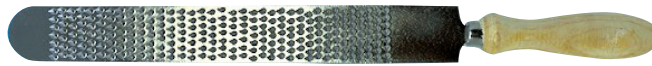

IC-147A Lima para cascos de 60 cm

IC-147A 60 cm *hoof file*



DS-850 Spray INTRA microderm de 250 ml

DS-850 INTRA microderm spray 250 ml



Vendas cohesivas INSERFIX
INSERFIX cohesive bandages

PA-325 de 10x450, azul caja de 12 u

PA-326 de 10x450, verde caja de 12 u

PA-325 10x450, blue box of 12 units

PA-326 10x450, green box of 12 units



DS-855 Gel INTRA Hoot-fit bote de 330 ml (incluye pincel)

DS-855 INTRA Hoot-fit gel 330 ml bottle (includes brush)



Destetador de plástico con cierre de palomilla
Plastic milk sucking preventor with butterfly adjustment nut

- IT-133** Pequeño / *Small*
- IT-133A** Mediano / *Medium*
- IT-133B** Grande / *Large*



IT-131 Destetador de plástico sin cierre, amarillo
IT-131 Yellow plastic milk sucking preventor without lock



IT-134A Destetador de caucho mediano
IT-134A Medium rubber milk sucking preventor



IT-134B Destetador de caucho grande
IT-134B Large rubber milk sucking preventor



IT-134 Destetador de caucho pequeño
IT-134 Small rubber milk sucking preventor



IT-130 Destetador de aluminio
IT-130 Aluminium milk sucking preventor



Destetador metálico para tenaza
Metallic milk sucking preventor

- IT-129A** Pequeño / *Small*
- IT-129B** Mediano / *Medium*
- IT-129C** Grande / *Large*



IT-129 Tenaza para colocar destetadores metálicos
IT-129 Metallic milk sucking preventors applicator

Destetadores / Narigueras Milk sucking preventors / Bull holders



IN-117 Nariguera con muelle espiral,
12 cm

IN-117 Bull holder with spring, 12 cm



IN-114 Nariguera con muelle, 17 cm

IN-114 Bull holder with spring, 17 cm



IN-110 Nariguera según HARMS

IN-110 HARMS bull holder



IN-115 Nariguera para sujeción con lazo

IN-115 Bull holder with holes to use with a rope



IN-112 Nariguera EISENHUT, 44 cm

IN-112 EISENHUT bull holder, 44 cm



IN-113 Nariguera con mango, 44 cm

IN-113 Bull holder with handle, 44 cm



Anilla nasal niquelada
Nickel-plated steel nose ring

- IN-096** 70 mm (diámetro interior)
- IN-095** 60 mm (diámetro interior)
- IN-094** 55 mm (diámetro interior)
- IN-093** 45 mm (diámetro interior)

- IN-096* 70 mm (inner diameter)
- IN-095* 60 mm (inner diameter)
- IN-094* 55 mm (inner diameter)
- IN-093* 45 mm (inner diameter)

IN-100 Anilla nasal HAUPTNER
en acero pulido, 52 mm

IN-100 HAUPTNER nose ring 52 mm,
bright steel



IN-107 Tenaza para anilla nasal de vacuno,
45, 55 y 60 mm

IN-107 Applicator for nose rings 45, 55 and 60
mm

IN-119C Tenaza para ágrafes y grapas
HAUPTNER

IN-119C HAUPTNER wire pig staples
applicator

Grapas para morro cerdo HAUPTNER
HAUPTNER wire pig staples

- IN-119** Pequeñas, paq. de 100 uds
- IN-119A** Medianas, paq. de 100 uds

- IN-119* Small, box of 100 units
- IN-119A* Medium, box of 100 units



- IN-108 Tenaza** para anilla nasal de cerdo de 30 mm
- IN-109 Tenaza** para anilla nasal de cerdo de 40 mm
- IN-090 Anilla nasal** de 40 mm ø, exterior cromada
- IN-090A Anilla nasal** de 40 mm ø, exterior niquelada
- IN-092 Anilla nasal** de 30 mm ø, exterior

- IN-108 Plier* for pig nose rings, 30 mm
- IN-109 Plier* for pig nose rings, 40 mm
- IN-090 Chromed nose ring*, 40 mm outer diameter
- IN-090A Nicked nose ring* 40 mm outer diameter
- IN-092 Nose ring*, 30 mm outer diameter



IO-146 Tenaza para ágrafes de
sutura y grapas morro n° 3 y 4,
paq. de 100 uds

IO-146 Wire pig staples applicator n.3
and n.4, box of 100 units

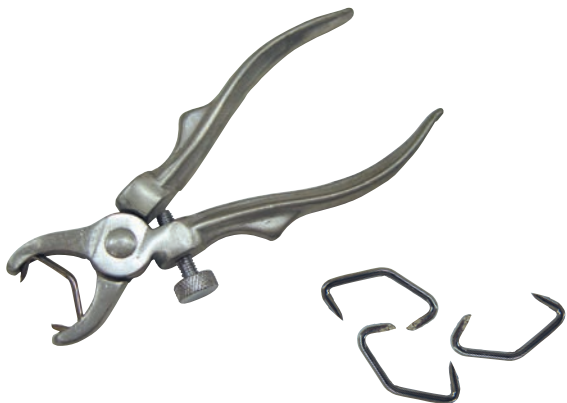

Grapas para morro cerdo
Wire pig staples

- IN-118A** N° 3, paq. de 100 uds
- IN-118B** N° 4, paq. de 100 uds
- IN-118C** N° 5, paq. de 100 uds
- IN-118D** N° 6, paq. de 100 uds

- IN-118A* n.3, box of 100 units
- IN-118B* n.4, box of 100 units
- IN-118C* n.5, box of 100 units
- IN-118D* n.6, box of 100 units

IN-118 Tenaza grapas para morro cerdo universal

IN-118 Universal wire pig staples applicator

Anillas nasales / Collares

Nose rings / Halters



IN-124E Cabezada de nailon para terneros

IN-124E Nylon halter for calves



IN-124F Cabezada para terneros y vacas

IN-124F Halter for calves and cows



IN-124G Cabezada para vacas

IN-124G Halter for cows



IN-124H Cabezada para vacas con cadena

IN-124H Halter for cows with chain



IN-124K Collar sin cadena para vacas

IN-124K Necklace without chain for cows



IN-124L Collar con cadena de fijación para vacas

IN-124L Necklace with chain for cows

IN-124M Collar con cadena de doble fijación para vacas

IN-124M Necklace with double chain for cows

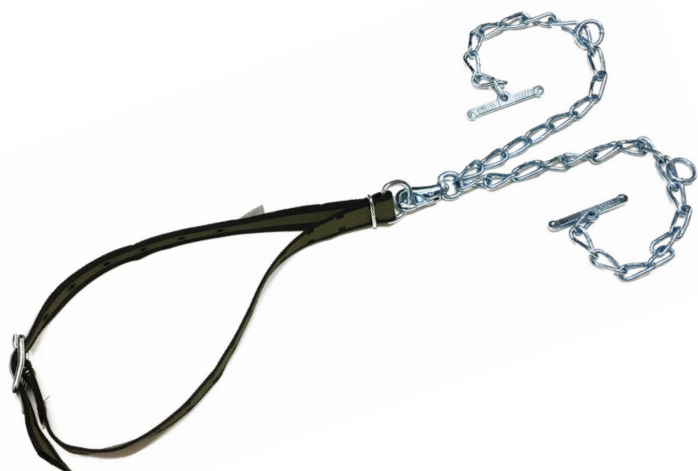

IN-128 Elevador de vacas

IN-128 Cow lifter



IN-128C Elevador de cabezas de vacuno

IN-128C Cow head lifter



IN-128E Elevador de vacas (1.500Kg)

IN-128 Cow lifter (1.500Kg)



IN-125 Traba evitacoces

IN-125 Anti-kick bar



IT-108 Abrebocas de metal, mod. Schulze para vacuno y equino

IT-108 Schulze metal mouth gag for cattle and horse



IN-124A Pinza para sujetar patas, modelo cerrado

IN-124A Tendon clamp, closed model

IN-124 Pinza para sujetar patas, modelo abierto

IN-124 Tendon clamp, open model

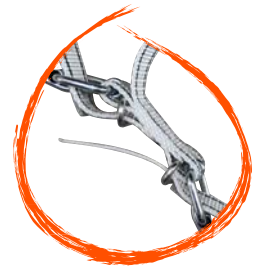

IN-124C Trabón de nailon para sujetar patas, sin regulación

IN-124C Cattle hobble standard

IN-124D Trabón de nailon para sujetar patas, regulable

IN-124D Cattle hobble adjustable

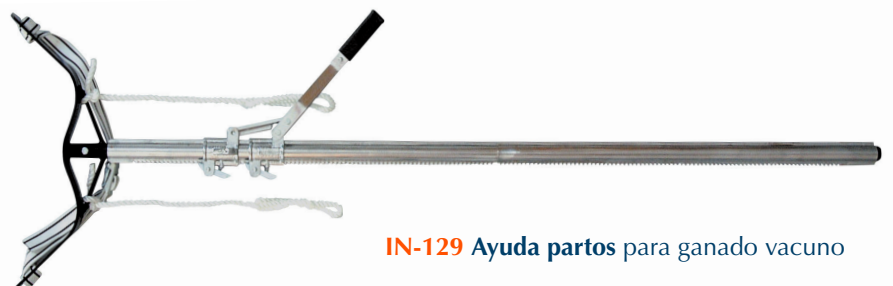

IN-129 Ayuda partos para ganado vacuno

IN-129 Cattle labour's help

Elevadores / Trabones

Cow lifters / Hobbles



IN-148 Bastón metálico para sujetar patas de 95 cm
IN-148A Bastón metálico para sujetar patas de 125 cm

IN-148 95 cm leg metallic crook
IN-148A 125 cm leg metallic crook



IN-149 Bastón metálico para sujetar cuello y patas, 135 cm

IN-149 135 cm. leg and neck metallic crook

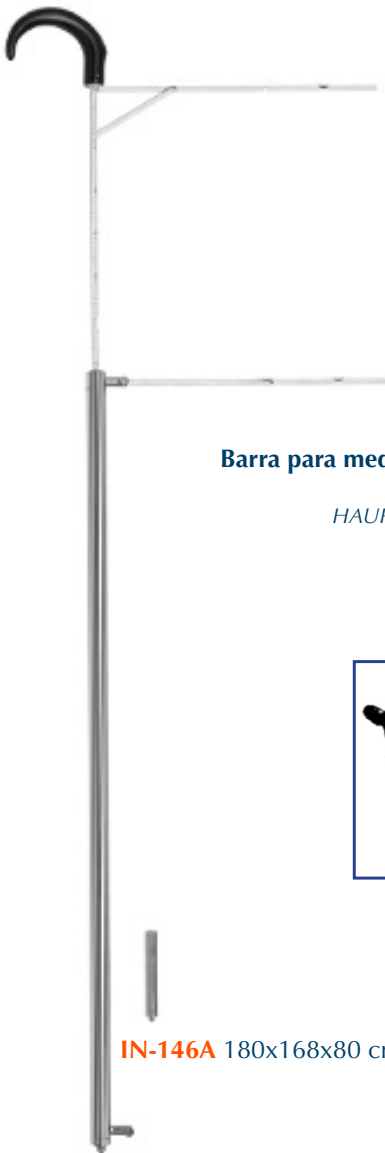

Barra para medición de vacuno HAUPTNER

HAUPTNER measuring stick

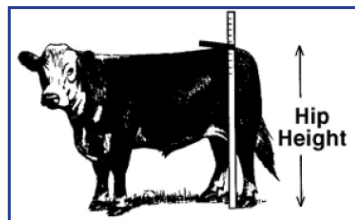

IN-146A 180x168x80 cm

IN-146 3 - 218



IN-124B Pinza para sujetar colas

IN-124B Tail bridle



IN-145A Contador analógico manual

IN-145A Analog counter



IN-145 Cinta métrica para pesar ganado

IN-145 Weighband for cattle and pig



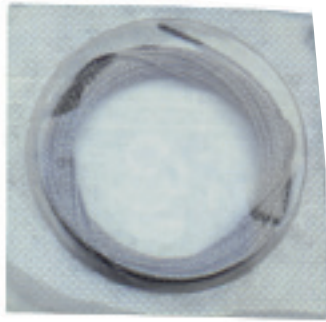

IC-155 Sirga para cuernos, 12 m
IC-160 Sirga para cuernos, 3,6 m

IC-155 Dehorning saw wire, 12 m
IC-160 Dehorning saw wire, 3.6 m



IC-162 Mango para sirga de descornar (par)
IC-162 Saw wire handle (by pairs)



Descornador manual metálico BARNES

BARNES metal dehorner

IC-153 33 cm
IC-154 43 cm

IC-168F Descornador a baterías completo Buddex

IC-168F Complete battery dehorner "Buddex"



IC-167 Descornador portátil recargable con carga de gas

IC-167 Portable, rechargeable dehorner with gas cartridge



Descornadores Dehorners



Boquillas para descornador
Dehorner tips

IC-168C 25 mm **IC-168B** 20 mm **IC-168A** 15 mm

IC-168 Descornador eléctrico tipo revólver (incluye dos boquillas de 25 mm y 15 mm)

IC-168 *Electric dehorner, pistol handle (with 2 tips of 25 mm and 15 mm)*



IC-166 Lápiz cauterizador para descornar

IC-166 *Dehorning caustic pen*



IC-168R Descornador eléctrico de 250 W, con boquilla de 17 mm

IC-168R *Electric dehorner 250W (with tip of 17 mm)*



IC-164 Pasta para descornar en jeringa dosificadora

IC-164 *Dehorner paste in dosing syringe*



IC-116B Tenaza descornadora elastrator XL para vacuno

IC-116C Gomas elastrator XL para vacuno, paq. de 25 uds

IC-116B *Elastrator XL dehorner pincers for cattle*

IC-116C *Elastrator XL rubber bands for cattle, pack of 25 units*



IT-100 Trocar de tornillo, material plástico

IT-100 Plastic screw trocar



IT-105 Trocar, mango de madera, 12 cm x 7 mm

IT-105 Trocar, wooden handle, 12 cm x 7 mm



IT-106 Trocar mango metal, 9 cm x 5 mm

IT-107 Trocar mango metal, 12 cm x 6 mm

IT-106 Metal handle trocar, 9 cm x 5 m
IT-107 Metal handle trocar, 12 cm x 6 m

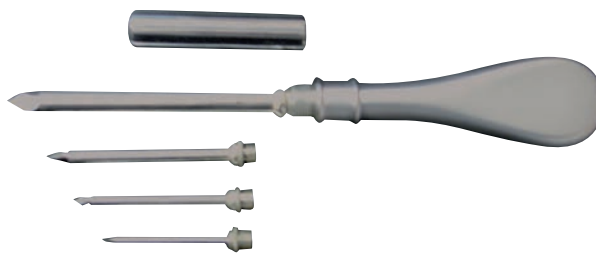

IT-103 Trocar universal metálico (4 tamaños en un set)

IT-103 Universal sheep trocar (4 sizes in one set)

IT-120 Bomba estomacal

IT-120 Stomach pump



Sonda nasogástrica
Nasal-gastric probes

- IT-109** 9 x 2.100 mm
- IT-109A** 13 x 2.700 mm
- IT-109B** 16 x 2.700 mm
- IT-109C** 19 x 3.000 mm



IT-115 Reanimador de terneros

IT-120 Calf Resuscitator



IT-124 Abrebocas para sonda esofágica grande
IT-124A Abrebocas para sonda esofágica pequeña

IT-124 Mouth gag for probangs, large
IT-124A Mouth gag for probangs, small

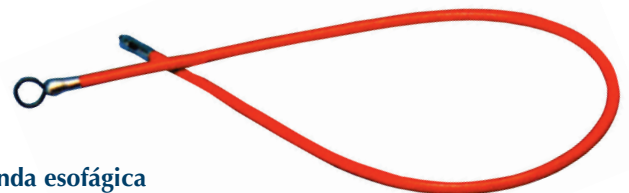

Sonda esofágica
Probangs

- IT-123** Para vacas, 170 cm
- IT-123A** Para vacas, 170 cm con abrebocas de madera
- IT-122** Para terneros, 130 cm
- IT-122A** Para terneros, 130 cm con abrebocas de madera

IT-123 170 cm for cows
IT-123A 170 cm for cows, with wooden mouth gag
IT-122 130 cm for calves
IT-122A 130 cm for calves with wooden mouth gags

Trocars / Sondas / Imanes

Trocars / Probes / Magnets

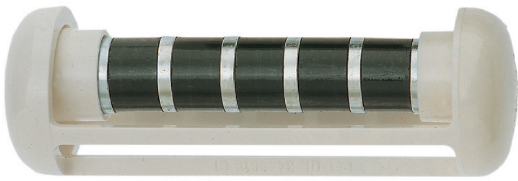

IT-142 Imán esofágico blanco curativo MEDVET super II

IT-142 MEDVET super II healing white ruminal magnet

Introduccion de imanes Magnet introducer

IT-145 Rígido STARVET

IT-145 STARVET rigid



IT-146 Flexible HAUPTNER

IT-146 HAUPTNER flexible



IT-147 Flexible STARVET

IT-147 STARVET flexible



IT-135 Imán esofágico STARVET, forma de jaula

IT-135 STARVET ruminal magnet, cage form

Para prevenir y tratar la indigestión traumática del ganado debido a cuerpos extraños ferromagnéticos en la panza recomendamos la introducción de un imán STARVET antes del primer parto o a la edad de 18 meses. El imán STARVET es eficaz también en el tratamiento de ataques agudos de indigestión traumática por su capacidad de aislar cuerpos extraños magnéticos.

In connection with prevention and treatment of traumatic indigestion with cattle-caused by ferromagnetic foreign bodies in rumen-it is recommended to introduce one STARVET magnet before first calving or at an age of 1 1/2 year. STARVET magnet is also effective in the treatment of acute attacks of traumatic indigestion through its ability to retract and isolate foreign bodies of ferromagnetic material.





IT-175 Cubo para corderos con 6 tetinas, 11 l

IT-175 11 l feeding bucket for lambs, with 6 teats



IT-171 Válvula de aluminio para tetina corderos

IT-172 Válvula de plástico para tetina corderos

IT-171 Aluminium valve for lamb teat

IT-172 Plastic valve for lamb teat

Tetina de recambio para corderos
Lambs spare teat

IT-170A Tetina de caucho calidad extra

IT-170B Tetina para biberón

IT-170A Rubber teat, extra quality

IT-170B Feeding bottle spare teat



IT-170A



IT-170B



IT-205 Botella biberón para corderos, 1 l

IT-215 Botella biberón para corderos, 500 ml

IT-205 Lamb feeding bottle, 1 l

IT-215 Lamb feeding bottle, 500 ml



IU-185 Separador de leche QUARTER MILKER, bidón de 8 l

IU-185 QUARTER MILKER, 8 l container



IT-230 Calentador de leche "display digital" de 2.300 W

IT-235 Digital display milk warmer, 2.300 W.



IT-235 Calentador de leche eléctrico de 2.300 W

IT-235 Electric milk warmer, 2.300 W.



IT-225A Tetina de recambio roja, para botella de biberón de cordero

IT-225A Red spare teat for lamb feeding bottle



IT-400 Carro de leche con bomba y mezclador, 170 l

IT-400 Milk trolley with pump and mixer, 170 l



IT-401 Carro de leche Inox con bomba, mezclador, y pasteurizador, 200 l

IT-401 Milk trolley stainless steel with pump, mixer and pasteuriser, 200 l

Cubos / Tetinas / Carros de leche

Buckets / Teats / Milk trolleys



IT-160 Cubo de plástico completo con tetina
IT-161 Cubo de plástico completo sin tetina

IT-160 Complete plastic bucket, with teat
IT-161 Complete plastic bucket, without teat



IT-166 Válvula completa de recambio para cubo

IT-166 Complete spare valve for bucket



IT-165A Tetina terneros de caucho calidad extra para cubo

IT-165A Calf rubber teat for bucket, extra quality



IT-163 Soporte para cubo terneros

IT-163 Calf bucket holder



IT-260 Cubo completo gris con tetina roja
IT-264 Tetina terneros roja para cubo gris o verde

IT-260 Calf feeding grey bucket with red teat and valve
IT-264 Spare red teat for grey and green bucket



IT-167 Tetina terneros, para cubo negro
IT-167A Tetina terneros de caucho calidad extra, para cubo verde
IT-225 Tetina terneros de caucho extra, para botella

IT-167 Calf teat for black bucket
IT-167A Calf teat for green bucket, extra quality rubber
IT-225 Calf teat for bucket, extra quality rubber for bottle



IT-262 Válvula de recambio para cubo gris

IT-262 Spare valve for grey bucket



IT-224 Tetina de recambio roja, para botella biberón de terneros

IT-224 Spare red teat for milk bottle

IT-200 Botella biberón para terneros, 1 l
IT-210 Botella biberón para terneros, 500 ml

IT-200 Calf feeding bottle, 1 l
IT-210 Calf feeding bottle, 500 ml





IT-275 Cubo doble naranja con asa de 10 l completo para terneros

IT-275 Double orange bucket for calves, 10 l

IT-280 Tetina para cubo doble

IT-280 Spare teat for double bucket

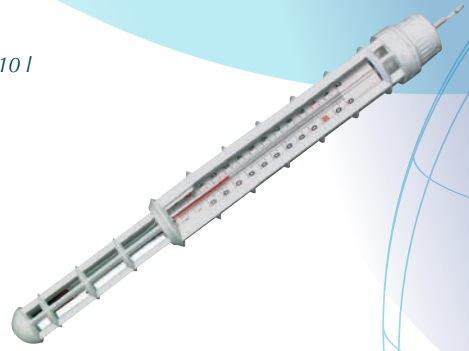

DG-118A Termómetro para líquidos con protector de plástico, 120 °C

DG-118A Thermometer for liquids with plastic protection. 120 °C



IT-199A Soporte para botella biberón para terneros

IT-199A Calf feeding bottle holder



IT-198 Tetina para botella biberón de terneros, 2 y 3 l

IT-198 Teat for calf feeding bottle, 2 and 3l



IT-199 Botella biberón de 2 l para terneros
IT-199B Botella biberón de 3 l para terneros

IT-199 Calf feeding bottle, 2 l
IT-199B Calf feeding bottle, 3 l



IT-196 Botella con válvula para terneros, 4 l

IT-196 Feeding bottle with valve for calves, 4 l



IT-180 Tetina flotante para terneros

IT-180 Floating calf dummy

IT-185 Recambio para tetina flotante

IT-185 Spare teat for floating dummy



Cubos / Tetinas / Biberones

Buckets / Teats / Feeding bottles



IT-380 Tetina de terneros negra Milk Bar
IT-380A Tetina terneros negra para Milk Bar
 (con posición)

IT-380 Milk Bar black calf teat
IT-380A Milk Bar black calf teat (with position)



IT-380



IT-380A



Cubo alimentador de leche Milk Bar

Milk Bar freeder bucket

IT-375 de 6 tetinas 36 l
IT-376 de 10 tetinas 60 l
IT-377 de 12 tetinas 90 l

IT-375 6 teat 36 l
IT-376 10 teat 60 l
IT-377 12 teat 90 l



Cubo alimentador de leche Milk Bar

Milk Bar freeder bucket

IT-385 de 5 compartimentos 12,5 l
IT-386 de 10 compartimentos 25 l

IT-385 5 compartment 12,5 l
IT-386 10 compartment 25 l



IT-370 Cubo alimentador Milk Bar Nodriza 20 tetinas 120 L.

IT-370 Milk Bar freeder bucket Nurse 20 teats 120L.

IT-390 Alimentador con separación de terneros azul de 5 tetinas

IT-390 5 teat blue calf split feeder



IT-285 Kit de ordeño manual para ovino-caprino

IT-285 Sheep and goat milking pump



Filtros para leche cosidos

Milk filters socks stitched

IT-295 250 x 57/60 mm, caja de / box of 250 uds / pcs

IT-300 320 x 57/60 mm, caja de / box of 250 uds / pcs

IT-305 455 x 57/60 mm, caja de / box of 250 uds / pcs

IT-307 455 x 75/78 mm, caja de / box of 200 uds / pcs

IT-310 530 x 57/60 mm, caja de / box of 250 uds / pcs

IT-315 620 x 57/60 mm, caja de / box of 250 uds / pcs

IT-316 620 x 75/78 mm, caja de / box of 200 uds / pcs

IT-321 820 x 75/78 mm, caja de / box of 200 uds / pcs

IT-322 610 x 95/98 mm, caja de / box of 200 uds / pcs



Jarra de plástico para leche
Plastic jar for milk

IA-567 2 l

IA-569 3 l

IA-568 5 l



IT-325 Filtros para leche 200 mm ø, caja de 200

IT-327 Filtros para leche 240 mm ø, caja de 200

IT-325 Milk filters 200 mm ø, box of 200 pcs

IT-327 Milk filters 240 mm ø, box of 200 pcs



IT-340 Colador de leche completo en aluminio, 300 ml

IT-340 Aluminium milk strainer, 300 ml



IT-341 Juego de filtros colador de leche

IT-341 Milk strainer spare filters set



IT-350 Kit 10 bolsas calostro + tetina + sonda

IT-350 Kit 10 colostrum bags + teat + probe

IT-360 Manta abrigo térmico terneros premium de 70cm

IT-360 Premium thermal blanket-coat for calves of 70cm



AG-308 Sonda para calostro lechones/lechales

AG-308 Colostrum probe for piglets and calves

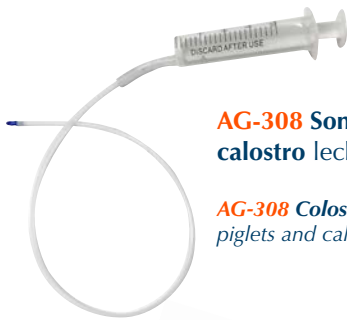

IT-125 Calf drencher con sonda flexible 2 l

IT-125 Calf drencher with flexible probe



IT-218 botella biberón 250 ml con sonda para calostro de corderos

IT-218 Feeding bottle 250 ml with probe for colostrum lambs



IT-128D Botella de 4 l speedy drencher con sonda y válvula

IT-128D 4 l speedy drencher bottle with probe and valve



IT-127 Calf drencher con sonda rígida 2 l

IT-127 Calf drencher with rigid probe



IT-128B Calf drencher profi 4 l, con sonda flexible 105 cm

IT-128B Calf drencher profi 4 l with flexible probe 105 cm



IU-130 Evacuador de tetas
sistema danés

IU-130 Danish *teat splitter*



IU-125 Evacuador de tetas según
HUG, cabeza cortante de 16cm

IU-125 HUG *teat splitter*, 16cm cutting head



IU-131 Evacuador de tetas suizo

IU-131 Swiss *teat splitter*



Catéter FUERSTEMBERG
FUERSTEMBERG catheter

IU-100 2 mm
IU-105 2'5 mm
IU-110 3 mm

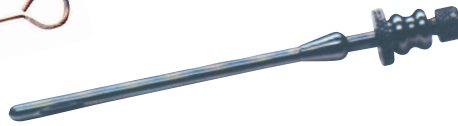

IU-115A Cánula mamaria BARTELS de 6 cm x 2,5 mm

IU-120A Cánula mamaria BARTELS de 8 cm x 2,5 mm

IU-115A BARTELS *teat cannula*, 6 cm x 2.5 mm

IU-120A BARTELS *teat cannula*, 8 cm x 2.5 mm

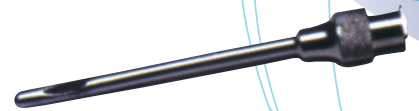

IU-122 Cánula mamaria metálica
cono Luer Lock redondo, 70 mm

IU-122 *Teat cannula*, Luer Lock, 70 mm



IU-147 Cánulas mamarias Luer, estériles,
paq. de 100 uds

IU-147 Sterile *teat cannulas*, 100 units package



IU-112 Cánula tipo oliva

IU-112 Olive type *cannula*



IU-142 Dilatador de tetas
DR NAYLOR

IU-142 DR NAYLOR *teat dilator*



IU-145 Cánulas mamarias, 3,5 cm, paq. 10 uds

IU-145 *Teat cannulas*, 3.5 cm, 10 units package

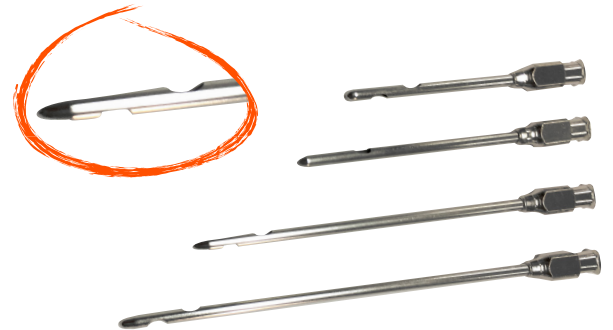

Cánula mamaria cono Luer Lock
Teat cannula, Luer Lock

IU-121 40 mm

IU-121B 80 mm

IU-121A 60 mm

IU-121C 100 mm

REACTIVO PARA TEST DE CALIFORNIA
REAGENT LIQUIT FOR CALIFORNIA TEST



IU-155 Bandeja para test de
mamitis

IU-155 *Paddle for mastitis test*



IU-150 INSERBO de 1 l

IU-150 INSERBO, 1 l



IU-151 BOVI-VET de 1 l

IU-151 BOVI-VET, 1 l



IU-140 Papel indicador mamitis, paq. 25 uds

IU-140 Mastitis indicator *paper*, 25 units Package

Cánulas mamarias / Limpieza de ubres

Teat cannulas / Teat cleaning

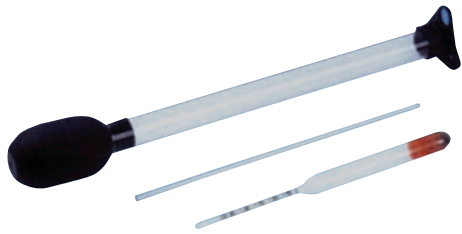

IU-205 Medidor de calostro (calostímetro)

IU-205 Colostrum scale



IT-245 Silla de ordeño con asiento de plástico y cinta de sujeción

IT-245 Milking chair with plastic seat and fastening tape



PA-395 Vendaje para ubres de vacas de 6x5 m

PA-395 6x5 m Teat bandage for cow udders



IU-190

IU-195

IU-197

Botella para desinfección de pezones
Teat disinfectant bottle

IU-190 Sin retorno, 300 ml

IU-195 Con retorno, 300 ml

IU-197 Ambic, acción espuma

IU-190 Without water return, 300 ml

IU-195 With water return, 300 ml

IU-197 Ambic, foaming action

IT-240 Silla de ordeño con asiento de madera y cinta de sujeción

IT-240 Milking chair with wooden seat and fastening tape



IU-200 Botella pulverizadora de pezones con alargo

IU-200 Spray bottle with shaft



IU-160 Toallitas desinfectantes para ubres, cubo de 800 uds

IU-160 Udder disinfectant wipes, bucket of 800 units



IU-138 Grasa para ubres de vacas EUTRA, 500 g

IU-138 EUTRA milking fat, 500 g



IU-136 UDDERMINT 500 ml ungüento para ubres de vacas

IU-136 UDDERMINT 500 ml for cows udders

IU-168 Paños de limpieza para ubres de 32 x 32 cm, paq. 48 uds

IU-168 Udder colth 32 x 32 cm, bag of 48 pcs



IU-170 Rollo de papel para limpieza de ubres

IA-685 Portarrollos de papel de sobremesa y colgante

IA-686 Portarrollos de papel de pie fijo

IU-170 Roll paper for udder cleaning.

IA-685 Table and hanging paper roll carrier

IA-686 Standing paper roll carrier





IA-950 Inyector de 0,50 *IA-950 0.50 injector*



IA-955 Inyector de 0,25 *IA-955 0.25 injector*



IA-960 Inyector universal *IA-960 Universal injector*



IA-962 Inyector universal QUICKLOCK 2000 para vainas y pajuelas

IA-962 QUICKLOCK 2000 universal injector



Pajuelas, paq. de 2.000 uds
Straws, bags of 2,000 units

IA-970 0,25

IA-975 0,50



IA-965 Vainas, paq. de 50 uds

IA-965 Sheaths, 50 units package



IA-980 Catéteres para lavados, paq. de 25 uds

IA-980 Lavage catheter, 25 units package



IA-968 Vainas MINITUBE ranuradas tipo francés, paq. de 50 uds

IA-968A Vainas MINITUBE "sin ranurar", paq. de 50 uds

IA-968 MINITUBE french type sheaths, bag of 50 pcs

IA-968A MINITUBE non split sheaths, bag of 50 pcs



IA-985 Catéteres para lavados de 53,5 cm, paq. de 25 uds

IA-985 Lavage catheter, 53.5 cm, 25 units package



IA-979 Descongelador de pajuelas 12/220 V

IA-979 Straws defroster 12/220 V

IA-978 Cortador para pajuelas

IA-978 Straw cutter





IP-175 Guantes supersensitivos de 90 cm, paq. de 100 uds

IP-175 Supersensitive gloves (90 cm) 100 units box



IP-180 Guantes sensitivos de 90 cm, paq. de 100 uds

IP-180 Sensitive gloves (90 cm) 100 units box



IP-205 Guantes sensitivos naranja de 90 cm, caja de 100 uds

IP-205 90 cm orange sensitive gloves, 100 units box



IP-191 Guantes supersensitivos de protección de hombro y axila, paq. de 50 uds

IP-192 Guantes de protección integral supersensitivos, paq. de 100 uds

IP-191 Supersensitive shoulder and underarm protection gloves, box of 50 units

IP-192 Supersensitive full protection gloves, box of 100 units



Gel lubricante-desinfectante ginecológico
Lubricant gel-gynecologist disinfectant

IA-780 5 l

IA-775 1 l



IO-138 Gel lubricante RAIDEX 1 l

IO-138 Lubrificant gel RAIDEX 1 l



Gel de exploración
exploration gel

IO-130 BOVI-VET 1 l
IO-135 BOVI-VET 500 ml

IO-130 BOVI-VET, 1 l
IO-135 BOVI-VET, 500 ml

Guantes / Campanas Gloves / Bells



Campana suiza de acero color bronce

- IN-450** Diámetro: 105 mm
- IN-455** Diámetro: 125 mm
- IN-460** Diámetro: 145 mm
- IN-465** Diámetro: 165 mm
- IN-470** Diámetro: 185 mm

Swiss steel bell, bronze colour

- IN-450** Diameter: 105 mm
- IN-455** Diameter: 125 mm
- IN-460** Diameter: 145 mm
- IN-465** Diameter: 165 mm
- IN-470** Diameter: 185 mm



Campana suiza con símbolo

- IN-420** Diámetro: 50 mm
- IN-425** Diámetro: 57 mm
- IN-430** Diámetro: 67 mm
- IN-435** Diámetro: 75 mm
- IN-440** Diámetro: 90 mm

Swiss bell with drawing

- IN-420** Diameter: 50 mm
- IN-425** Diameter: 57 mm
- IN-430** Diameter: 67 mm
- IN-435** Diameter: 75 mm
- IN-440** Diameter: 90 mm



Cencerro de acero color bronce

- IN-400** Altura: 60 mm
- IN-405** Altura: 75 mm
- IN-410** Altura: 85 mm
- IN-415** Altura: 100 mm

Steel jangle, bronze colour

- IN-400** Height: 60 mm
- IN-405** Height: 75 mm
- IN-410** Height: 85 mm
- IN-415** Height: 100 mm



Campana de acero color cobre

- IN-475** De 5 x 5
- IN-485** De 12 x 13
- IN-490** De 8 x 9,5

Steel bell, brass colour

- IN-475** 5 x 5
- IN-485** 12 x 13
- IN-490** 8 x 9.5



AGUJAS HIPODÉRMICAS HYPODERMIC NEEDLES

Agujas extrafuertes (caja de 10 unds.)
Extrahard needles (box of 10 units)



Ref.	Medidas- Measures	Medidas Measures	Ref.	Medidas Measures	Medidas Measures
	L/A	A/L		L/A	A/L
AG-800	10 x 10	19G x 3/8"	AG-875	25 x 18	15G x 1"
AG-805	15 x 10	19G x 5/8"	AG-880	25 x 20	14G x 1"
AG-810	15 x 12	18G x 5/8"	AG-885	30 x 14	17G x 1 1/4"
AG-815	15 x 14	17G x 5/8"	AG-890	30 x 16	16G x 1 1/4"
AG-820	15 x 16	16G x 5/8"	AG-895	30 x 18	15G x 1 1/4"
AG-825	15 x 18	15G x 5/8"	AG-900	30 x 20	14G x 1 1/4"
AG-830	15 x 20	14G x 5/8"	AG-905	35 x 16	16G x 1 3/8"
AG-832	15 x 25	13G x 5/8"	AG-910	35 x 18	15G x 1 3/8"
AG-835	20 x 12	18G x 3/4"	AG-915	35 x 20	14G x 1 3/8"
AG-840	20 x 14	17G x 3/4"	AG-920	40 x 16	16G x 1 1/2"
AG-845	20 x 16	16G x 3/4"	AG-925	40 x 18	15G x 1 1/2"
AG-850	20 x 18	15G x 3/4"	AG-930	40 x 20	14G x 1 1/2"
AG-855	20 x 20	14G x 3/4"	AG-940	45 x 20	14G x 1 3/4"
AG-860	25 x 12	18G x 1"	AG-950	50 x 20	14G x 2"
AG-865	25 x 14	17G x 1"	AG-955	55 x 20	14G x 2 3/16"
AG-870	25 x 16	16G x 1"	AG-960	60 x 20	14G x 2 3/8"

LISTA DE CONVERSIÓN - CONVERSION LIST



DIÁMETRO Diameter				LARGO Length			
Ømm	Øcalibre Øgauge	Ømm	Øcalibre Øgauge	mm	pulgadas Inch	mm	pulgadas Inch
0.30	30	1.00/1.10	19	3	1/8	45	1 3/4
0.35	28	1.20/1.30	18	6	1/4	50	2
0.40	27	1.40/1.50	17	8	5/16	55	2 3/16
0.45	26	1.60	16	10	3/8	60	2 3/8
0.50	25	1.80	15	13	1/2	70	3 3/4
0.55	24	2.00/2.10	14	15	5/8	75	3
0.60	23	2.40/2.50	13	20	3/4	80	3 1/4
0.70	22	2.80	12	22	7/8	90	3 1/2
0.80	21	3.00	11	25	1	100	4
0.90	20	3.50	10	30	1 1/4	110	4 1/4
---	---	4.00	8	35	1 3/8	120	4 3/4
---	---	---	---	40	1 1/2	125	5
---	---	---	---	---	---	150	6

ACERO INOX - LUER LOCK STAINLESS STEEL

**Agujas reforzadas
(caja de 12 unds.)
Reinforced needles
(box of 12 units)**



Ref. Ref.	Medidas Measures	Medidas Measures	Ref. Ref.	Medidas Measures	Medidas Measures
	L/A	A/L		L/A	A/L
AG-098	10 x 0,8	21G x 3/8"	AG-150	25 x 15	17G x 1"
AG-100	10 x 10	19G x 3/8"	AG-151	25 x 16	16G x 1"
AG-101	10 x 13	18G x 3/8"	AG-155	25 x 18	15G x 1"
AG-102	10 x 15	17G x 3/8"	AG-160	25 x 20	14G x 1"
AG-102A	13X0,6	23G x 1/2"	AG-161	25 x 25	13G x 1"
AG-103	13 x 10	19G x 1/2"	AG-163	30 x 13	18G x 1 1/4"
AG-104	13 x 13	18G x 1/2"	AG-165	30 x 15	17G x 1 1/4"
AG-104A	13 x 16	16G x 1/2"	AG-166	30 x 16	16G x 1 1/4"
AG-105	15 x 10	19G x 5/8"	AG-170	30 x 18	15G x 1 1/4"
AG-109	15 x 12	18G x 5/8"	AG-175	30 x 20	14G x 1 1/4"
AG-110	15 x 13	18G x 5/8"	AG-177	30 x 25	13G x 1 1/4"
AG-115	15 x 15	17G x 5/8"	AG-180	35 x 15	17G x 1 3/8"
AG-116	15 x 16	16G x 5/8"	AG-185	35 x 18	15G x 1 3/8"
AG-120	15 x 18	15G x 5/8"	AG-190	35 x 20	14G x 1 3/8"
AG-122	15 x 20	14G x 5/8"	AG-193	38 x 18	15G x 1 1/2"
AG-123	15 x 25	13G x 5/8"	AG-195	40 x 15	17G x 1 1/2"
AG-125	20 x 10	19G x 3/4"	AG-196	40 x 16	16G x 1 1/2"
AG-130	20 x 13	18G x 3/4"	AG-200	40 x 18	15G x 1 1/2"
AG-135	20 x 15	17G x 3/4"	AG-205	40 x 20	14G x 1 1/2"
AG-138	20 x 16	16G x 3/4"	AG-208	45 x 20	14G x 1 3/4"
AG-140	20 x 18	15G x 3/4"	AG-210	50 x 20	14G x 2"
AG-145	20 x 20	14G x 3/4"	AG-212	55 x 20	14G x 2 3/16"
AG-146	20 x 25	13G x 3/4"	AG-214	60 x 20	14G x 2 3/8"
AG-147	25 x 10	19G x 1"	AG-216	100 x 0,8	21G x 4"
AG-148	25 x 13	18G x 1"	AG-216A	100 x 20	14G x 4"
	L/A	A/L		L/A	A/L
AG-216Z	4 x 0,6	23G x 1/6"	AG-217B	5 x 0,7	22G x 1/5"
AG-217	4 x 0,7	22G x 1/6"	AG-217C	5 x 0,8	21G x 1/5"
AG-217A	4 x 0,8	21G x 1/6"	AG-217D	6 x 0,9	20G x 1/4"



LISTA DE CONVERSIÓN - CONVERSION LIST

DIÁMETRO Diameter				LARGO Length			
Ømm	Øcalibre Øgauge	Ømm	Øcalibre Øgauge	mm	pulgadas Inch	mm	pulgadas Inch
0.30	30	1.00/1.10	19	3	1/8	45	1 3/4
0.35	28	1.20/1.30	18	6	1/4	50	2
0.40	27	1.40/1.50	17	8	5/16	55	2 3/16
0.45	26	1.60	16	10	3/8	60	2 3/8
0.50	25	1.80	15	13	1/2	70	3 3/4
0.55	24	2.00/2.10	14	15	5/8	75	3
0.60	23	2.40/2.50	13	20	3/4	80	3 1/4
0.70	22	2.80	12	22	7/8	90	3 1/2
0.80	21	3.00	11	25	1	100	4
0.90	20	3.50	10	30	1 1/4	110	4 1/4
---	---	4.00	8	35	1 3/8	120	4 3/4
---	---	---	---	40	1 1/2	125	5
---	---	---	---	---	---	150	6

DISPONIBLE STERIMATIC PARA TODAS LAS JERINGAS HAUPTNER STERIMATIC FOR ALL HAUPTNER SYRINGES AVAILABLE



JG-395 STERIMATIC kit completo, con 5 tapones más adaptador para jeringa de tuberculina

JG-395 STERIMATIC vaccination kit, supplied with 5 caps and adapter for tuberculin syringe



Agujas INSERBO (caja de 12 unds.) INSERBO needles (box of 12 units)



Ref.	Medidas	Medidas	Ref.	Medidas	Medidas
Ref.	Measures	Measures	Ref.	Measures	Measures
AG-400	10 x 10	19G x 3/8"	AG-452	25 x 15	17G x 1"
AG-402	10 x 15	17G x 3/8"	AG-455	25 x 18	15G x 1"
AG-405	15 x 10	19G x 5/8"	AG-460	25 x 20	14G x 1"
AG-410	15 x 13	18G x 5/8"	AG-465	30 x 15	17G x 1 1/4"
AG-415	15 x 15	17G x 5/8"	AG-470	30 x 18	15G x 1 1/4"
AG-420	15 x 18	15G x 5/8"	AG-475	30 x 20	14G x 1 1/4"
AG-422	15 x 20	14G x 5/8"	AG-480	35 x 15	17G x 1 3/8"
AG-425	20 x 10	19G x 3/4"	AG-482	35 x 18	15G x 1 3/8"
AG-430	20 x 13	18G x 3/4"	AG-485	35 x 20	14G x 1 3/8"
AG-435	20 x 15	17G x 3/4"	AG-488	40 x 15	17G x 1 1/2"
AG-440	20 x 18	15G x 3/4"	AG-490	40 x 18	15G x 1 1/2"
AG-445	20 x 20	14G x 3/4"	AG-495	40 x 20	14G x 1 1/2"
AG-450	25 x 13	18G x 1"	AG-500	50 x 20	14G x 2"



AG-218 Aguja de tuberculina STARVET cono Luer Lock, caja de 12 unds

AG-218 STARVET tuberculin needles, Luer Lock

AG-216 Agujas STARVET, 100 x 0,8, caja de 10 unds

AG-216 STARVET needles, 100 x 0.8, box of 10 pcs

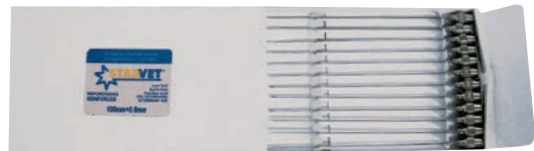

AG-216A Agujas STARVET Luer Lock, 100 x 20

AG-216A STARVET needles, Luer Lock 100 x 20



Agujas desechables STARVET, paq. de 100 unds
STARVET disposable needles, box of 100 pcs

- AG-283** 38 x 2,1
- AG-284** 60 x 2,1
- AG-285** 80 x 2,1

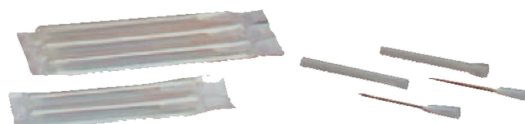

Agujas desechables estériles STARVET, paq. de 100 uds

STARVET *disposable sterile needles,*
box of 100 pcs

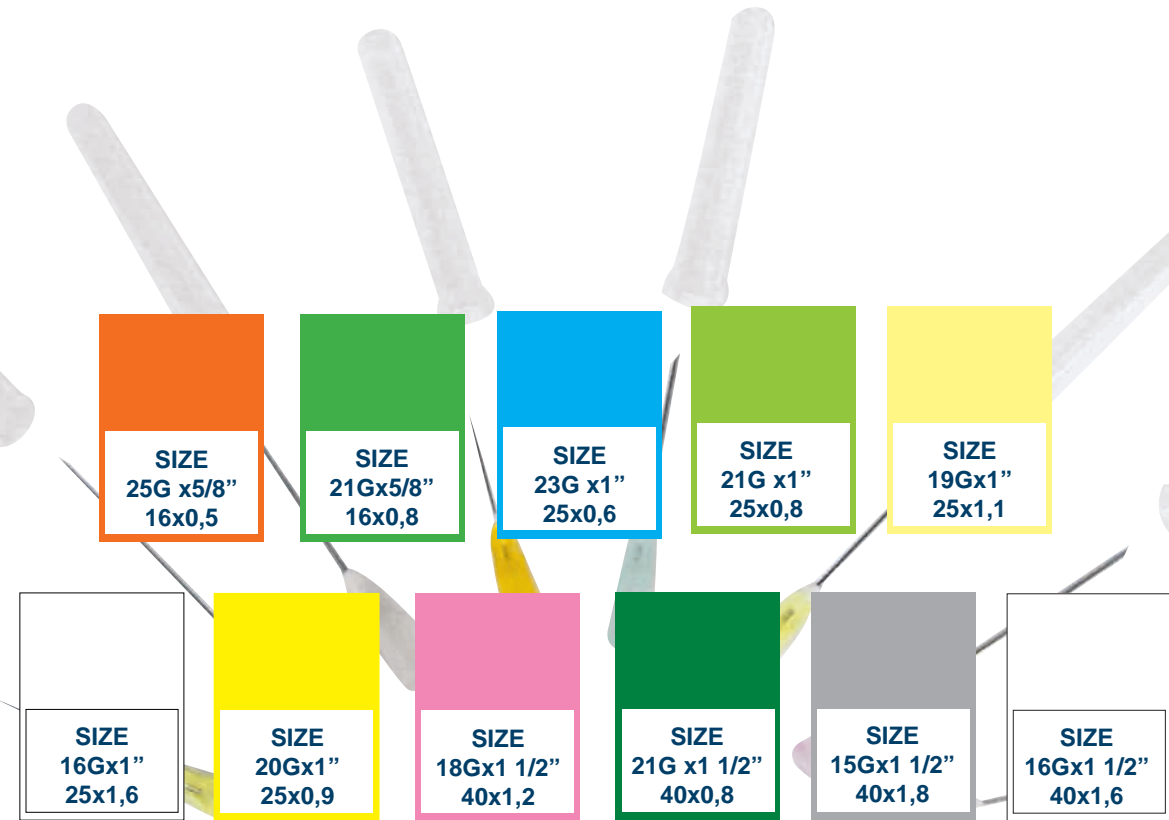

AG-275 16 x 0,5

AG-275A 16 x 0,8

AG-276 25 x 0,6

AG-277 25 x 0,8

AG-278 25 x 0,9

AG-279 25 x 1,1

AG-279C 25 x 1,6

AG-281 40 x 0,8

AG-280 40 x 1,2

AG-281C 40 x 1,6

AG-282 40 x 1,8





AG-223A Agujas desechables
ARTSANA de 16 x 0,5, paquete de 100 unidades

AG-223A ARTSANA disposable needles
16 x 0.5, box of 100 units



JG-100F Jeringas desechables STARVET
de 1 ml con aguja de 16 x 0,5, paquete de 100 unidades

JG-100G Jeringas desechables STARVET de 1 ml sin aguja, paquete de 100 unidades

JG-100F STARVET disposable syringes, 1 ml with needle 16 x 0.5, box of 100 units

JG-100G STARVET disposable syringes, 1 ml without needle, box of 100 units



JG-101 Jeringas desechables ARTSANA
de 1 ml con aguja de 16 x 0,5, paquete de 100 unidades

JG-101 ARTSANA disposable syringes 1 ml with needle 16 x 0.5, box of 100 units



Jeringas desechables STARVET estériles de 2 cuerpos
STARVET sterile **disposable syringes**, 2-component

- JG-100** 2 ml, paquete de 100 unidades
- JG-100A** 5 ml, paquete de 100 unidades
- JG-100B** 10 ml, paquete de 100 unidades
- JG-100C** 20 ml, paquete de 50 unidades

- JG-100** 2 ml, box of 100 units
- JG-100A** 5 ml, box of 100 units
- JG-100B** 10 ml, box of 100 units
- JG-100C** 20 ml, box of 50 units

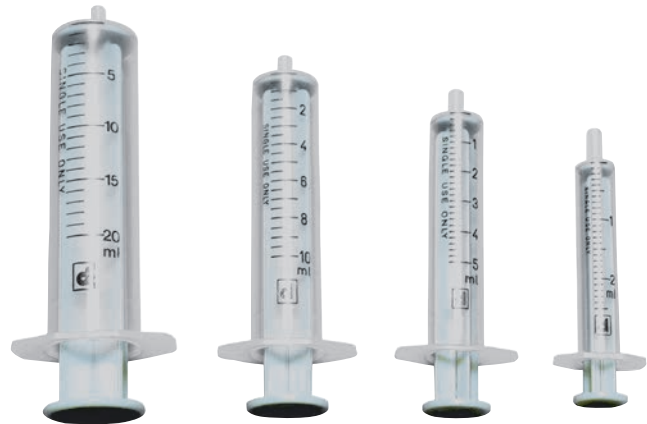



Jeringas desechables STARVET estériles de 3 cuerpos
STARVET sterile disposable syringes, 3-component

JG-100 H 2 ml, paquete de 100 unidades

JG-100 J 5 ml, paquete de 100 unidades

JG-100 K 10 ml, paquete de 100 unidades

JG-100 L 20 ml, paquete de 50 unidades

JG-100H 2 ml box of 100 units

JG-100J 5 ml box of 100 units

JG-100K 10 ml box of 100 units

JG-100L 20 ml box of 50 units



JG-116A Jeringas desechables estériles de 50 ml,
 3 cuerpos, paquete de 25 unidades

JG-116A Disposable syringes 50 ml, 3-component, box of
 25 units



JG-117A Jeringa desechable de 100 ml,
 3 cuerpos, paquete de 25 unidades

JG-117A Disposable syringes 100 ml,
 3-component, box of 25 units



Catéter intravenoso 2 vías con aletas, paquete de 50 unidades *Intravenous injection cannula*, box of 50 pcs

AG-300A 14G, 50 x 2,2 **AG-300C** 20G, 33 x 1,1
AG-300B 18G, 45 x 1,3 **AG-300D** 22G, 25 x 0,9



Equipo de infusión tipo palomilla, paquete de 50 unidades *Butterfly blood collection set*, box of 50 pcs

AG-301 15 x 0,50
AG-302 20 x 0,65



AG-306 Equipo de infusión (gotero) doble vía, cono Luer

AG-306 Luer cone two way, *infusion set*



AG-305 Equipo de infusión (gotero) doble vía, cono Luer Lock

AG-305 Luer Lock cone two way, *infusion set*



AG-307 Equipo de alimentación completo tipo gotero, con bolsa

AG-307 Feeding infusion set with bag

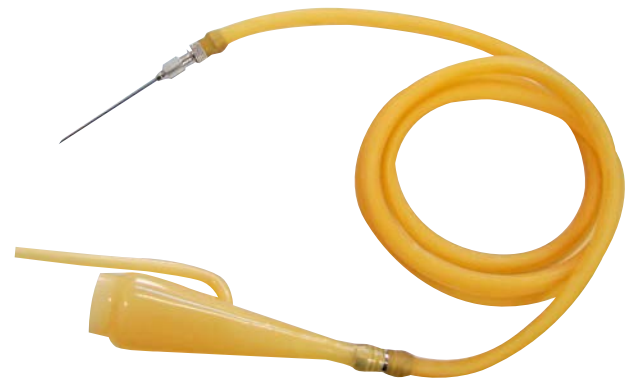

Equipo de infusión reusable cono Luer con aguja *Infusion set reusable Luer cone with needle*

AG-303 50 x 20

Jeringas lisas STARVET

STARVET plain syringes

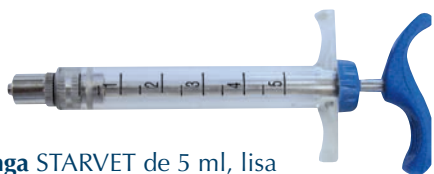

JG-120 Jeringa STARVET de 5 ml, lisa

JG-120 STARVET plain syringe, 5 ml



JG-121 Jeringa STARVET de 10 ml, lisa

JG-121 STARVET plain syringe, 10 ml



JG-122 Jeringa STARVET de 20 ml, lisa

JG-122 STARVET plain syringe, 20 ml



JG-123 Jeringa STARVET de 30 ml, lisa

JG-123 STARVET plain syringe, 30 ml



JG-124 Jeringa STARVET de 50 ml, lisa

JG-124 STARVET plain syringe, 50 ml



JG-129 Jeringa STARVET de 100 ml, lisa

JG-129 STARVET plain syringe, 100 ml

Jeringas graduables STARVET

STARVET adjustable syringes



JG-125 Jeringa STARVET de 10 ml, graduable

JG-125 STARVET adjustable syringe, 10 ml



JG-126 Jeringa STARVET de 20 ml, graduable

JG-126 STARVET adjustable syringe, 20 ml



JG-127 Jeringa STARVET de 30 ml graduable

JG-127 STARVET adjustable syringe, 30 ml



JG-128 Jeringa STARVET de 50 ml, graduable

JG-128 STARVET adjustable syringe, 50 ml



JG-121A Jeringa STARVET de 1 m a distancia, de 10 ml
JG-122A Jeringa STARVET de 1 m a distancia, de 20 ml

JG-121A STARVET syringe at 1 m distance, 10 ml
JG-122A STARVET syringe at 1 m distance, 20 ml



JERINGAS VACUNADORAS VACCINATION SYRINGES



Jeringa vacunadora STARVET con tubo y aguja

*STARVET vaccination syringe with feeding
tube and needle*

JG-901 1 ml (0,05 a/to 1 ml)

JG-902 2 ml (0,1 a/to 2 ml)

JG-905 5 ml (0,5 a/to 5 ml)



Jeringa vacunadora STARVET con portavascos

*STARVET vaccination syringe with vial
holder*

JG-901A 1 ml (0,05 a/to 1 ml)

JG-902A 2 ml (0,1 a/to 2 ml)

JG-905A 5 ml (0,5 a/to 5 ml)

DE 1, 2 Y 5 ML
1, 2 and 5 ml



Jeringa vacunadora STARVET con botella

STARVET vaccination syringe with bottle

JG-901B 1 ml (de 0,05 a/to 1 ml)

JG-902B 2 ml (de 0,1 a/to 2 ml)

JG-905B 5 ml (de 0,5 a/to 5 ml)

Jeringa vacunadora STARVET con contador electrónico digital

STARVET vaccination syringe with electronic digital counter

JG-901D 1 ml (0,05 a/to 1 ml)

JG-902C 2 ml (0,1 a/to 2 ml)

JG-905C 5 ml (0,5 a/to 5 ml)



Alargos / Extension



- JG-985** Alargo de 35cm para jeringa vacunadora STARVET
- JG-986** Alargo de 50cm para jeringa vacunadora STARVET
- JG-987** Alargo-bastón STARVET de 1mt

- JG-985 35cm Extension for STARVET vaccination syringe*
- JG-986 50cm Extension for STARVET vaccination syringe*
- JG-987 STARVET 1m syringe extension*

- JG-927AA** adaptador hembra portafrasco para frasco de 250-500 ml. 33 mm
- JG-927AB** adaptador hembra portafrasco para frasco de 100 ml. 20 mm

- JG-927AA Female bottle-holder adapter for 250-500 ml 33 mm bottle*
- JG-927AB Female bottle-holder adapter for 100 ml 20 mm bottle*

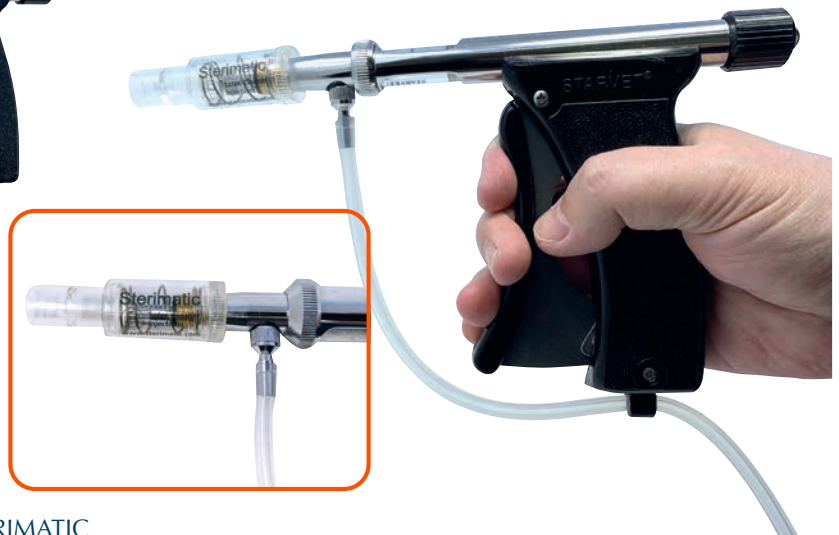

- JG-935A** Racord adaptador STARVET para STERIMATIC
- JG-935B** Tubo de plastico con muelle STERIMATIC para vacunadoras STARVET
- JG-935C** Tapón STERIMATIC para desinfección agujas STARVET, paq. de 5 u
- JG-935D** Kit completo STERIMATIC para jeringa STARVET con 5 tapones mas adaptador

- JG-935A STARVET adapter fitting for STERIMATIC*
- JG-935B STERIMATIC plastic tube with spring for STARVET vaccinators*
- JG-935C STERIMATIC cap for STARVET needle disinfection, pack of 5 units*
- JG-935D STERIMATIC complete kit for STARVET vaccinators with 5 caps plus adapter disinfection, pack of 5 units*



- JG-999G** Protector Fishguard grande de 50mm STARVET
- JG-999F** Protector Fishguard mediano de 25mm STARVET
- JG-999E** Protector Fishguard pequeño de 15mm STARVET

- JG-999G Large 50 mm STARVET Fishguard*
- JG-999F Medium 25 mm STARVET Fishguard*
- JG-999E Small 15 mm STARVET Fishguard*



ACCESORIOS VACUNADORA

VACCINATOR ACCESSORIES



JG-990A Depósito completo de 3 l, transparente para vacunadoras STARVET

JG-990A Complete transparent container, 3 l STARVET vaccinators



JG-990 Depósito completo de 3 l para vacunadoras STARVET

JG-990 Complete container, 3 l STARVET vaccinators



Tapones de recambio completos
Complete replacement caps



JG-990AA Depósito completo de 3 l, plano transparente vacunadoras STARVET

JG-990AB Depósito completo de 3 l, plano transparente vacunadoras STARVET, sin tubo/entrada de aire

JG-990AA 3 l complete container, flat transparent STARVET vaccinators

JG-990AB 3 l complete container, flat transparent STARVET vaccinators, without tube/air inlet

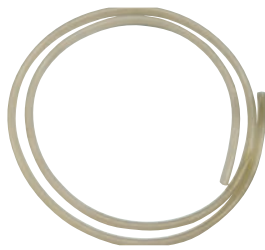

JG-980 Tubo de silicona de 1 m

JG-980 Silicone tube, 1 m



Agujas de aspiración para vacunadora STARVET
Aspiration needle for STARVET vaccinators

JG-975 Larga

JG-975 Long

JG-975A Larga doble

JG-975A Long double

JG-976 Corta

JG-976 Short

JG-999A Cinturón porta jeringas vacunadoras STARVET 1-2ml

JG-999B Cinturón porta jeringas vacunadoras STARVET 5ml

JG-999A STARVET 1-2ml vaccinator syringe holder belt

JG-999B STARVET 5ml vaccinator syringe holder belt

JG-990B Juego de trinchas para depósito STARVET de 3 l

JG-990B Container holding straps set, 3 l



Botella con tapón para jeringa STARVET
Complete bottle with cap for STARVET syringe

JG-996 1 l, sin cinturón / without belt

JG-995B 100 ml



JG-997 Botella completa con cinturón STARVET, 1 l

JG-997 Complete STARVET bottle with belt 1 L



JG-996A Cinturón portabotella STARVET, 1 l (sin botella)

JG-996A STARVET belt bottle carrier 1 l (without bottle)



DESPIECE JERINGA VACUNADORA STARVET

5 ML, 2 ML Y 1ML

STARVET VACCINATOR SPARE PARTS 5 ML, 2 ML AND 1 ML



5 ml

2 ml

1 ml

N° 1	JG-926	JG-925	JG-924
N° 2	JG-920	JG-915	JG-914
N° 3	JG-931	JG-930	JG-929
N° 4	JG-952	JG-952	JG-952
N° 6	JG-957	JG-957	JG-957
N° 7	JG-956	JG-956	JG-956
N° 8	JG-955	JG-955	JG-955
N° 10	JG-935	JG-935	JG-935
N° 12	JG-936	JG-936	JG-936
N° 13	JG-941	JG-940	JG-939
N° 14	JG-960	JG-960	JG-960

Vacunadoras STARVET a baterías

5 ml, 2 ml y 1ml

STARVET battery vaccinators

5 ml, 2ml and 1 ml



Pantalla con indicador de nivel de batería, contador total y parcial de número de inyecciones

Display with battery level indicator, total and partial counter of the number of injections



También con portafrascos

Also with vial holder

- JG-910 1 ml con tubo y aguja
- JG-910A 1 ml con portafrascos
- JG-911 2 ml con tubo y aguja
- JG-911A 2 ml con portafrascos
- JG-912 5 ml con tubo y aguja
- JG-912A 5 ml con portafrascos

- JG-910 1 ml with feeding tube and needle
- JG-910A 1 ml with vial holder
- JG-911 2 ml with feeding tube and needle
- JG-911A 2 ml with vial holder
- JG-912 5 ml with feeding tube and needle
- JG-912A 5 ml with vial holder

Unas 3 horas de trabajo continuo en cada carga de batería

About 3 hours of continuous work on each battery charge

Compatible con todos los recambios y accesorios disponibles para la vacunadora STARVET manual

Compatible with all the spare parts and accessories available for the manual STARVET vaccinator



JG-913 Batería de recambio

JG-913 Replacement battery

JG-994C Spray súper lubricante de grasa al Litio de 200 ml.

JG-994C 200 ml super Lithium grease lubricant spray





JN-100 Jeringa neumática de 2 ml con tubo de aspiración

JN-100 Pneumatic syringe with feeding tube (2 ml)

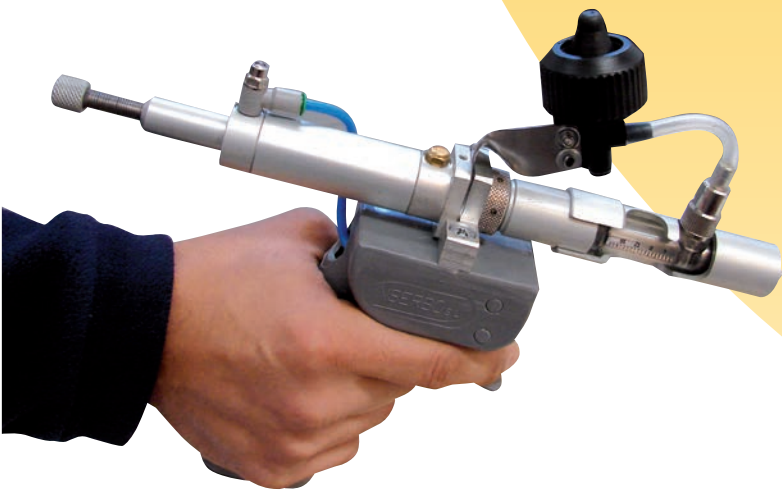

JN-110 Jeringa neumática de 2 ml con portafrascos

JN-110 Pneumatic syringe with vial holder (2 ml)

JN-150 Jeringa neumática de 5 ml con tubo de aspiración

JN-150 Pneumatic syringe with feeding tube (5 ml)



Jeringas neumáticas

Pneumatic syringes

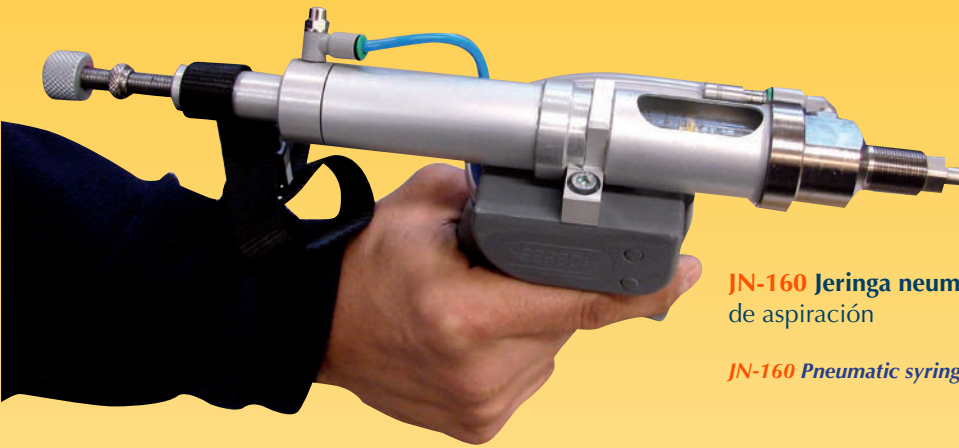

JN-160 Jeringa neumática de 5/10 ml con tubo de aspiración

JN-160 Pneumatic syringe with feeding tube (5/10 ml)



JN-170 Jeringa neumática de 30 ml con tubo de aspiración

JN-170 Pneumatic syringe with feeding tube (30 ml)

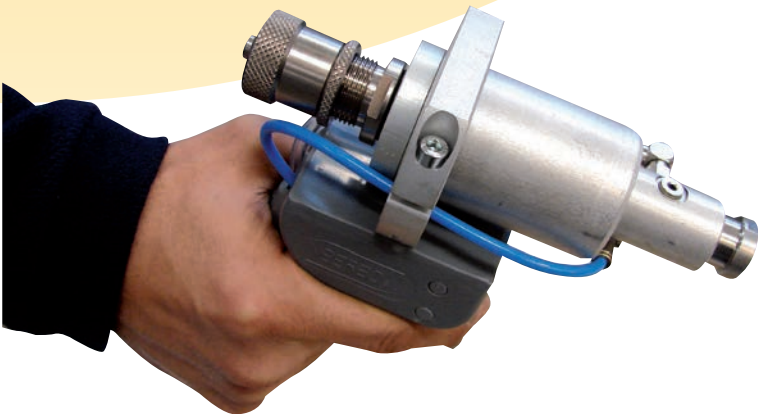

JN-185 Jeringa neumática "sin aguja" de 0,2 ml
JN-190 Jeringa neumática "sin aguja" de 0,1 ml

JN-185 Pneumatic syringe without needle of 0.2 ml
JN-190 Pneumatic syringe without needle of 0.1 ml

JN-140 Jeringa neumática de 2+2 ml con portafascos

JN-130 Jeringa neumática de 2+2 ml con tubo de aspiración

JN-140 Pneumatic syringe with vial holder (2+2 ml)

JN-130 Pneumatic syringe with feeding tube (2+2 ml)

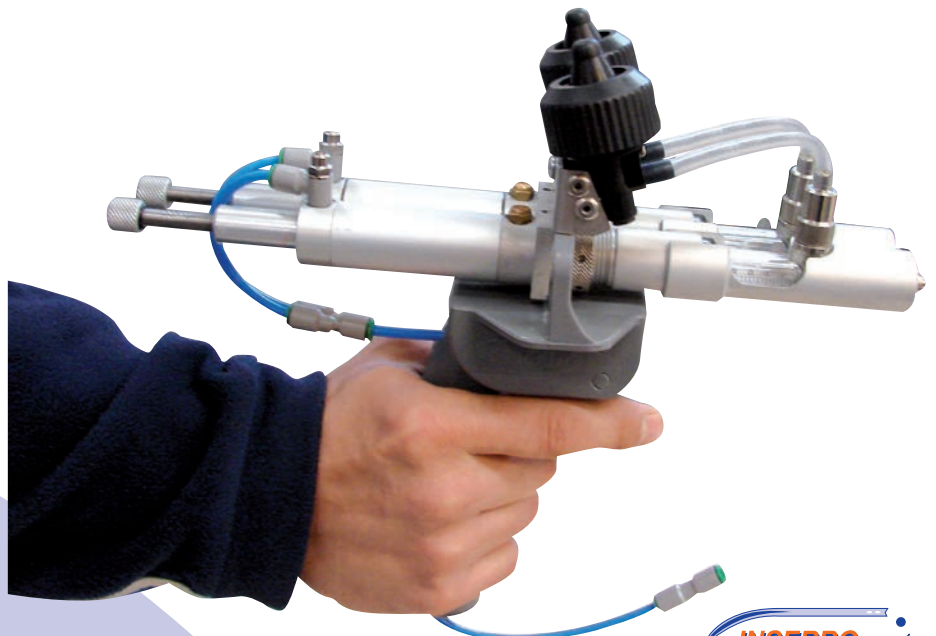



Alargo flexible / Flexible extension

JN-200 10 cm

JN-205 20 cm

JN-210 35 cm

JN-212 50 cm

JN-215 70 cm

JN-220 100 cm

JN-225 120 cm

JN-230 150 cm



Alargo rígido / Rigid extension

JN-235 10 cm

JN-240 20 cm

JN-245 40 cm

JN-250 70 cm

JN-255 100 cm

JN-260 120 cm

JN-265 150 cm



JN-295 Multiplicador de presión para los tanques

JN-295 Pressure multiplier for tanks



JN-310 Portafrascos para las jeringas neumáticas

JN-310 Bottle holder for pneumatic syringe

JN-285 Carro transporte con 2 tanques de 10 l para 2 jeringas

JN-285 Trolley with 2 tanks of 10 l for two syringes



Alargos / Carros / Mochilas

Extensions / Trolleys / Tanks



JN-290 Carro tratamiento lechones
con 2 tanques para jeringas neumáticas

JN-290 Piglets treatment trolley with 2 tanks
for pneumatic syringes



JN-280 Mochila tanque de aire de 10 l

JN-280 Air tank backpack (10 l)





Jeringas vacunadoras SOCOREX con aguja y tubo de goma
SOCOREX vaccination syringes with feeding tube and needle

- JG-408** 0,3 ml
- JG-409** 0,5 ml
- JG-410** 1 ml
- JG-415** 2 ml
- JG-420** 5 ml
- JG-421** 10 ml

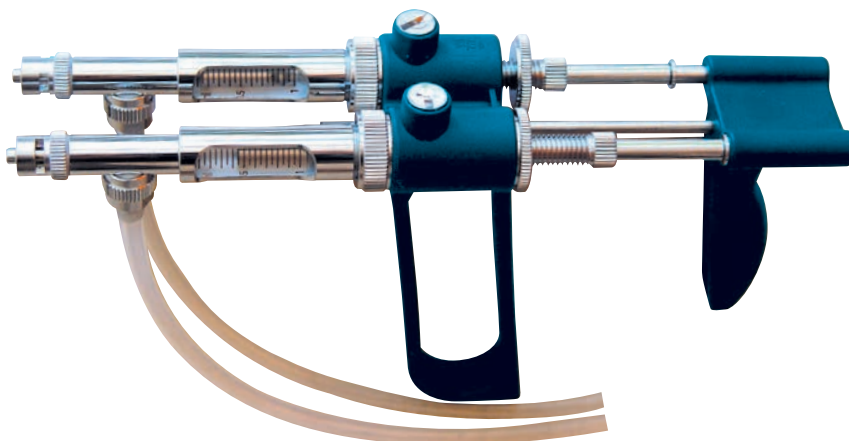
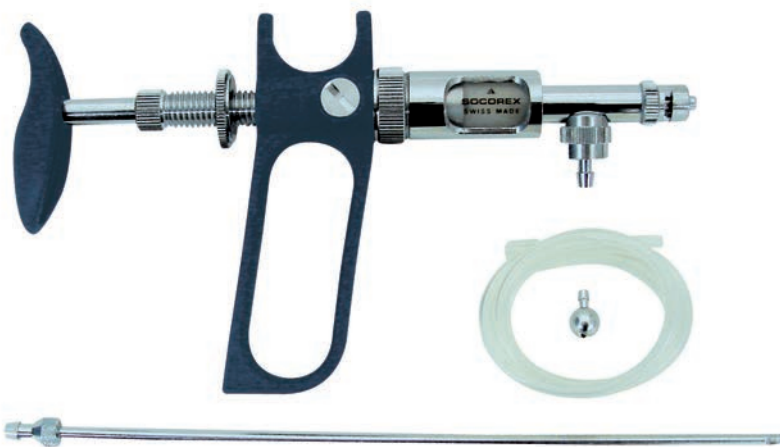

Jeringas vacunadoras doble SOCOREX
con tubo de goma
SOCOREX twin syringe with feeding tube

- JG-422** 0,5 + 0,5 ml
- JG-423** 1+1 ml
- JG-424** 2+2 ml
- JG-424B** 5+5 ml

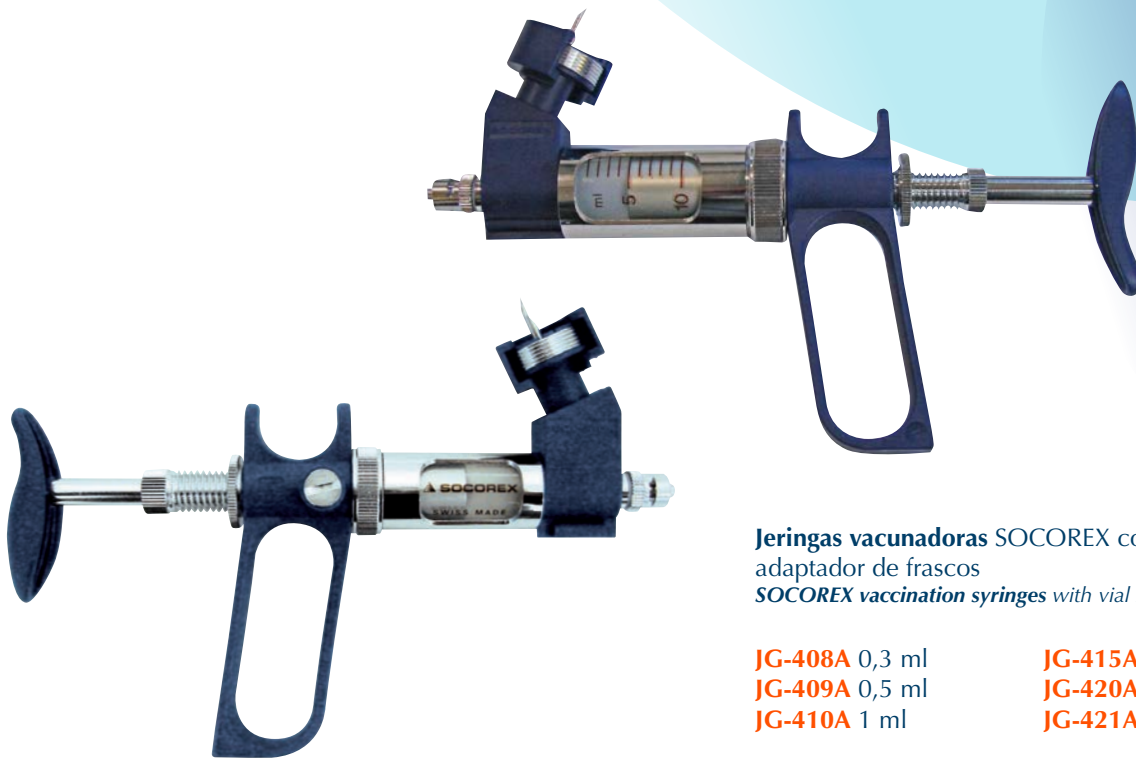

Jeringas vacunadoras SOCOREX con adaptador de frascos
SOCOREX vaccination syringes with vial holder

- | | |
|-----------------------|----------------------|
| JG-408A 0,3 ml | JG-415A 2 ml |
| JG-409A 0,5 ml | JG-420A 5 ml |
| JG-410A 1 ml | JG-421A 10 ml |



Alargo para jeringa SOCOREX
SOCOREX extension

- | |
|----------------------|
| JG-434 35 cm |
| JG-434A 20 cm |



JG-424A Adaptador para jeringa doble SOCOREX para uso de 1 aguja

JG-424A SOCOREX twin syringe adaptor for 1 needle usage



Agujas de aspiración SOCOREX
SOCOREX aspiration needles

- | | |
|----------------------|----------------------|
| JG-438 Larga | JG-438 Long |
| JG-438A Corta | JG-438A Short |



JG-438B Aguja aspiración plástico SOCOREX con filtro, paq. 6 uds

JG-438B SOCOREX plastic aspiration needle with filter, bag of 6 pcs



JG-435 Adaptador SOCOREX para frascos, de 2 a 100 ml

JG-435A Aguja adaptador SOCOREX para frascos, de 1 a 2 ml

JG-440 Botella SOCOREX, 60 ml

JG-436 Cono con rosca doble para botella

JG-435 SOCOREX vial holder from 2 to 100 ml

JG-435A SOCOREX vial holder needle

JG-440 SOCOREX bottle, 60 ml

JG-436 Bottle cone adaptor, thread

Jeringa vacunadora FIJA SOCOREX con tubo y aguja
SOCOREX fixed vaccination syringe with feeding tube and needle

- | | |
|-----------------------|-----------------------|
| JG-424E 0,2ml | JG-424G 0,5 ml |
| JG-424F 0,3 ml | JG-424H 1 ml |

Jeringa vacunadora fija SOCOREX con portafrascos
SOCOREX fixed vaccination syringe with vial holder

- | | |
|------------------------|------------------------|
| JG-424EE 0,2ml | JG-424GG 0,5 ml |
| JG-424FF 0,3 ml | JG-424HH 1 ml |

MODELOS DE DOSIS FIJA
FIXED DOSE MODELS



JG-429L Bote de lubricante Premium SOCOREX, 70 ml

JG-429L SOCOREX Premium lubricant gel, 70 ml



DESPIECE JERINGA SYRINGE PART LIST

JERINGA TUBO Y AGUJA

FEEDING TUBE SYRINGE

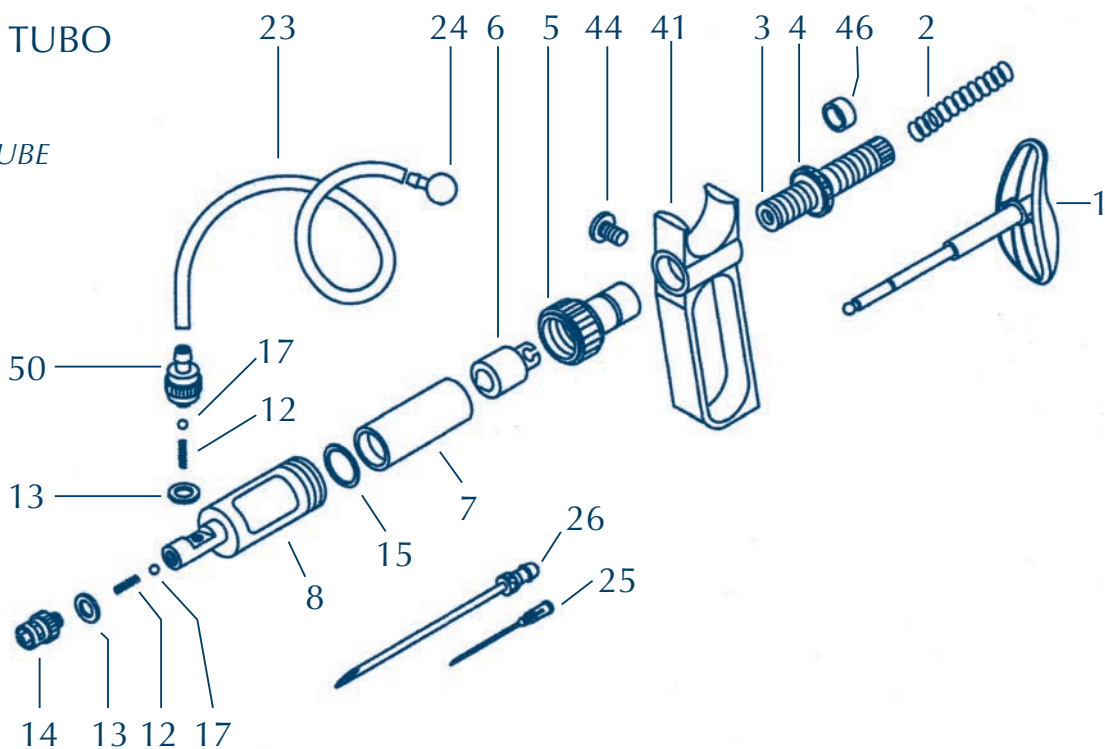

- 1. Varilla de pistón
- 2. Muelle
- 3. Casquillo
- 4. Tuerca
- 5. Tapa
- 6. Pistón
- 7. Cilindro
- 8. Envoltura
- 12. Muelle
- 13. Arandela

- 1. Piston rod
- 2. Spring
- 3. Socket
- 4. Front nut
- 5. Cap
- 6. Piston
- 7. Barrel
- 8. Casing
- 12. Spring
- 13. Washer

- 14. Válvula de cono
- 15. Arandela del cilindro
- 17. Esfera de válvula
- 23. Tubo
- 24. Sumidero (excepto el modelo de 20 ml)
- 25. Cánula de ventilación
- 26. Aguja de alimentación
- 41. Empuñadura
- 44. Tornillo
- 46. Camisa de PTFE

- 14. Nozzle valve
- 15. Washer
- 17. Valve ball
- 23. Tubing
- 24. Sinker
- 25. Vent cannula
- 26. Feed needle
- 41. Two ring handle
- 44. Screw
- 46. Sleeve

- 48. Pieza de mano
- 50. Válvula de entrada
- 51. Tubo de conexión
- 52. Aguja de entrada
- 53. Cuerpo del portavial (2 piezas)
- 54. Anillo, portavial
- 55. Bloqueo, portavial
- 56. Arandela de caucho

- 48. Hand piece
- 50. Intake valve
- 51. Connecting tube
- 52. Intake needle
- 53. Vial holder
- 54. Ring, vial holder
- 55. Lock, vial holder
- 56. Rubber washer

JERINGA CON PORTAFRASCOS

VIAL HOLDER
SYRINGE

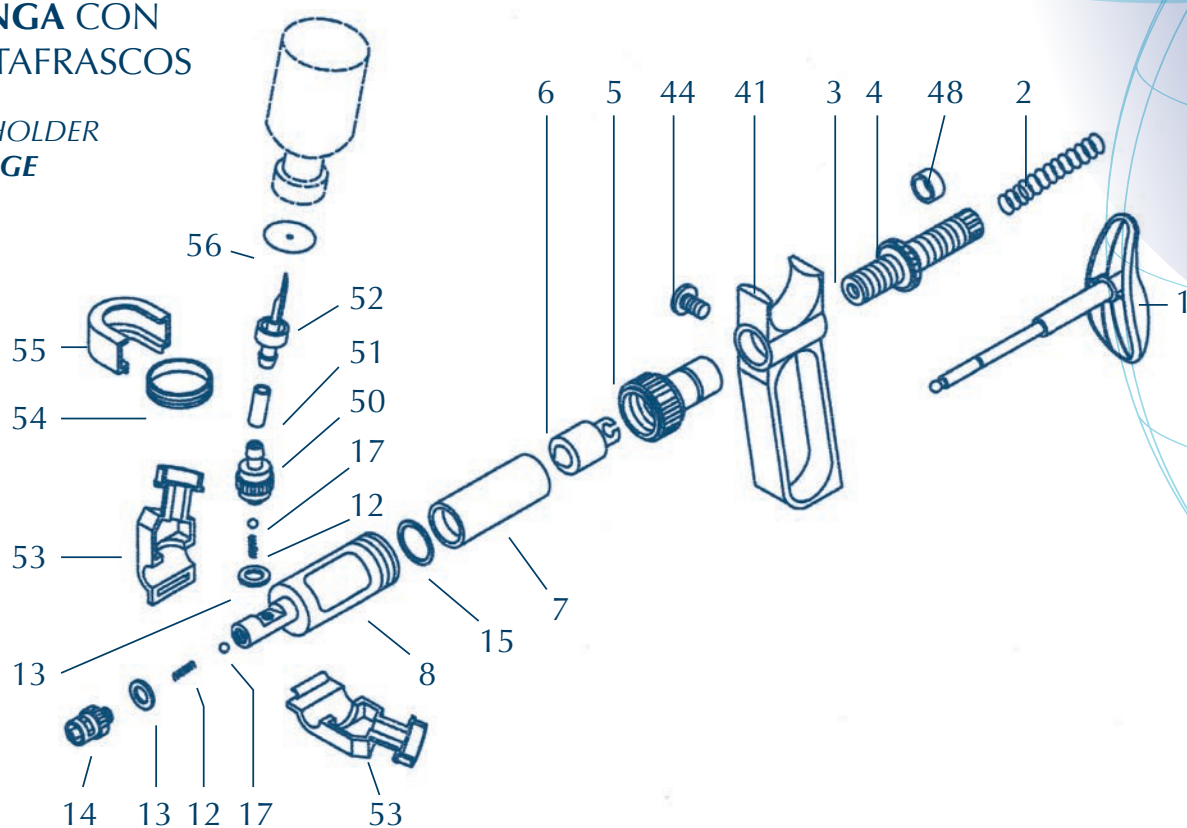

JERINGA DOBLE

TWIN SYRINGE

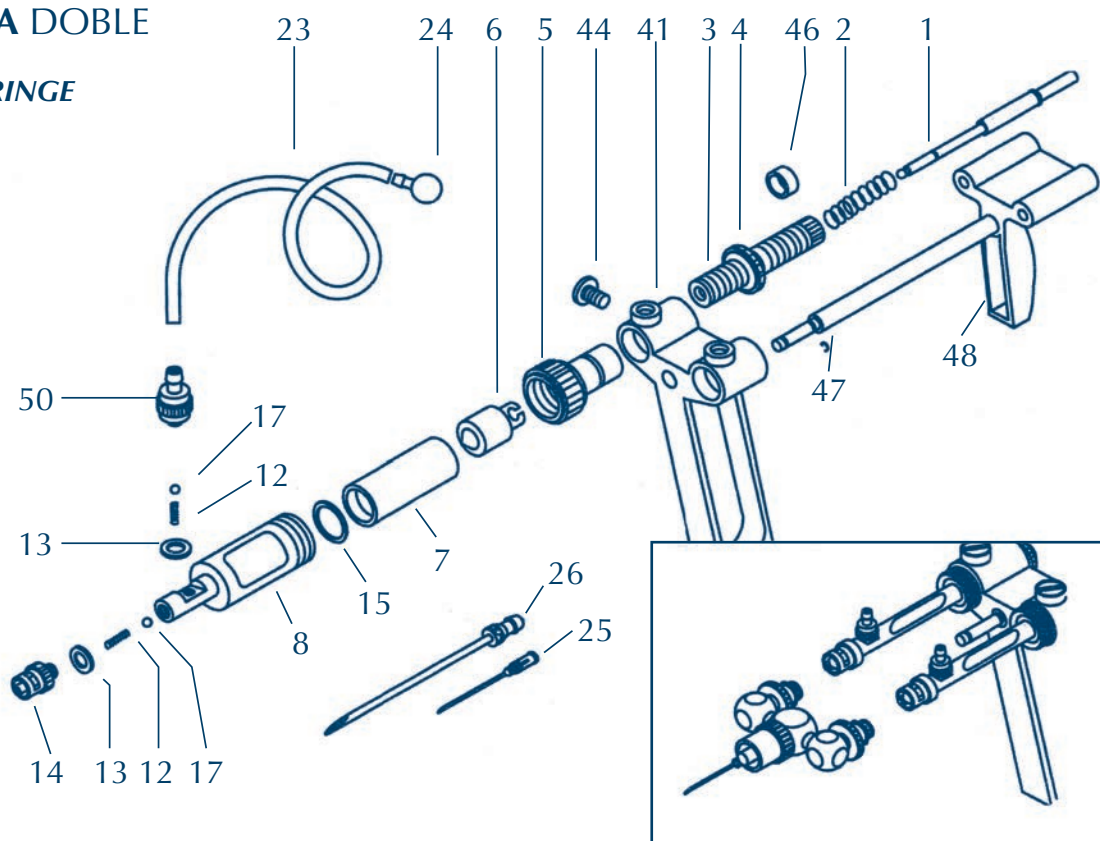

DESPIECE JERINGA HAUPTNER

HAUPTNER SYRINGE SPARES

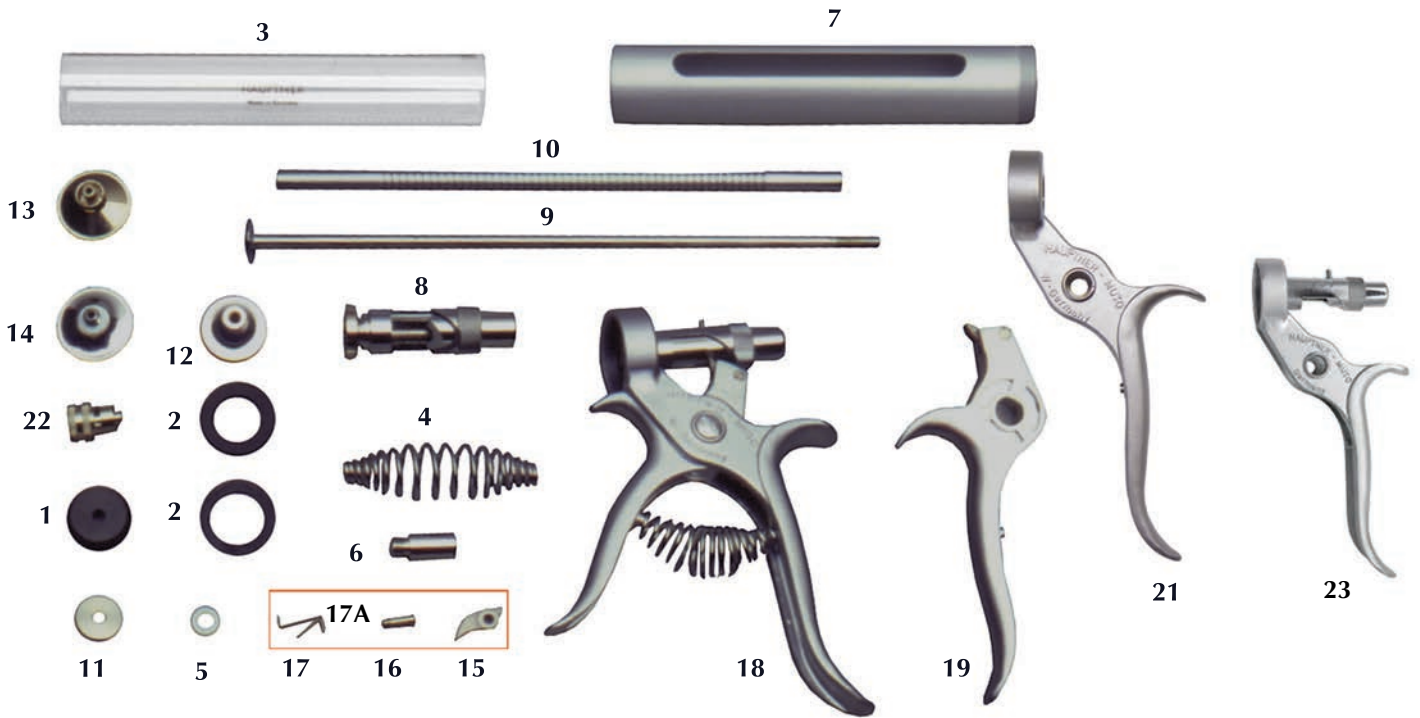

	50 ml	30 ml	25 ml	10 ml
N° 1	JG-195	JG-195	JG-194	JG-193
N° 2	JG-199	JG-199	JG-198	JG-196
N° 3	JG-230	JG-225	JG-220	JG-219
N° 4	JG-235	JG-235	JG-235	JG-235
N° 5	JG-240	JG-240	JG-240	JG-240
N° 6	JG-245	JG-245	JG-245	JG-245
N° 7	JG-250	JG-255	JG-260	JG-261
N° 8	JG-265	JG-265	JG-270	JG-271
N° 9	JG-290	JG-295	JG-300	JG-301
N° 10	JG-305	JG-310	JG-305	JG-311
N° 11	JG-315	JG-315	JG-320	JG-312
N° 12	JG-325	JG-325	JG-325	JG-325
N° 13	JG-330	JG-330	JG-336	----
N° 14	JG-331	JG-331	JG-335	JG-337
N° 15	JG-340	JG-340	JG-340	JG-340
N° 16	JG-345	JG-345	JG-345	JG-345
N° 17	JG-350	JG-350	JG-350	JG-350
N° 17A	JG-339	JG-339	JG-339	JG-339
N° 18	JG-355	JG-355	JG-363	----
N° 19	JG-360	JG-360	JG-360	JG-360
N° 20	JG-361	JG-361	JG-361	JG-361
N° 21	JG-366	JG-366	----	----
N° 22	JG-370	JG-370	JG-370	JG-370
N° 23	JG-365	JG-365	JG-362	----

Jeringas revólver

Gun syringes



JG-175 Jeringa revólver HAAPTNER
de 10 ml (0,25 a 1 ml)

JG-175 HAAPTNER *gun syringe*, 10 ml
(0.25 to 1 ml)

JG-180 Jeringa revólver HAAPTNER de 25 ml (0,5 a 2,5 ml)

JG-180 HAAPTNER *gun syringe*, 25 ml (0.5 to 2.5 ml)



JG-185 Jeringa revólver HAAPTNER de 30 ml
(de 1 a 5 ml)

JG-185 HAAPTNER *gun syringe*, 30 ml (1 to 5 ml)



JG-190 Jeringa revólver HAAPTNER
de 50 ml (de 1 a 5 ml)

JG-190 HAAPTNER *gun syringe*, 50 ml (1
to 5 ml)





JG-372 Racord HAUPtNER Luer-Lock para adaptar tubos de silicona

*JG-372 HAUPtNER Luer-Lock **part** to adapt silicone tubes*



JG-371 Cono HAUPtNER Luer-Lock para adaptar tubos de silicona

*JG-371 HAUPtNER Luer-Lock **hub** to adapt silicone tubes*



JG-371A Cono HAUPtNER rosca para adaptar tubos de silicona

*JG-371A HAUPtNER **thread** to adapt silicone tubes*



Empaque rosca HAUPtNER
*HAUPtNER **needle mount** with thread*

JG-331 30 ml y 50 ml
JG-335 25 ml



JG-381B Cono rosca doble para alargadera HAUPtNER

*JG-381B HAUPtNER **double thread** for extension syringe*



JG-370 Rácord HAUPtNER Luer Lock

*JG-370 HAUPtNER Luer Lock **fitting***



JG-381A Junta tórica para alargadera HAUPtNER

*JG-381A HAUPtNER **O-ring** for extension syringe*



JG-380 Alargador bastón de 90 cm HAUPtNER

*JG-380 HAUPtNER 90 CM **syringue extension***



Alargadera para jeringa HAUPtNER
*HAUPtNER **syringe extension***

JG-381 35 cm
JG-382 25 cm
JG-382A 50 cm



JG-390 Alargo vacunador para acoplar a jeringas, STARVET-NEEDLE

JG-390 STARVET-NEEDLE, vaccinator extension to adapt to syringe



JG-394 Kit completo Sterimatic para jeringa HAUPtNER con 5 tapones + adaptador, de 50 ml

*JG-394 HAUPtNER **Sterimatic set** for syringe with 5 caps + adaptor, 50 ml*



JG-177 Jeringa vacunadora HAUPtNER con portafrascos

*JG-177 HAUPtNER **vaccination syringe** with vial holder*

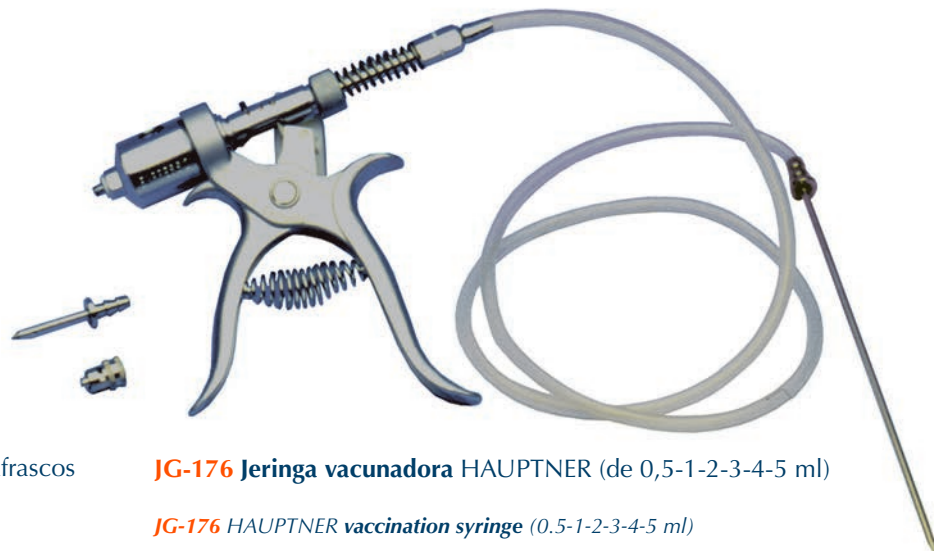

JG-176 Jeringa vacunadora HAUPtNER (de 0,5-1-2-3-4-5 ml)

*JG-176 HAUPtNER **vaccination syringe** (0.5-1-2-3-4-5 ml)*

DESPIECE JERINGA VACUNADORA HAUPTNER
HAUPTNER VACCINATION SPARES

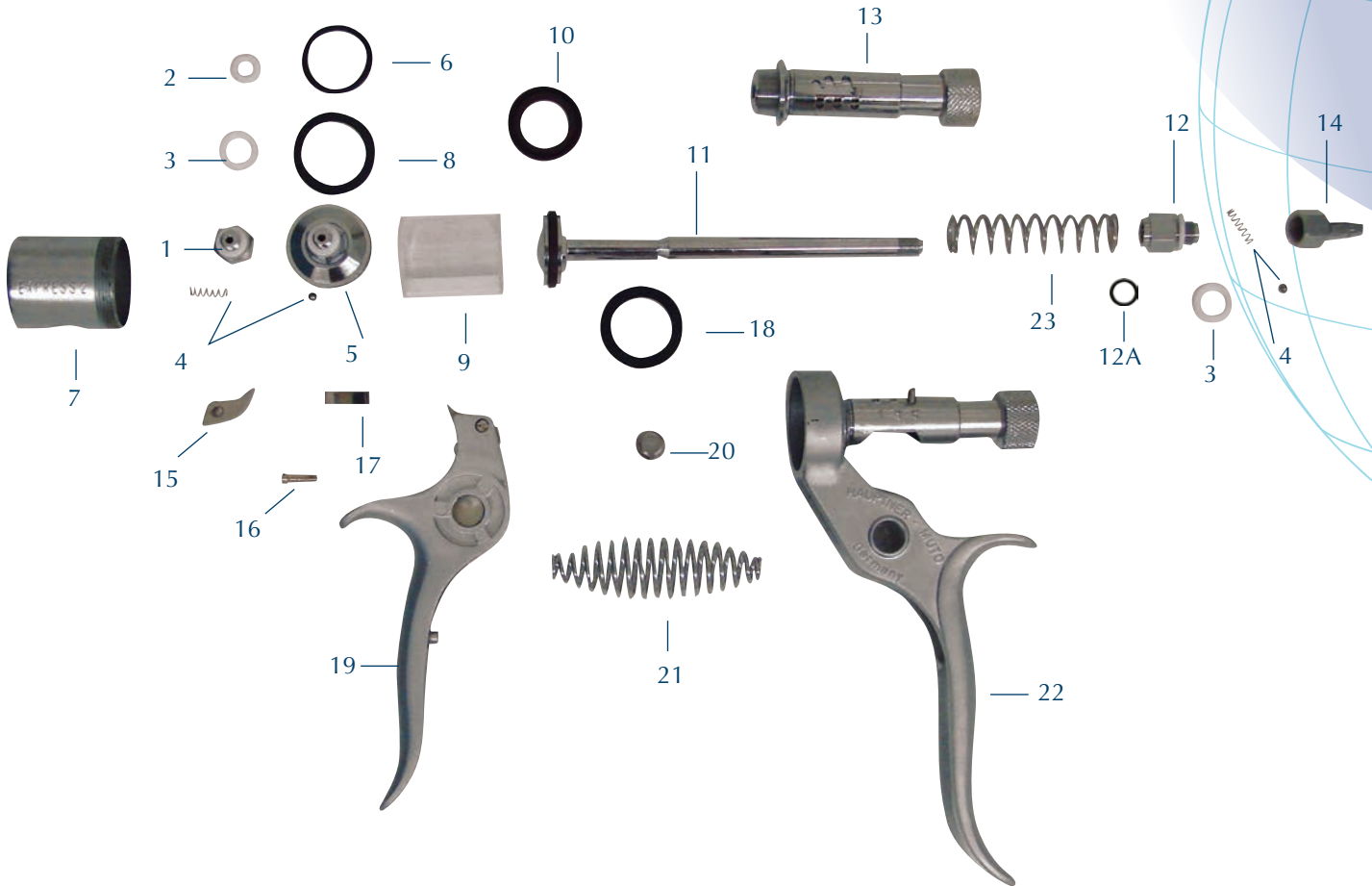

N° 1	JG-386	N° 12A	JG-386J
N° 2	JG-386B	N° 13	JG-385
N° 3	JG-386E	N° 14	JG-386GG
N° 4	JG-375	N° 12 + N° 14	JG-386G
N° 5	JG-386A	N° 15	JG-340
N° 6	JG-386C	N° 16	JG-345
N° 7	JG-386F	N° 17	JG-350
N° 8	JG-386D	N° 18	JG-386DD
N° 8 + N° 18	JG-386H	N° 19	JG-360
N° 9	JG-218	N° 20	JG-245
N° 10	JG-387	N° 21	JG-235
N° 11	JG-384	N° 22	JG-367
N° 12	----	N° 23	JG-386I

N° 2+ N° 3+ N° 6+ N° 8+ N° 10+ N° 12A+ N° 18	JG-387A
--	---------



JG-803 Jeringa revólver ROUX con alargó, 50 ml

JG-803 ROUX gun syringe with extension, 50 ml

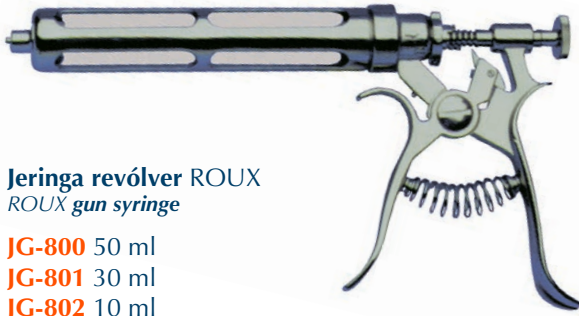

Jeringa revólver ROUX
ROUX gun syringe

JG-800 50 ml

JG-801 30 ml

JG-802 10 ml



Jeringa metálica
Metal syringe

JG-785 10 ml

JG-790 20 ml

JG-795 50 ml

JG-795A 100 ml



JG-150 Jeringa revólver de 50 ml, mango metálico

JG-150 Gun syringe, 50 ml, metal handle



JG-145 Jeringa revólver, 50 ml

JG-145 Gun syringe, 50 ml

GROTEERMAN®



JG-900 Jeringa intradérmica GROTEERMAN

JG-895 Jeringa intradérmica GROTEERMAN con cabezal de 3 salidas

JG-900 GROTEERMAN Intra dermal syringe

JG-895 GROTEERMAN Intra dermal syringe with 3-outlet head



JG-900A Jeringa intradérmica automática GROTEERMAN

JG-900B Jeringa intradérmica automática GROTEERMAN con cabezal de 3 salidas

JG-900A GROTEERMAN Intra dermal automatic syringe

JG-900B GROTEERMAN Intra dermal automatic syringe with 3-outlet head



JG-890 Cabezal de 3 salidas para jeringas GROTEERMAN

JG-890 3-exhaust head for GROTEERMAN syringes

Jeringas revólver y vacunadoras

Gun syringes / Vaccinators



Jeringa vacunadora con aguja y tubo de aspiración
Vaccination syringe with feeding tube and needle

JG-462 1 ml
JG-460 2 ml
JG-458 5 ml



Jeringa vacunadora con portafrascos
Vaccination syringe with vial holder

JG-463 1 ml
JG-461 2 ml
JG-459 5 ml



JG-465 Jeringa vacunadora de 5 ml, con aguja y tubo (Eco)
JG-466 Jeringa vacunadora de 5 ml, con portafrasco (Eco)

JG-465 Vaccination syringe 5 ml, with feeding tube and needle (Eco)
JG-466 Vaccination syringe 5 ml, with vial holder (Eco)

JG-994A Spray de silicona, 400ml
JG-994B Spray de vaselina, 400ml

JG-994A Silicone spray, 400 ml
JG-994B Vaseline spray, 400 ml



JG-994C Spray de grasa al Litio, 200ml

JG-994C Lithium grease spray, 200 ml

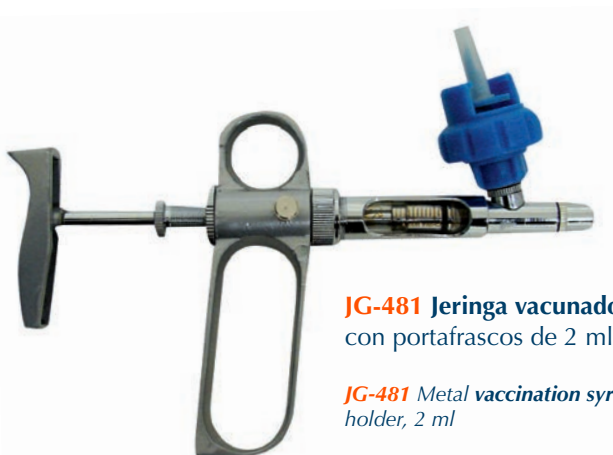

JG-481 Jeringa vacunadora metálica con portafrascos de 2 ml

JG-481 Metal vaccination syringe with vial holder, 2 ml

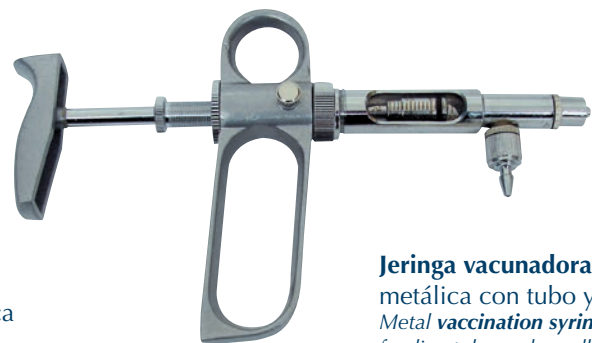

Jeringa vacunadora metálica con tubo y aguja
Metal vaccination syringe with feeding tube and needle

JG-480 2 ml
JG-485 10 ml

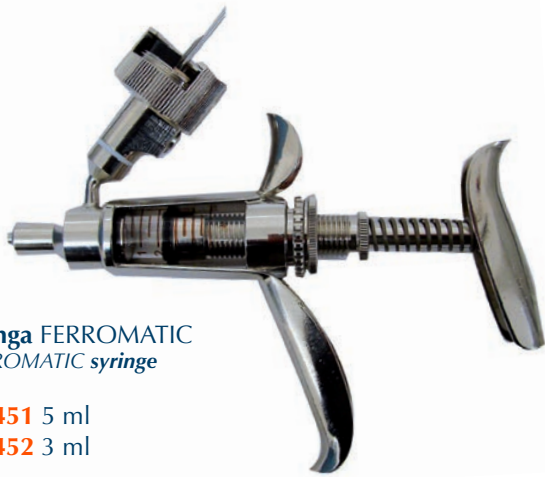

Jeringa FERROMATIC
FERROMATIC syringe

JG-451 5 ml
JG-452 3 ml



Jeringa VET-MATIC
VET-MATIC syringe

JG-450 5 ml
JG-450A 10 ml



Jeringa ECO-MATIC con tubo
ECO-MATIC syringe with feeding tube

JG-769 de 1 ml
JG-770 de 2 ml
JG-771 de 5 ml



Jeringa ECO-MATIC con set adaptadores universal
ECO-MATIC syringe with universal adaptors

JG-773 de 0,3 ml
JG-772 de 0,5 ml
JG-773A de 1 ml
JG-773B de 2 ml
JG-773C de 5 ml

Modelo ECO-GRIS
ECO-GRIS Model

JG-763 de 2 ml
JG-763A de 5 ml

Modelo ECO-GRIS
ECO-GRIS Model

JG-763E de 1 ml
JG-763F de 2 ml
JG-763G de 5 ml



Jeringa ECO-MATIC con porta-frascos
ECO-MATIC syringe with vial holder

JG-765 de 0,3 ml
JG-766 de 1 ml
JG-767 de 2 ml
JG-768 de 5 ml

Modelo ECO-GRIS
ECO-GRIS Model

JG-763B de 1 ml
JG-763C de 2 ml
JG-763D de 5 ml

JG-774 Adaptador negro portafrascos
reconvertido a tubo

JG-774 Black bottle holder adapter converted to tube



JG-774B Juego de 3 capuchones portafrascos con salida manguera

JG-774B Set of 3 bottle holder caps with hose outlet

Jeringas revólver y vacunadoras

Gun syringes / Vaccinators



Jeringa SERENA con porta frascos delantero
SERENA syringe with forward vial holder

JG-743 1 ml
JG-745 2 ml



Jeringa SERENA con tubo de aspiración
SERENA syringe with suction tube

JG-744 1 ml
JG-746 2 ml
JG-748 5 ml
JG-751 12 ml



Jeringa SERENA con porta frascos
SERENA syringe with vial holder

JG-745A 2 ml
JG-748A 5 ml



JG-754G Jeringa SERENA de 2+2
(Con dosificador independiente)
JG-754G SERENA 2+2 SYRINGE
(WITH INDEPENDENT DISPENSER)



JG-749 Jeringa SERENA de 5 ml con alargado 40 cm con portafrascos trasero
JG-753 Jeringa SERENA de 12 ml con alargado 40 cm con portafrascos trasero

JG-749 SERENA 5 ml syringe with 40 cm extension with rear bottle holder
JG-753 SERENA 12 ml syringe with 40 cm extension with rear bottle holder



Jeringa SERENA "montada" con alargado
SERENA syringe "mounted" with extension

JG-755 De 5 ml con alargado de 35 cm
JG-756 De 5 ml con alargado de 50 cm
JG-757 De 2 ml con alargado de 35 cm
JG-758 De 2 ml con alargado de 50 cm
JG-758A De 12 ml con alargado de 35 cm
JG-758B De 12 ml con alargado de 50 cm

JG-755 SERENA 5 ml syringe with 35 cm extension
JG-756 SERENA 5 ml syringe with 50 cm extension
JG-757 SERENA 2 ml syringe with 35 cm extension
JG-758 SERENA 2 ml syringe with 50 cm extension
JG-758A SERENA 12 ml syringe with 35 cm extension
JG-758B SERENA 12 ml syringe with 50 cm extension



Kit recambio, jeringa SERENA
SERENA syringe kit spare parts

JG-761 12 ml
JG-761A 5 ml
JG-761AA 2 ml



Jeringa SERENA con alargado de 40 cm o de 70 cm
SERENA syringe with extension (40 cm or 70 cm)

JG-750 5 ml (40 cm)
JG-752 12 ml (40 cm)
JG-754 12 ml (70 cm)

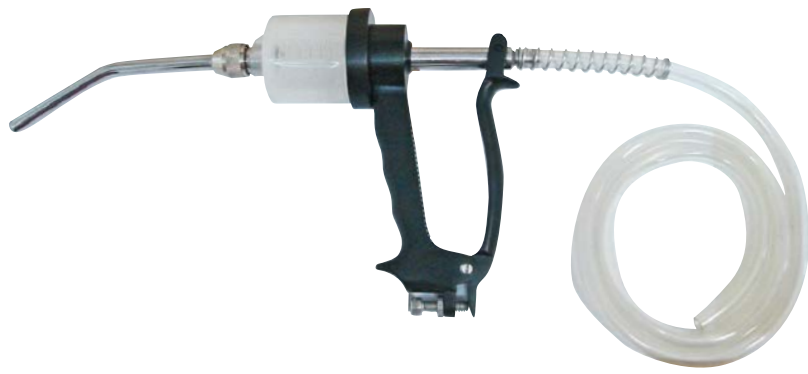

JG-641 Jeringa dosificadora bucal, de 70 ml

JG-641 Drenching syringe with cannula (70 ml)



JG-640 Jeringa dosificadora bucal de 30 ml

JG-640 Drenching syringe with cannula (30 ml)



JG-638 Jeringa dosificadora bucal STARVET, 10 ml

JG-638 STARVET oral drenching syringe, 10 ml



JG-637 Jeringa Pour-on STARVET, 10 ml

JG-637 STARVET Pour-on syringe, 10 ml



JG-636A Jeringa vacunadora-dosificadora bucal de 5 ml

JG-636A 5 ml vaccinator-oral drencher



JG-642 Cánula Pour-on para dosificadora bucal

JG-642 Oral cannula



JG-644EE Adaptador completo con r cord Luer Lock

JG-644EE Luer Lock complete adaptor

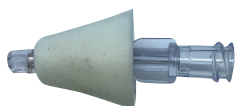

JG-636 Aplicador vaporizador nasal con cono Luer Lock

JG-636 Nasal vaporizer applicator with Luer Lock cone

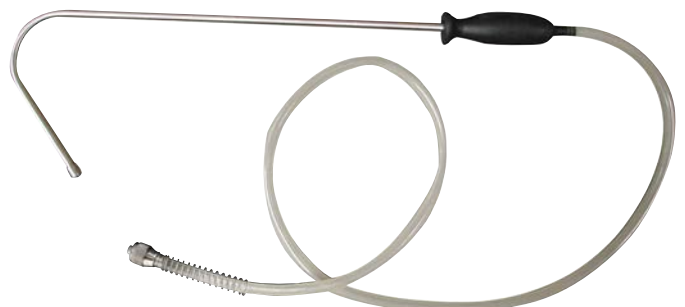

JG-643 Gancho bucal para dosificadora

JG-643 Oral hook for drenching syringe

Jeringas revólver y bucales

Gun syringes / Drenchers



Jeringa dosificadora bucal manual DRENCHER
DRENCHER hand oral drenching syringe

JG-676 70 ml
JG-677 100 ml
JG-678 120 ml
JG-679 150 ml

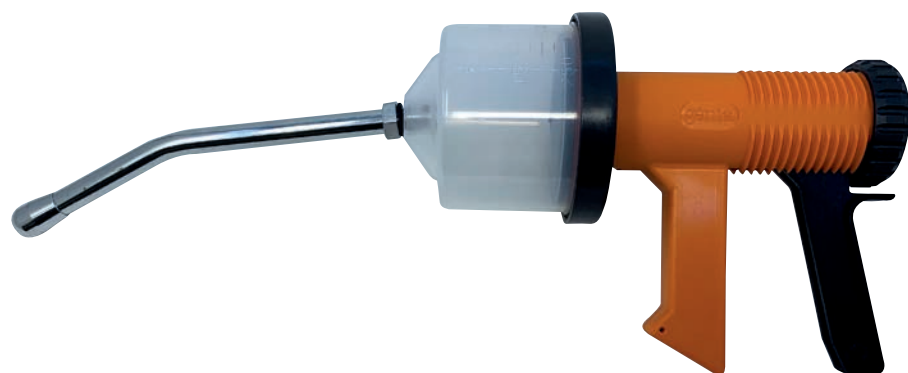

JG-740 Jeringa dosificadora bucal PISTOLMAN, 250ml

JG-740 PISTOLMAN drenching syringe, 250 ml

Jeringa dosificadora bucal azul
Blue drenching syringe



JG-732 200 ml
JG-734 300 ml (FLEX)
JG-735 500 ml



JG-730 35 ml
JG-731 70 ml



Cánula bucal cono Luer Lock universal
Oral cannula Luer lock cone

JG-118 12 cm
JG-119 17 cm



JG-673 Adaptador de aguja Luer Lock

JG-673 Needle adaptor Luer Lock



Jeringa dosificadora bucal automática
Automatic drenching syringe with cannula

JG-670 30 ml, sin mochila
JG-675 60 ml, sin mochila

JG-670 30 ml, without container
JG-675 60 ml, without container



JG-488 Jeringa PHILIPS de 15ml
JG-488 15ml PHILIPS syringe



Dosificador bucal DRENCHMATIC
DRENCHMATIC drenching syringe with cannula

JG-669 30 ml
JG-669AA 23 ml



Jeringa PISTOLMATIC
PISTOLMATIC syringe

JG-710 20 ml
JG-715 50 ml

JG-680 Jeringa dosificadora bucal manual, 300 ml

JG-680 Hand drenching syringe with cannula, 300 ml



Jeringas revólver y bucales

Gun syringes / Drenchers



JG-650 Depósito para dosificador bucal completo, 3 l

JG-650 Complete container for drenching syringe (3 l)



JG-649 Depósito transparente para dosificador bucal completo, 3 l

JG-649 Complete transparent container for oral drencher, 3 l



JG-648 Depósito completo de 3 l, plano transparente para dosificador bucal

JG-648 Complete transparent container, flat for oral drencher, 3 l



Tapones de recambio completos
Complete replacement caps

JG-991 Para depósito JG-990 y JG-990A

JG-991A Para depósito JG-990AA

JG-991B Para depósito JG-990AB sin tubo/entrada de aire

JG-991 For container JG-990 and JG-990A

JG-991A For container JG-990AA

JG-991B For container JG-990AB without tube/air inlet

JG-651 Para depósito JG-649 y JG-650

JG-648A Para depósito JG-648

JG-651 For container JG-649 and JG-650

JG-648A For container JG-648



JG-990AA Depósito completo de 3 l, plano transparente vacunadoras STARVET

JG-990AB Depósito completo de 3 l, plano transparente vacunadoras STARVET, sin tubo/entrada de aire

JG-990AA 3 l complete container, flat transparent STARVET vaccinators

JG-990AB 3 l complete container, flat transparent STARVET vaccinators, without tube/air inlet



JG-990A Depósito completo de 3 l, transparente para vacunadoras STARVET

JG-990A Complete transparent container, 3 l STARVET vaccinators



JG-990 Depósito completo de 3 l para vacunadoras STARVET

JG-990 Complete container, 3 l STARVET vaccinators



JG-997 Botella completa con cinturón STARVET, 1 l

JG-997 Complete STARVET bottle with belt, 1 l



JG-172H Jeringa de tuberculina tipo revólver
JG-172F Cristal para jeringa de tuberculina tipo revólver

JG-172H Syringe for tuberculin injection, gun form
JG-172F Glass for tuberculin syringe, gun form

JG-174 Jeringa de tuberculina HAUPTNER 5ml (de 0,1 a 0,4 ml)
JG-174A Cilindro para jeringa de tuberculina HAUPTNER de 5 ml

JG-174 HAUPTNER syringe for tuberculin 5 ml (0,1 to 0,4 ml)
JG-174A HAUPTNER cylinder for tuberculin syringe (5 ml)



AG-220 Agujas de tuberculina HAUPTNER tipo bayoneta, caja de 12 uds

AG-221 Agujas de tuberculina HAUPTNER cono Luer Lock, caja de 12 uds

AG-220 HAUPTNER tuberculin needles, bayonet-type cone, box of 12 pcs

AG-221 HAUPTNER tuberculin needles, Luer Lock-type cone, box of 12 pcs



AG-218 Aguja de tuberculina STARVET cono Luer Lock, caja de 12 uds

AG-218 STARVET Luer Lock tuberculin needles, box of 12 pcs



JG-173 Jeringa de tuberculina HAUPTNER con cono tipo bayoneta

JG-217 Cristal para jeringa de tuberculina HAUPTNER

JG-173 HAUPTNER syringe for tuberculin injection, bayonet-type cone
JG-217 HAUPTNER glass for tuberculin syringe

GROTEERMAN®

Jeringa de inoculación intradérmica de la Tuberculina en la prueba IDTB en ganado bovino
Para la inyección intradérmica de dosificación de 0,1ml.
Testada por VISAVET (Centro de Vigilancia Sanitaria Veterinaria)

*Tuberculin intradermal inoculation syringe for tuberculin tests in cattle.
0.1ml intradermal dosage.
Tested by VISAVET (Veterinary Sanitary Surveillance Center)*

INYECTA

**Sin contacto
Sin aguja**



INJECTS

**without contact
without needle**



JG-900 Jeringa intradérmica GROTEERMAN

JG-900 GROTEERMAN intradermal syringe

- Bovino, ovino, caprino y cunícola
- Cattle, sheep, goats and rabbits



UNIVERSIDAD
COMPLUTENSE
MADRID

Sistema APTO para la IDTB (Intradermotuberculinización)

Approved system for tuberculin intradermal inoculation





JG-172E Cutímetro para prueba de tuberculina analógico

JG-172E Analog calliper for tuberculin test

JG-172EH Cutímetro para tuberculina analógico con muelle para zurdos

JG-172EH Analog tuberculin calliper with spring for left-handed



JG-172EE Cutímetro para tuberculina analógico con muelle

JG-172EE Analog calliper with spring for tuberculin

JG-172CC Cutímetro analógico tipo pistola HAUPTNER

JG-172CC HAUPTNER gun type analog tuberculin calliper



JG-172A Cutímetro con reloj

JG-172A tuberculin calliper with watch



JG-172B Cutímetro digital tipo pistola HAUPTNER

JG-172B HAUPTNER gun type digital tuberculin calliper

Nebulizadores / Garrochas / Cerbatanas

Air sprayers / Garrocha vaccinator / Blow pipes



- JG-880** Nebulizador para vacunas TURBAIR de 12 V
- JG-881** Batería para TURBAIR de 12 V
- JG-882** Cargador para baterías TURBAIR de 12 V
- JG-883** Mochila con cable para baterías TURBAIR de 12 V

JG-880 TURBAIR air-assisted sprayer for vaccines, 12V
JG-881 TURBAIR battery, 12V
JG-882 TURBAIR battery charger, 12V
JG-883 TURBAIR bag with cable for batteries, 12V



- JG-875** Nebulizador para vacunas TURBAIR a 220 V

JG-875 TURBAIR air-assisted sprayer for vaccines, 220V



- JG-690** Vacunador de garrocha con rosca, 26 ml

JG-690 "Garrocha" vaccinator with screw hub, 26 ml



- JG-692** Vacunador de garrocha STARVET con cono Luer-Lock, 30 ml

JG-692 STARVET "Garrocha" vaccinator 30 ml with Luer-Lock hub



Aguja de rosca para vacunador de garrocha JG-690
Spare screw hub needle for "Garrocha" vaccinator JG-690

- JG-699** 20x30
- JG-700** 25x30



Aguja Luer-Lock para vacunador de garrocha JG-692
Luer-Lock needle for "Garrocha" vaccinator JG-692

- JG-698** 20x30
- JG-698A** 25x30



- JG-695** Mango para vacunador de garrocha, 3 m

JG-695 Handle for "garrocha" vaccinator, 3 m



- IC-505** Cerbatana completa

IC-505 Complete blowpipe



Material de inseminación artificial para conejos

*Artificial insemination products
for rabbits*







JG-901C Jeringa automática con cánula recta para I.A. conejos STARVET, 1 ml

JG-901C STARVET automatic syringe with straight cannula for rabbit A.I., 1 ml



JN-180 Jeringa neumática intradérmica de conejos de 0,1 ml

JN-180 Intradermal pneumatic syringe for rabbits (0.1 ml)



IA-889 Jeringa completa con cánula metálica para I.A. conejos, 1 ml

IA-889 Syringe with cannula for rabbit A.I., 1 ml

GROTEERMAN®



JG-900 Jeringa intradérmica GROTEERMAN
JG-895 Jeringa intradérmica GROTEERMAN con cabezal de 3 salidas

JG-900 GROTEERMAN *Intradermal syringe*
JG-895 GROTEERMAN *Intradermal syringe* with 3-outlet head



JG-900A Jeringa intradérmica automática GROTEERMAN
JG-900B Jeringa intradérmica automática GROTEERMAN con cabezal de 3 salidas

JG-900A GROTEERMAN *Intradermal automatic syringe*
JG-900B GROTEERMAN *Intradermal automatic syringe* with 3-outlet head



JG-890 Cabezal de 3 salidas para jeringas GROTEERMAN

JG-890 3-exhaust head for GROTEERMAN syringes

DESPIECE JERINGA GROTEERMAN
GROTEERMAN SYRINGE SPARES

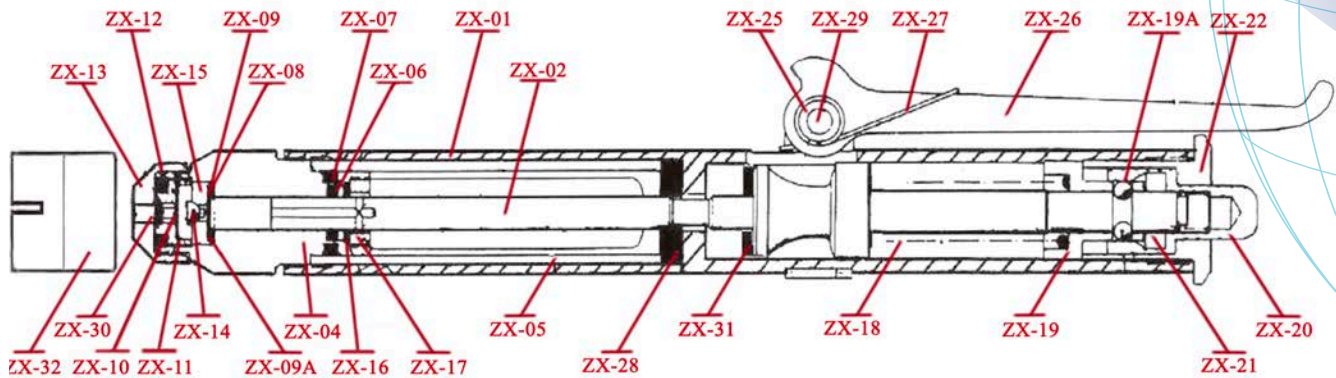

- | | | | |
|----------------|-----------------------------|----------------|-----------------------------------|
| ZX-01.- | CUERPO DESCUBIERTO | ZX-17.- | TUERCA DE CARA DE SOPORTE |
| ZX-02.- | CONJUNTO PISTÓN | ZX-18.- | MUELLE PRINCIPAL |
| ZX-04.- | CABEZA EYECCIÓN DESCUBIERTA | ZX-19.- | CAJA DE BOLAS |
| ZX-05.- | TUBO DE DEPÓSITO | ZX-19A.- | BOLAS |
| ZX-06.- | JUNTA TÓRICA R3 PISTÓN | ZX-20.- | BOTÓN DE SUELTA |
| ZX-07.- | JUNTA TÓRICA R7 (Dep. Inf.) | ZX-21.- | MUELLE DEL BOTÓN |
| ZX-08.- | ARANDELA TEFLÓN | ZX-22.- | TUERCA DE LA CABEZA |
| ZX-09.- | FILTRO GORDO | ZX-25.- | CASQUILLO DE PALANCA |
| ZX-09A.- | FILTRO FINO | ZX-26.- | PALANCA ARMAMENTO |
| ZX-10.- | MUELLE DE VÁLVULA | ZX-27.- | MUELLE ALFILER DE PALANCA |
| ZX-11.- | ASIENTO DE PASTILLA | ZX-28.- | JUNTA TÓRICA SUPERIOR DE DEPÓSITO |
| ZX-12.- | JUNTA TÓRICA DE CABEZA | ZX-29.- | EJE DE PALANCA |
| ZX-13.- | TUERCA DE PASTILLA | ZX-30.- | INYECTOR RUBÍ |
| ZX-14.- | VÁLVULA | ZX-31.- | JUNTA DENTRO DEL COLLARÍN |
| ZX-15.- | ASIENTO DE VÁLVULA | ZX-32.- | CONTERA |
| ZX-16.- | CARA DE SOPORTE | | |

- ZX-01.- *OUTSIDE BODY*
 ZX-02.- *PISTON*
 ZX-04.- *EJECTION HEAD*
 ZX-05.- *DEPOSIT BARREL*
 ZX-06.- *R3 WASHER*
 ZX-07.- *R7 WASHER*
 ZX-08.- *TEFLON WASHER*
 ZX-09.- *BIG FILTER*
 ZX-09A.- *SMALL WASHER*
 ZX-10.- *VALVE SPRING*
 ZX-11.- *SEAT*
 ZX-12.- *HEAD TORIC WASHER*
 ZX-13.- *NUT*
 ZX-14.- *VALVE*
 ZX-15.- *VALVE SEAT*
 ZX-16.- *SUPPORT PART*

- ZX-17.- *SUPPORT NUT*
 ZX-18.- *MAIN SPRING*
 ZX-19.- *BALL BOX*
 ZX-19A.- *BALLS*
 ZX-20.- *BUTTON*
 ZX-21.- *BUTTON SPRING*
 ZX-22.- *HEAD NUT*
 ZX-25.- *LEVER SLEEVE*
 ZX-26.- *LEVER*
 ZX-27.- *LEVER SPRING*
 ZX-28.- *UPPER TORIC WASHER*
 ZX-29.- *LEVER AXIS*
 ZX-30.- *RUBY INJECTOR*
 ZX-31.- *INSIDE WASHER*
 ZX-32.- *TIP*



IB-725 Báscula digital hasta 20 kg para pesar animales

IB-725 Digital scale (up to 20 kg) for animals



IA-873A Diluyente para semen conejos vial de 250 ml (500 dosis)

IA-873A Rabbit semen extender, 250 ml (500 doses flask)



IA-864 Colector de semen conejos de 5 ml

IA-864 Rabbit semen tubes 5 ml



IA-855 Vagina artificial conejos

IA-855 Rabbit artificial vagina



IA-853 Vagina artificial de silicona para conejos

IA-853 Silicon artificial vagina for rabbits



IA-860 Cámara recolectora conejos

IA-860 Rabbits collector sheath



IA-875 Colector diluido de 50 ml, paq. de 25 uds

IA-875 Diluted substance tube, 50 ml
Box of 25 units

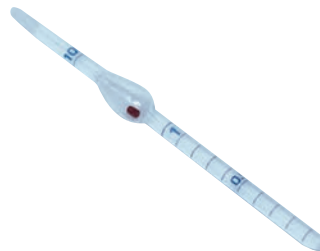

IA-915 Pipeta para contaje de semen conejo

IA-915 Pipette for semen measuring



IA-880 Envoltorio térmico

IA-880 Thermic cover

Inseminación conejos

Rabbit insemination



IA-887 Cánulas curvadas de vidrio

IA-887 Glass curved cannulas

IA-884 Cánulas curvadas desechables, paquete de 100 unidades

IA-885 Cánulas curvadas desechables INSERBO (Mdo-A), paquete de 100 unidades

IA-884 Disposable curved cannulas, box of 100 units

IA-885 INSERBO disposable curved cannulas (A model), box of 100 units

IA-888 Cánulas rectas desechables, paquete de 100 unidades

IA-888A Cánulas rectas desechables INSERBO, paquete de 100 unds

IA-888 Disposable straight cannulas, box of 100 units

IA-888A INSERBO disposable straight cannulas, box of 100 units

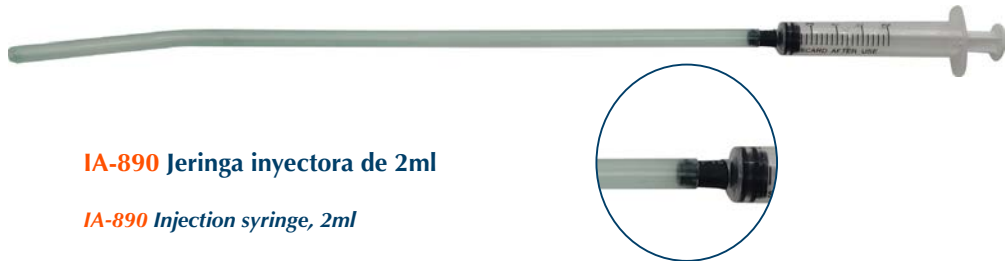

IA-890 Jeringa inyectora de 2ml

IA-890 Injection syringe, 2ml

JG-901C Jeringa automática STARVET con cánula recta para I.A. conejos, 1 ml

JG-901C STARVET automatic syringe with straight cannula for rabbit A.I., 1 ml



JG-998A Depósito completo para vacunadora STARVET, de 50 ml

JG-998A Complete container for STARVET vaccinator, 50 ml



IA-850 Máquina para llenado de dosis seminales de conejos

IA-850 Rabbit sperm dosage filling machine





Ecógrafo portátil INSERBO FUTURE-1



4 modos de pantalla
4 screen modes

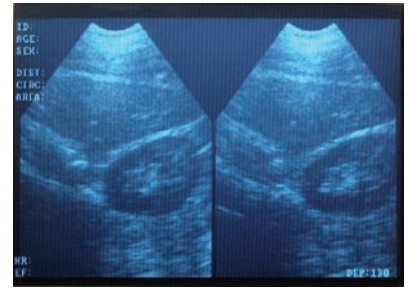

Modo B+B
B+B Mode

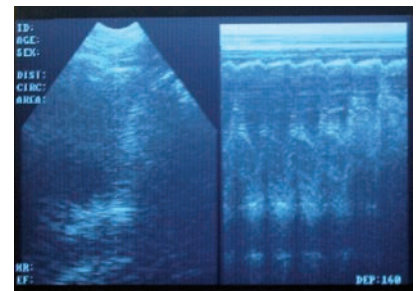

Modo B+M
B+M Mode

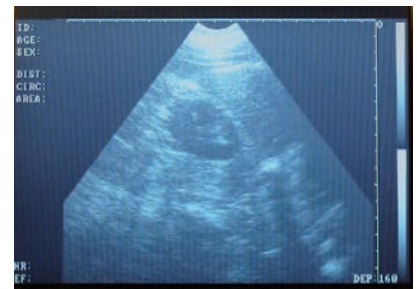

Modo B
B Mode

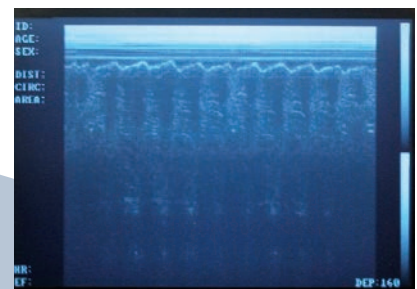

Modo M
M Mode

Un gigante en miniatura

*INSERBO portable scanner
A giant in miniature*

DG-500 Ecógrafo portátil FUTURE-1

DG-500 Portable scanner FUTURE-1

14,5 cm x 11,5 cm x 4 cm y 595 g
(medidas y peso. ¡CON BATERÍA INCLUIDA!)
(Size and weight WITH BATTERIES INCLUDED!)

Gigante por prestaciones, miniatura por precio y tamaño
Giant in performance, miniature in price and size

Ecógrafos Scanners



DG-655 Corraje de sujeción para ecógrafo FUTURE-1

DG-655 FUTURE-1 holding straps



DG-660 Kit para muñeca ecógrafo FUTURE-1

DG-660 FUTURE-1 wrist kit



DG-545 Vídeo gafas para ecógrafo FUTURE-1

DG-545 Video glasses for FUTURE-1 scanner



DG-570 Sonda multifrecuencial FUTURE-1

DG-570 FUTURE-1 multifrequency probe



DG-550 Batería de recambio FUTURE-1

DG-550 FUTURE-1 spare battery



DG-555 Cargador para automóvil FUTURE-1, 12 V

DG-555 Car charger for FUTURE-1 scanner, 12v



DG-560 Cargador FUTURE-1, 110/220 V

DG-560 Charger for FUTURE-1 scanner, 110/220 v

Ecógrafo portátil INSERBO **FUTURE WIFI**

DG-750 Sonda para ecografía FUTURE-WIFI completa con maleta

DG-750 FUTURE-WIFI *ultrasound probe* complete with case



- Superficie ergonómica y antideslizante
- Mas de 3 horas de batería
- Parada de imagen en la soinda
- Funciona con una APP
- Waterproof

- *Ergonomic and anti-slip*
- *More than 3 hours of battery*
- *Image freeze in sound*
- *Works with an APP*
- *Waterproof*



Kit de muñeca o Correa de sujeción

Wrist kit or Holding straps



DG-760 Tablet con pantalla de 7" waterproof IP-68 y antigolpes

DG-760 *Tablet with 7" screen waterproof and shockproof*

Tablet a prueba de polvo, agua y golpes
Dust, water and shock proof tablet



Ecógrafo portátil INSERBO FUTURE-2



DG-475 Ecógrafo portátil FUTURE-2

DG-475 Portable scanner FUTURE-2

DIMENSIONES DIMENSIONS



DG-481 Sonda de recambio Waterproof para FUTURE-2

DG-481 Waterproof spare probe for FUTURE-2



DG-480 Batería de recambio para FUTURE-2

DG-480 Spare battery for FUTURE-2



STARVET-SONIC

DG-200 Gel de ecógrafo STARVET-SONIC, 5.000 ml

DG-200 STARVET-SONIC scanner gel, 5,000 ml



DG-700 Ecógrafo portátil con batería y sonda lineal transrectal

DG-700 Portable scanner with battery and transrectal liner probe



IP-117 Rollo de tubo plástico, para sondas de 400 m

IP-117 Plastic tube for probes, 400 m



DG-220 Toallitas desinfectantes para instrumentos y aparatos veterinarios, de 150 uds

DG-220 Disinfectant towels for veterinary instruments, 150 units



DG-210 Desinfectante para ecógrafos y sondas

DG-210 disinfectant for scanners and probes



DG-130B Detector de gestación Preg-Tone

DG-130B Preg-Tone gestation detector

DG-123 Medidor de grasa LEAN METER

DG-123 LEAN METER fat meter



DG-122 Medidor de grasa con lector de chips INSERBO

DG-122 INSERBO fat meter with chip reader



IC-290 Pistola para extracción de grasa

IC-290 Fat extraction pistol

Detectores / Triquinoscopios / Digestores

Detectors / Trichinoscopes / Digestors



IT-149A Triquinoscopio de pantalla (modelo homologado)

IT-149A Screen trichinoscope (officially approved model)



IT-149 Triquinoscopio de pantalla

IT-149 Trichinoscope with screen

IT-159 Ácido Clorhídrico (HCL) 25% 1L

IT-159 Hydrochloric Acid (HCL) 25% 1Lt

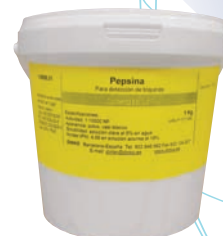

Pepsina / Pepsin

IT-159A De 1 kg
IT-159B Paquete de 50 x 10 g
IT-159BB Paquete de 10 x 10 g
IT-159BC Sobre de 5 g

*IT-159A 1 kg
 IT-159B Package of 50x10 g
 IT-159BB Package of 10x10 g
 IT-159BC Envelope of 5 g*



IT-150 Compressor para triquina de 28 casillas HAUPTNER

IT-150 HAUPTNER compressor for trichina with 28 divisions



IT-159D Embudo decantador de separación de 2 l con llave Teflón

IT-159D Separatory funnel 2 l with PTFE stop



IT-159H Tamiz Inox 100 mm diámetro malla, 0,180 mm luz

IT-159H Stainless steel 100 mm sieve, 0.180 mm light



IT-156 Digestor para análisis de carnes completo con bomba y mueble

IT-156 Digester for meat analysis with pump and holder



IT-158 Digestor-Equipo para detección de triquina

IT-158 Digester for trichina detection



Esta cámara de vídeo se adapta al ocular de la gran mayoría de los microscopios sin ser necesario un adaptador opcional.

Video camera adaptable to the majority of microscopes. No adaptor needed.



IA-150 Cámara de vídeo y monitor de 12" para microscopios (b/n)

IA-152 Cámara de vídeo y monitor de 10" para microscopios (color)

IA-150 Video camera and monitor of 12" for microscopes (B/W)

IA-152 Video camera and monitor of 10" for microscopes (color)

Cámara de vídeo para microscopio
Video camera for microscope

IA-153 Conexión a ordenador

IA-153A Conexión a ordenador, alta resolución

IA-153B Conexión a ordenador, alta resolución (7)

IA-153 Computer connection

IA-153A High resolution computer connection

IA-153B High resolution computer connection (7)



IA-106 Microscopio triocular con luz halógena de 1.500X (contraste de fases)

Accesorios principales:

- Set simple polarizador
- Kit de contraste de fases con objetivos planos acromáticos: PH10X, PH20X(S), PH40X(S), PH100X(S OIL)
- Condensador anular de contraste de fases
- Telescopio centrador, filtro verde

IA-106 Trinocular microscope with halogen light, 1500X (phase contrast kit)

Main accessories:

- Simple polarization set
- Turret phase contrast kit with plan-achromatic objectives: PH10X, PH20X(S), PH40X(S), PH100X(S OIL)
- Turret annular phase contrast condenser
- Centering telescope, green filter

CARACTERÍSTICAS / CHARACTERISTICS

CABEZAL: cabezal triocular Sidentopf (inclinación de 30°)	VIEWING HEAD: Sidentopf trinocular head (30° inclined)
OCULAR: WF 10X/20WF 15X/15	EYEPIECE: WF 10X/20 WF 15X/15
REVÓLVER: revólver cuádruple	NOSEPIECE: Inward quadruple nosepiece
OBJETIVOS: (Sistema iOS) acromáticos 4X, 10X, 40X, 100X	OBJECTIVES: (iOS system) Achromatic 4X, 10X, 40X, 100X
CARRO/PLATINA: 135 x 153 mm. Platina mecánica rango de movimiento: 80 x 50 mm	STAGE: 135 x 153 mm mechanical stage moving range: 80 x 50 mm
CONDENSADOR: condensador Abbe N,A.1.25	CONDENSER: N.A.1.25 Abbe condenser
AJUSTE: control de ajuste con mandos coaxiales y ajuste de precisión	FOCUSING: coaxial coarse and fine focusing controls
RECOLECTOR: recolector con diafragma de campo	COLLECTOR: Collector with field diaphragm
ILUMINACIÓN: lámpara halógena de 6 V 20 W	ILLUMINATION: 6 V 20 W halogen lamp
FILTRO: azul, amarillo, verde	FILTER: Blue, yellow, green
ENVOLTORIO: caja y envase de poliestireno	PACKING: Styrofoam box and carton

Microscopios Microscopes



IA-101 Microscopio monocular de 1.600X con luz halógena

IA-101 Monocular microscope with halogen light, 1600X



IA-102 Microscopio binocular de 1.600X con luz halógena

IA-102 Binocular microscope with halogen light, 1600X



IA-103 Microscopio monocular de 1.600X con luz

IA-103 Monocular microscope with light, 1600X



IA-104 Microscopio binocular de 1.600X con luz halógena

IA-104 Binocular microscope with halogen light, 1600X



IA-105 Microscopio trinocular de 1.600X con luz halógena (adaptable a cámara de vídeo)

IA-105 Trinocular microscope with halogen light, 1600X (adaptable to video camera)



IA-151 Cámara con pantalla integrada para microscopios

IA-151 Video camera with integrated monitor for microscopes



IA-110 Estereomicroscopio binocular con zoom XT-203

*IA-110 Binocular **stereomicroscope** with zoom XT-203*



IA-111 Estereomicroscopio binocular sin zoom XT-202

*IA-111 Binocular **stereomicroscope** without zoom XT-202*



IA-180 Refractómetro de mano clínico con compensación automática de temperatura

*IA-180 Pocket clinical **refractometer** with automatic temperature compensation*



IA-175 Ovoscopio con mango y bombilla de 60 W

*IA-175 **Ovoscope** (including handle and lamp 60 W)*

Estereomicroscopios / Estufas / Centrifuga

Stereomicroscopes / Stoves / Centrifuge



Modelo analógico

IA-200B Estufas para desecación, esterilización y de cultivos

IA-200B Drying, sterilizing and culture stoves

Todos los modelos están también disponibles con circulación forzada de aire, función de doble temperatura, microprocesador digital electrónico de temperatura y tiempo.

- Estufas con regulación para desecación
- Convección natural de aire (IA-200B)
- Convección forzada de aire (IA-200BC)
- Temperatura regulable desde ambiente desde +5 °C hasta 220 °C
- Termómetro lector de temperatura hasta 250 °C
- 2 bandejas interiores en acero inoxidable

All models available with forced air circulation, double temperature function, time and temperature electronic and digital microprocessor

- With regulation
- Natural air convection (IA-200B)
- Forced air convection (IA-200BC)
- Temperatures from +5°C to 220°C
- Thermometer to read temperatures up to 250°C
- 2 interior stainless steel trays

CÓDIGO CODE	CAPACIDAD l LITRE CAPACITY	MEDIDAS EXTERIORES EXTERIOR MEASURES			MEDIDAS INTERIORES INTERIOR MEASURES			CONSUMO W	PESO WEIGHT
		Alto HIGH	Ancho WIDE	Fondo DEEP	Alto HIGH	Ancho WIDE	Fondo DEEP		
IA-200B	80	66	77	46	48	48	35	1230	49
IA-200BC	72	75,5	52,2	55	49,6	40,2	40,5	1120	49



IA-200BC Estufa para desecación y esterilización de 72 l digital INSERBO

IA-200BC Drying and sterilization oven of 72l digital INSERBO

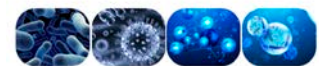

IA-190 Esterilizador de 7L rayos ultravioleta (UV)

IA-190 7L ultraviolet (UV) sterilizer



IA-286 Centrifuga de 6 tubos

IA-286 6-tube centrifuge



IA-286A Centrifuga de 6 tubos con temporizador

IA-286A 6-tube centrifuge with timer

Baños maría INSERBO de acero Inox, con bandeja protectora

INSERBO stainless steel waterbaths, with protecting tray

Los baños maría INSERBO son de acero Inox, tanto la cubeta interior como el mueble exterior. Incorporan de serie termostato de seguridad que desconecta el baño en caso de sobret temperatura. Bandejas protectoras cubre resistencias en acero Inox.

INSERBO waterbaths are made of stainless steel. They are equipped with a safety thermostat that disconnects the boiler in case of overtemperature. The protecting trays that cover the resistance are also made of stainless steel.



IA-208 Analógico, 5 l **IA-208** Analogical, 20 l
IA-208D Digital, 5 l **IA-208D** Digital, 20 l



IA-212 Analógico, 12 l **IA-212** Analogical, 12 l
IA-212D Digital, 12 l **IA-212D** Digital, 12 l



IA-214 Analógico, 20 l **IA-214** Analogical, 20 l
IA-214D Digital, 20 l **IA-214D** Digital, 20 l



Tapas para baños maría

Lids for water baths



IA-218 Digital, 50 l
IA-218 Digital, 50 l



IA-217 Analógico, 45 l **IA-217** Analogical, 45 l
IA-217D Digital, 45 l **IA-217D** Digital, 45 l

CÓDIGO CODE	TEMP. MÁXIMA MAX. TEMPERATURE	CAPACIDAD / LITRE CAPACITY	CONSUMO W	MEDIDAS EXTERIORES EXTERIOR MEASURES			MEDIDAS ÚTILES CM USEFUL MEASURES CM		
				Alto HIGH	Ancho WIDE	Fondo DEEP	Alto HIGH	Ancho WIDE	Fondo DEEP
IA-208/208D	110 °C	5	600	24	33	18	15	30	15
IA-212/212D	110 °C	12	1200	24	36	33	15	33	30
IA-214/214D	110 °C	20	1600	24	53	33	15	51	30
IA-217/217D	110 °C	45	2500	24	63	53	15	62	50
IA-218	110 °C	50	2500	36	89	50	20	74	40

Baños maría / Agitadores

Waterbaths / Magnetic stirrer



IA-202 Baño maría analógico
IA-202 Analogical waterbath



IA-202D Baño maría digital
IA-202D Digital waterbath

Baños maría INSERBO, de 12 l con tapa y bandeja Inox. Con termostato analógico o digital. Para calentar las dosis de semen a 37 °C por agua caliente (*).

INSERBO water bath (12 litres) with stainless steel lid and tray. To heat semen (37°C with hot water) (). Analogical or digital thermostat*

Imprescindible para mirar muestras de semen en el microscopio (calor uniforme en toda su superficie)

Essential to study semen samples on the microscope (uniform heating)



IA-255 Placa calentable digital INSERBO.
IA-254 Placa calentable digital de precisión INSERBO.

IA-255 INSERBO digital heatable plate.
IA-254 INSERBO precision digital heatable plate.



IA-139A Platina calentable digital INSERBO
 (instalada en microscopio)

IA-139A INSERBO digital heatable plate (already assembled on microscope)



IA-256 Placa calentable para acoplar a carro microscopio

IA-256 Heatable plate to attach to microscope trolley



IA-244 Agitador magnético INSERBO con calefacción

IA-244 INSERBO *magnetic stirrer* with heating



IA-244A Agitador magnético digital INSERBO con calefacción sonda externa

IA-244A INSERBO *heatable magnetic stirrer* with external probe



IA-244B Agitador magnético calefactable con sonda externa digital

IA-244B *Heatable magnetic stirrer* with digital external probe



IA-247 Varilla recoge imanes

IA-245 Iman de 8 x 39 para agitador magnético

IA-247 *Bar* for magnet withdrawal

IA-245 8 x 39 *magnet* for magnetic stirrer

Cubetas para colorímetro *Colorimeter cubes*



IA-258 4 caras transparentes paq. de 100 u

IA-258 4 transparent sides, pack 100 units



IA-259 Colorímetro medical CO 7000

IA-260 Colorímetro CO 7500

IA-259 Medical *colorimeter* CO 7000

IA-260 *Colorimeter* CO 7500



IN-145B Contador manual, 5 teclas

IN-145B Analog *counter* with 5 keys

NEVERAS PARA CONSERVACIÓN DE SEMEN

En INSERBO, SL nos tomamos muy en serio las preocupaciones y problemas de nuestros clientes, por lo que diseñamos y fabricamos todas nuestras cámaras de conservación para que detecten y rectifiquen automáticamente un problema de temperatura antes de que este se manifieste y se dañen los productos en ellas almacenados.

Nuestras neveras de conservación controlan con el máximo de precisión la temperatura ambiente (aire) de su interior en el espacio máximo de tiempo de 1 minuto y, puesto que para variar la temperatura de cualquier sólido o líquido mediante la temperatura ambiente (el aire), es preciso un espacio de tiempo superior al minuto y conseguimos que nuestras neveras obtengan una precisión real de la temperatura del producto a conservar (dosis seminales, muestras, vacunas, etc...) de 0,5 °C a 1 °C , 0,2 °C a 0,5 °C y 0,2 °C a 0,1 °C según el modelo de nevera

SEMEN CONSERVATION REFRIGERATORS

We take our customers worries and problems very seriously and for this reason we design and manufacture all our refrigerators in a way that they automatically detect and solve any temperature problems before they arise and consequently avoiding any possible damage of the contents inside the refrigerator

Our conservation refrigerators control the inside air temperature with maximum precision and in a maximum period of time of 1 minute. In order to change the temperature of any solid or liquid by means of air temperature a period of 1 minute is required. This means that our refrigerators obtain real precision of the temperature of the contents inside the refrigerator (semen doses, vaccines etc.) from 0.5 °C to 1 °C, from 0.2 °C to 0.5 °C and from 0.2 °C to 0.1 °C depending on the model



PARA LA BIOSEGURIDAD EN GRANJAS Y CENTROS DE I.A

FOR BIOSAFETY ON FARM AND A.I. CENTERS

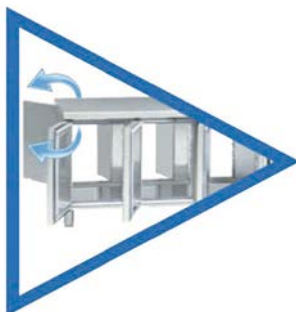

- IA-316A** Nevera de conservación de semen fija 2 puertas dobles pasantes
- IA-316B** Nevera de conservación de semen fija 3 puertas dobles pasantes
- IA-316C** Nevera de conservación de semen fija 4 puertas dobles pasantes

IA-316A Fixed semen storage refrigerator with 2 pass-through double doors
IA-316B Fixed semen storage refrigerator with 3 pass-through double doors
IA-316C Fixed semen storage refrigerator with 4 pass-through double doors

Puertas pasantes dotadas de bisagras con sistema de retorno automático y fijación de apertura

Pass-through doors equipped with hinges with automatic return system and opening fixation

Número de puertas Number of doors	Potencia (kW) Power	Dimensiones (mm) Dimensions
2	0,249	1342 x 778 x 850
3	0,249	1792 x 778 x 850
4	0,332	2242 x 778 x 850



Nevera de conservación de semen, 70 l
Semen conservation refrigerator (70 l)

IA-311 Modelo B (básico)

IA-310 Modelo N con microprocesador digital de zona neutra

IA-305 Modelo E con microprocesador digital de alta precisión, 0,1°C con economizador de consumo

IA-311 "B" model (basic)

IA-310 "N" model with digital microprocessor of neutral zone

IA-305 "E" model with digital high precision microprocessor (0.1 °C) with consumption economizer

Nevera de conservación de semen, 140 l
Semen conservation refrigerator (140 l)

IA-314 Modelo N con microprocesador digital de zona muerta

IA-313 Nevera de conservación de semen fija de 140 l, modelo E con ordenador

IA-314 "N" model with digital microprocessor of neutral zone

IA-313 Semen conservation refrigerator (140 l) "E" model with computer



IA-317 Estabilizador de corriente, 220 V

IA-317 Current stabilizer, 220V

CÓDIGO CODE	ZONA NEUTRA NEUTRAL ZONE	CAPACIDAD L LITRE CAPACITY	CONSUMO W	MEDIDAS EXTERIORES CM EXTERIOR MEASURES CM			MEDIDAS ÚTILES CM INTERIOR MEASURES CM		
				Alto High	Ancho Wide	Fondo Deep	Alto High	Ancho Wide	Fondo Deep
IA-305/310	SI - YES	70	75	62,5	47	44	52,5	40	34
IA-311	NO	70	75	66,5	47	44	52,5	40	34
IA-313/314	SI - YES	140	90	84	48	48	73,5	40	37
IA-314B	SI - YES	250	128	143	55	58	123	47	44
IA-315	SI - YES	360	200	183	59	60,5	156,5	53,5	44,5
IA-316	SI - YES	600	195	189	77,7	69,5	166	65,5	58

Neveras Conservation refrigerators



IA-314B Nevera de conservación de semen de 250 l Modelo N con microprocesador digital de zona neutra

IA-314B Semen conservation refrigerator (250 l) "N" model with digital microprocessor of neutral zone



IA-315 Nevera de conservación de semen fija de 360 l

IA-315 Semen conservation refrigerator (360 l)

IA-316 Nevera de conservación de semen fija de 600 l

IA-316 Semen conservation refrigerator (600 l)



- * Termostato con punto decimal y zona neutra
- * Cerradura con llave
- * Rejilla protectora en el compresor

- * Thermostat with decimal point and neutral zone
- * Lock with key
- * Protective grille on the compressor



Nevera para transporte de semen con compresor, 12 V
Semen carrying refrigerator with compressor, 12V

IA-335C 130 l
IA-335CA 100 l



Nevera de transporte de semen y vacunas con compresor 12 -220V
Semen and vaccines carrying refrigerator with compressor, 12-220V

IA-335B 110 l



Nevera de transporte para semen, 12-220 V
Semen carrying refrigerator, 12-220V

IA-324A 14 l
IA-322A 21 l
IA-320 35 l



Nevera de transporte para vacunas, 12-220 V
Carrying refrigerator for vaccines, 12-220V

IA-329A 14 l
IA-329D 21 l
IA-332 35 l



IA-326 Transformador para neveras de transporte, 220 V-12

IA-326 Transformer for carrying fridge, 220 to 12V



Nevera de transporte para vacunas con compresor, 12 V
vaccines carrying refrigerator with compressor, 12V

IA-331 25 l



IA-347A Nevera-bolsa isotérmica de 17 litros

IA-347A 17 liter isothermal cooler bag

Neveras de transporte / Selladoras

Semen carrying refrigerators / Sealers



IA-270 Esterilizador de catéteres
automático de 18 catéteres

IA-270 Automatic catheter sterilizer (18 units)



IA-279 Bomba peristáltica digital programable.
Para llenado de tubos y botellas

IA-279 Programmable digital peristaltic pump. To fill
bottles and tubes



IA-281B Selladora manual para
envasado de tubos

IA-281B Manual sealer for tube packaging



IA-281A Selladora automática para
envasado de tubos

IA-281A Automatic sealer for tube packaging



IA-281 Selladora para envasado de
6 a 8 tubos. 2.000 tubos/hora

IA-281 Sealer for tube packaging (6 to 8
tubes). (2,000 tubes/hour)



IA-282 Gradilla Inox para selladora de
tubos

IA-282A Gradilla Inox para selladora de
tubos doble (90, 30 ml)

IA-282 Stainless steel **holder** for tube packaging
IA-282A Stainless steel double **holder** (90, 30 ml)

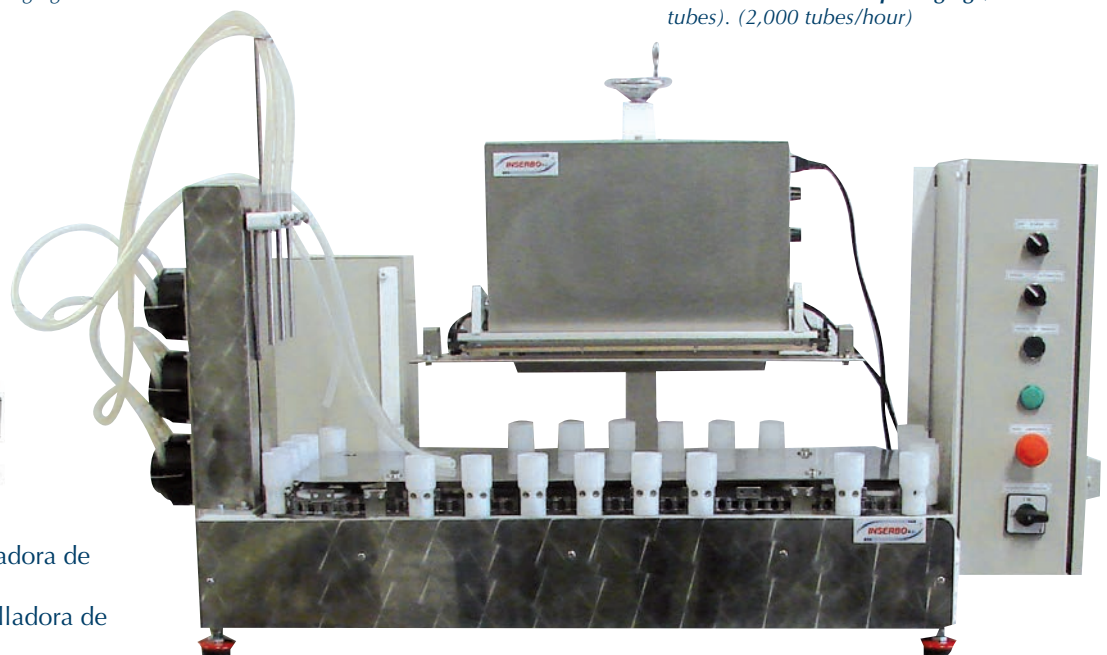

IA-281C Selladora-envasadora de tubos automática

IA-281C Automatic sealing/packaging machine for tubes



IA-354 Dispensador de portaobjetos

IA-354 Slide dispenser



Portaobjetos
Slides

IA-350 Paq. de 50 uds / Box of 50 U

IA-351 Paq. de 72 uds / Box of 72 U



IA-355A Cubreobjetos

18 x 18, alemán, paq. de 100 uds

IA-355A Slide covers 18 x 18, german model, box of 100 pcs



Cubreobjetos
Slide cover

IA-355 / IA-355A 18 x 18, paq. de 100 uds

IA-360 20 x 20, paq. de 100 uds

IA-362 22 x 22, paq. de 100 uds

IA-365 24 x 32, paq. de 100 uds

IA-355 / IA-355A 18 x 18. Box of 100 pcs

IA-360 20 x 20. Box of 100 pcs

IA-362 22 x 22. Box of 100 pcs

IA-365 24 x 32. Box of 100 pcs

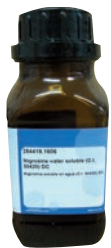

IA-375 Aceite de inmersión, frasco de 100 ml

IA-730 Nigrosina de 25 g

IA-735 Eosina para microscopía de 25 g

IA-725 Cafeína pura de 250 g

IA-375 Immersion oil, bottle of 100 ml

IA-730 Nigrosine, 25 g

IA-735 Eosine, 25 g

IA-725 Pure caffeine, 250 g



IA-380 Tolueno para la limpieza de las ópticas de los microscopios, frasco de 1 l

IA-380 Toluene, bottle of 1 l, to clean microscope accessories



IA-557 Varilla de vidrio para agitar

IA-557 Glass cane to shake

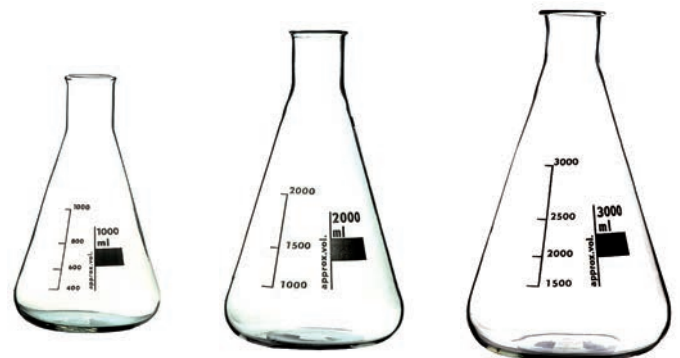

Erlenmeyer
Erlenmeyer

IA-504 500 ml

IA-505 1.000 ml

IA-510 2.000 ml

IA-515 3.000 ml

IA-517 5.000 ml

Material de laboratorio

Laboratory material

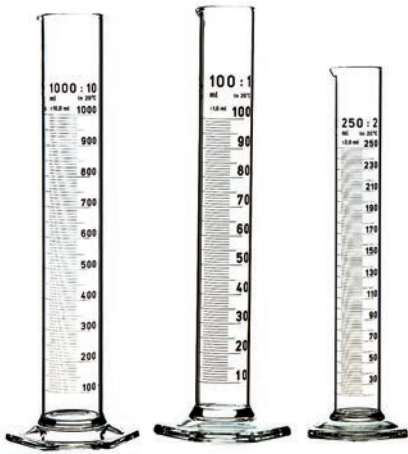

Probeta
Test tube

- IA-518A 25 ml
- IA-519 100 ml
- IA-520 250 ml
- IA-525 500 ml
- IA-530 1.000 ml
- IA-531 2.000 ml
- IA-531A 500 ml de plástico - *Plastic test tube*



IA-547 Botella de vidrio
con tapón de rosca y tubo
de salida, 5 l

*IA-547 Glass bottle with screw
cap and exhaust pipe (5 l)*



IA-545 Botella de vidrio con
tapón de rosca, 1.000 ml

*IA-545 Glass bottle with screw cap
(1,000 ml)*

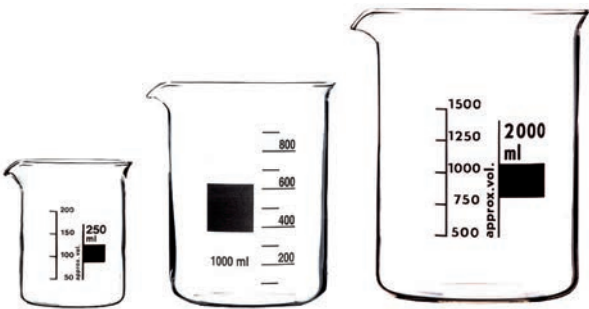

Vaso de precipitados
Beaker

- IA-535 250 ml F/B (L/F)
- IA-536 250 ml F/A (T/F)
- IA-539 400 ml F/A (T/F)
- IA-540 400 ml F/B (L/F)
- IA-541 1.000 ml F/B (L/F)
- IA-542 2.000 ml
- IA-543 3.000 ml
- IA-544 5.000 ml



IA-546 Botella de vidrio con tapón
de rosca, 250 ml

*IA-546 Glass bottle with screw cap (250
ml)*



Frasco lavador
Cleaning flask

- IA-550 1.000 ml
- IA-555 500 ml



IA-560 Botella de plástico con
tapón de rosca, 1.000 ml

IA-565 Botella de plástico con
tapón de rosca, 500 ml

*IA-560 Plastic bottle with screw cap
(1000 ml)*
*IA-565 Plastic bottle with screw cap
(500 ml)*

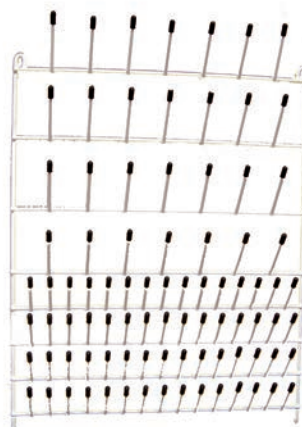

Escurreidor
Drainer

- IA-610A Con 44 terminales
- IA-610B Con 88 terminales

IA-610A with 44 terminals
IA-610B with 88 terminals



IA- 610C Escurreidor de
sobremesa y colgante, con 55
terminales

*IA-610C Table and hanging draining
board with 55 terminals*

Jarra de plástico
Plastic jar

- IA-566 500 ml
- IA-566A 1.000 ml
- IA-567 2.000 ml
- IA-569 3.000 ml
- IA-568 5.000 ml

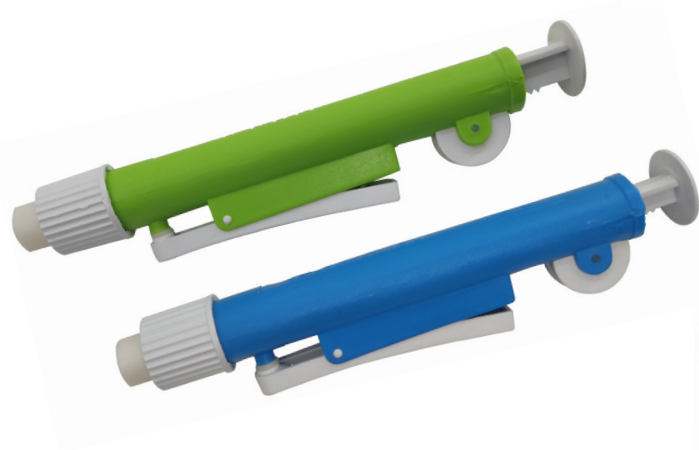

- IA-571 Aspirador para pipetas verde, de 2 a 10 ml
- IA-570 Aspirador para pipetas azul, 1 y 2 ml

- IA-571 Green aspirator for pipettes (2 ml to 10 ml)
- IA-570 Blue aspirator for pipettes (1 ml and 2 ml)



- IA-572/IA-572C/IA-572D Pipetas automáticas fijas: desde 10 microlitros hasta 1 ml
- IA-572A/IA-572B/IA-572E Pipetas automáticas graduables: desde 0,2-2 microlitros hasta 1-10 ml
- IA-573 Puntas micropipetas amarillas, de 5 a 200 ml, paq. 1.000 uds
- IA-574 Puntas micropipetas azules, de 100 a 1.000 ml, paq. 1.000 uds
- IA-572/IA-752C/IA-752D Fixed automatic pipettes: from 10 microliters to 1 ml
- IA-572A/IA-752B/IA-752E Adjustable automatic pipettes: from 0.2-2 microliters to 1-10 ml
- IA-573 Box of 1000 disposable yellow points for micropipette (5 to 200 ml)
- IA-574 Box of 1000 disposable blue points for micropipette (100 to 1,000 ml)



- IA-575 Pipeta aforada de 1 ml
- IA-576 Pipeta graduada de 1 ml
- IA-576A Pipeta graduada de 2 ml
- IA-577 Pipeta graduada de 5 ml
- IA-578 Pipeta graduada de 10 ml

- IA-575 Gage pipette (1 ml)
- IA-576 Graduated pipette (1 ml)
- IA-576A Graduated pipette (2 ml)
- IA-577 Graduated pipette (5 ml)
- IA-578 Graduated pipette (10 ml)



- IA-502 Pipetas Pasteur de plástico, paq. 500 uds
- IA-502A Pipetas Pasteur de plástico graduadas, paq. 500 uds

- IA-502 Plastic Pasteur pipettes, Box of 500 units
- IA-502A Graduated plastic Pasteur pipettes, Box of 500 units



- IA-500 Pipetas Pasteur de vidrio, cortas, paq. de 250 uds
- IA-501 Pipetas Pasteur de vidrio, largas, paq. de 250 uds

- IA-500 Short Pasteur pipettes, box of 250 units
- IA-501 Long Pasteur pipettes, box of 250 units

Material de laboratorio Laboratory material

**IA-580 Matraz
aforado de 100 ml**

**IA-580 Volumetric flask
(100 ml)**

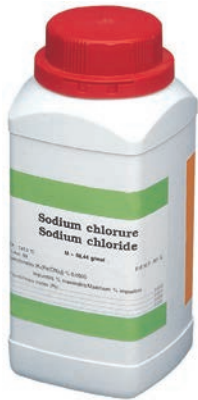

**IA-705 Cloruro
sódico de 1 kg**

**IA-705 Sodium
chloride (1 kg)**



**IA-711 Formaldehído,
frasco de 1.000 ml**

**IA-711 Formaldehyde, flask of
1,000 ml**



**IA-582 Fórmula
concentrada para 10
análisis de semen**

**IA-582 Concentrated
formula for 10 semen
tests**

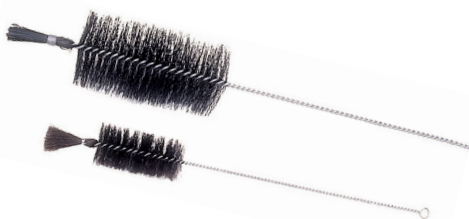

**Escobillón para limpiar material de vidrio
Brush to clean glass material**

**IA-590 pequeño
IA-595 grande
IA-589 mini
IA-589A mini corto**

**IA-590 Small
IA-595 big
IA-589 Mini
IA-589A Short mini**



Cámara de Burquer

**IA-585 Doble con pinzas
IA-587 Doble con pinzas, líneas
brillantes
IA-587A Doble sin pinzas, líneas
brillantes**

Bürker chamber

**IA-585 Double with clamps
IA-587 Double with clamps, bright lines
IA-587A Double without clamps, bright
lines**



**IA-370 Cubreobjetos para cámara de Burquer,
paq. de 10 uds**

IA-370 Slide covers for Bürker chamber, box of 10 units



**DS-415 Dosificador
de jabón y gel aut.
por infrarrojos**

**DS-415 Infrared
automatic soap and
gel dispenser**



**DS-420 Dosificador
de jabón manual**

**DS-420 Manual soap
dispenser**

Cámara de Neubauer

**IA-900 Doble con pinzas
IA-901 Doble sin pinzas**

Neubauer chamber

**IA-900 Double with clamps
IA-901 Double without clamps**



IA-588 Embudo de cristal

IA-588 Glass funnel



**Con PH neutro
para limpiar el
material de vidrio
With neutral PH
to clean the glass
material**

**IA-599 Detergente de laboratorio
GLASSGEN, 5 l**

IA-599 Laboratory detergent GLASSGEN 5 l



IA-624A Tapón con grifo para garrafa de agua bidestilada, 25 l

IA-624A Cap with exhaust pipe for bidistilled water decanter (25 l)

Agua bidestilada ultrapura
Ultrapure bidistilled water

- IA-623** 1 l
- IA-621** 5 l
- IA-624** 25 l



IA-623A Agua bidestilada ultrapura, Bag in Box de 25 l

IA-623A Ultrapure bidistilled water. Box of 25 l



IA-623B Agua bidestilada ultrapura con grifo, Bag in Box de 25 l

IA-623B Ultrapure bidistilled water with exhaust pipe. Box of 25 l



Material de laboratorio Laboratory material



IA-604 Gasas estériles para la extracción de semen, paq. de 100 uds (20 sobres de 5 uds)

IA-604 Sterile gauze for semen extraction, box of 100 units (20 bags of 5 pcs)



IA-607 Filtros para semen, paq. de 200 uds

IA-607 Semen filters, box of 200 pcs



IA-605 Termo para recogida de semen

IA-605 Thermal semen collection flask



IA-605A Termo para recogida de semen INSERBO

IA-605A INSERBO Thermal semen collection flask



IA-615 Diluyente para semen de 7 días MR-A

IA-615 MR-A semen extender (7 days)



IA-534A Vaso desechable liso sin tapa, 1 l

IA-534B Vaso desechable estriado sin tapa, 1 l

IA-534C Tapa para vaso desechable, 1 l

IA-534A Cup of 1l. Disposable smooth without lid

IA-534B Cup of 1l. Disposable striated without lid

IA-534C Disposable cup lid (1 l)



Vaso de plástico para extracción de semen
Plastic vessel for semen extraction

IA-532 Vaso con tapa

IA-533 Vaso sin tapa

IA-534 Tapa hermética

IA-532 Plastic vessel with lid

IA-533 Plastic vessel without lid

IA-534 Hermetic lid



IA-620 Diluyente para semen tipo BTS modificado

IA-620 BTS semen extender, modified type



IA-644 Colorante para semen, no espermicida

IA-644 Non-spermicidal colorant for semen



IA-605B Calentador recogida de semen de 6 vasos, a baterías

IA-605B Battery semen collection heater for 6 cups



IP-375 Guantes de látex libres de polvo (no espermicidas), paq. de 100 uds, varias tallas

IP-375 Dust-free latex gloves (non spermicide) 100 pcs package, several sizes



IP-135 Guantes de plástico desechables, paq. de 100 uds

IP-135 Disposable plastic gloves. 100 units package





IA-625E Toallitas “Biodegradables” para higiene de cerdas, no espermicida, cubo de 1.000 uds

IA-625A “Biodegradable” wet wipes for sows hygiene, bucket of 800 pcs (non spermicide)



IA-625A Toallitas desinfectantes para higiene de cerdas, no espermicida, cubo de 800 uds

IA-625A Disinfectant wet wipes for sows, bucket of 800 pcs (non spermicide)

TUBOS Y BOTELLAS CON SISTEMA ABREFÁCIL A.I. BOTTLES AND TUBES WITH EASY OPEN SYSTEM



IA-630 Botella dosis de semen completa de 100 ml, caja de 500 uds

IA-630 Complete dose semen bottles of 100 ml, box of 500 units



IA-632 Botella dosis blanda para semen con tapón de 100 ml, caja de 500 uds (tapón rojo, azul y verde)

IA-632 Soft dose bottles for semen 100 ml with cap, box of 500 units (red, blue and green cap)



IA-638 Tubos soldables extrafinos para dosis de semen INSERBO, 30 ml, caja de 2.000 uds

IA-638 INSERBO extra thin tube for semen doses, 30 ml, box of 2,000 pcs

Todos los modelos incluyen abre fácil
All models include easy open

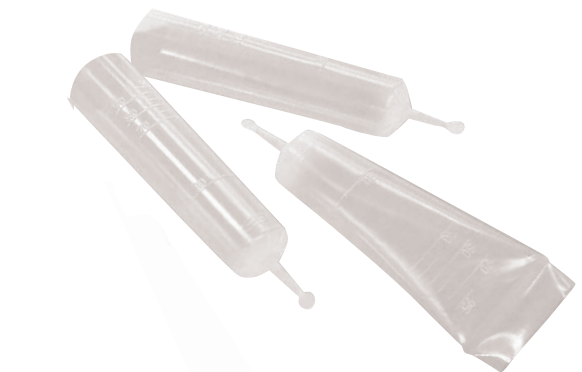

IA-637A Tubos soldables extrafinos para dosis de semen INSERBO, 95 ml, paq. de 1.500 uds

IA-637A INSERBO extra thin tube for semen doses, 95 ml, box of 1,500 pcs



IA-608C Adaptador de grifo para bolsa de I.A.

IA-608C Tap adaptor for bag IA-608B



Bolsas para I.A. para semen, paq. de 100 uds
A.I. bags for semen, box of 100 pcs

IA-608B Bolsas para semen con grifo y boquilla, 5 l

IA-608B Bags for semen with tap. 5 l

IA-608 5 l

IA-609 2 l

IA-608A 5 l, con troquel para colgar / with a hole to hang

CÁNULA POSTCERVICAL INSERBO

INSERBO INTRA-UTERINE CANNULA

Única en el mundo con 4 salidas
The only one with 4 holes

Multiposición

Más fácil, más rápido

¡Mejor!

Sin problemas de
posición

Multiposition

*easier, faster, better
avoids position problems*

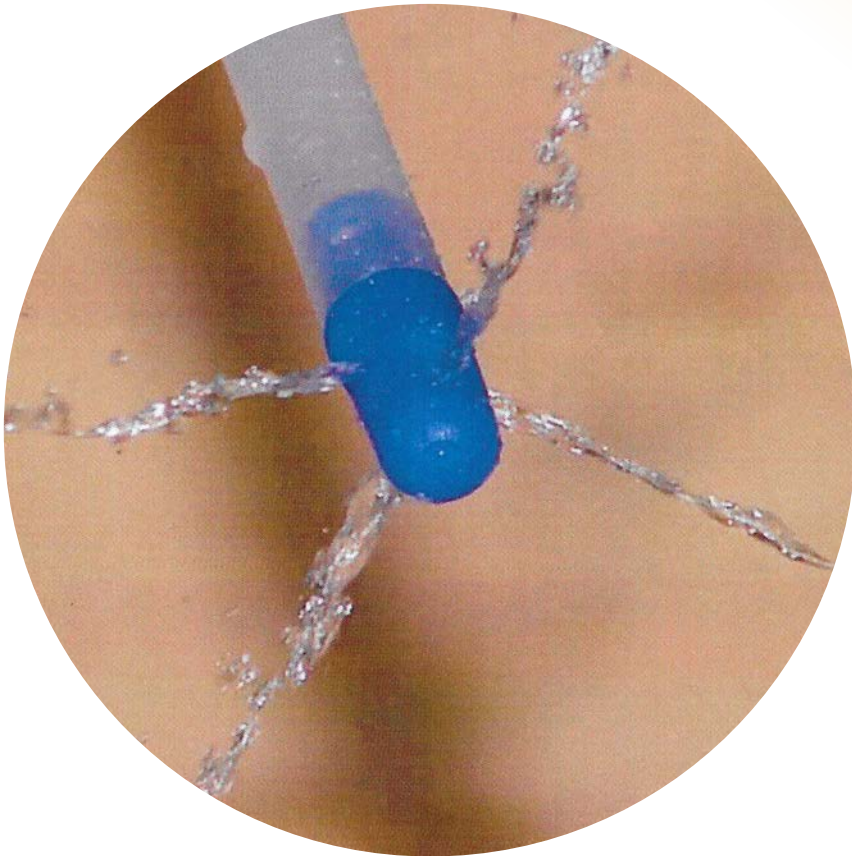

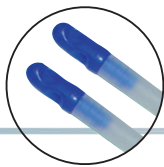

IA-485 Cánula postcervical INSERBO estéril para I.A., paq. de 2 uds

IA-485 INSERBO sterile A.I. *intra-uterine cannula*, bag of 2 pcs

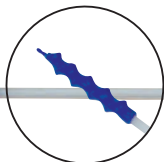

IA-492 Cánula postcervical INSERBO con catéter espiral azul paq. 1 u.

IA-492 INSERBO A.I. *intra-uterine cannula* with blue spiral catheter

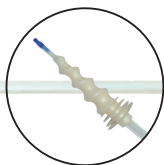

IA-490 Cánula postcervical INSERBO con catéter antirreflujo paq. 1 u.

IA-490 INSERBO *intra-uterine cannula* with antiflowing back catheter

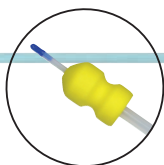

IA-495 Cánula postcervical INSERBO con catéter de esponja sin trasera paq. 1 u.

IA-495 *Intra-uterine cannula* with foam catheter

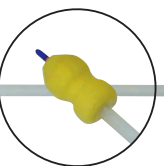

IA-498 Cánula postcervical INSERBO con catéter de esponja con trasera paq. 1 u.

IA-498 INSERBO *intra-uterine cannula* with foam catheter end part

Cánulas postcervicales con catéter

Intra-uterin cannulas with catheter



IA-478Y Cánula postcervical naranja, paq. de 5 uds

IA-478Y Orange *intra-uterine cannula*, bag of 5 pcs



IA-478C Cánula postcervical naranja con catéter azul, sin trasera, paq. de 5 uds

IA-478C Orange *intra-uterine cannula* with blue catheter without end part, bag of 5 pcs

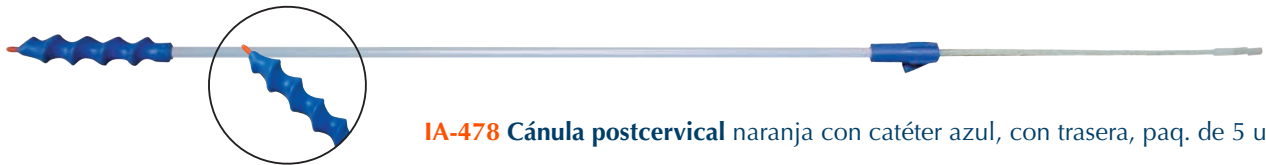

IA-478 Cánula postcervical naranja con catéter azul, con trasera, paq. de 5 uds

IA-478 Orange *intra-uterine cannula* with blue catheter with end part, bag of 5 pcs



IA-478B Cánula postcervical naranja con catéter antirreflujo

IA-478B Orange *intra-uterine cannula* with antirreflujo back catheter



IA-478A Cánula postcervical naranja con catéter de esponja, sin trasera, paq. de 5 uds

IA-478A Orange *intra-uterine cannula* with foam catheter without end part, bag of 5 pcs



IA-478D Cánula postcervical naranja con catéter de esponja, con trasera, paq. de 5 uds

IA-478D Orange *intra-uterine cannula* with foam catheter, with end part, bag of 5 pcs



IA-430 Catéter desechable antirreflujo INSERBO, paq. de 4 uds, caja de 1000 uds

IA-430 INSERBO *disposable catheter*, anti-flowing back, bag of 4 pcs, box of 1000 units



IA-470 Catéter desechable con tapón trasero INSERBO, paq. de 5 uds, caja de 500 uds

IA-470 INSERBO *disposable catheter* with end part, bag of 5 pcs, box of 500 units



IA-475 Catéter desechable naranja INSERBO, paq. de 5 uds, caja de 500 uds

IA-475 INSERBO orange *disposable catheter*, bag of 5 pcs, box of 500 units



IA-477 Catéter desechable espiral azul, con tapón trasero, paq. de 5 uds, caja de 500 uds

IA-477 Blue spiral *disposable catheter*, bag of 5 pcs, box of 500 units



IA-405 Catéter de caucho nacional tipo melrouse

IA-405 Melrouse type national *rubber catheter*

Catéteres / Gel lubricante

Catheters / Lubricant gel



IA-468 Catéter **desechable** tipo esponja para nulíparas con tapón trasero, paq. de 5 uds, caja de 500 u

IA-468 Foam **disposable catheter** with end part, for gilts, bag of 5 pcs, box of 500 pcs



IA-469 Catéter **desechable** tipo esponja para nulíparas sin trasera paq. 5 u, caja de 500 u

IA-469 Foam **disposable catheter** without end part, for gilts, bag of 5 pcs, box of 500 pcs



Catéter desechable tipo esponja INSERBO, caja de 500 u

INSERBO foam **disposable catheter**, box of 500 pcs

IA-462 Envasado, paq. de 1

IA-462 1pcs/bag

IA-464 Envasado, paq. de 5 uds

IA-464 5 pcs/bag

IA-464B Envasado, paq. de 25 uds

IA-464B 25 pcs/bag



Catéter desechable tipo esponja con tapón trasero INSERBO, caja de 500 u

INSERBO foam **disposable catheter** with end part, box of 500 pcs

IA-467 Envasado paq. 1 u

IA-467 1pcs/bag

IA-465 Envasado, paq. de 5 uds

IA-465 5 pcs/bag

IA-467B Envasado, paq. de 25 uds

IA-467B 25 pcs/bag



Adaptador-Alargo para catéteres

Adapter-Estensiom for catheters

IA-480 Paquete de 200 unidades

IA-480 Pack of 200 units

IA-481 Paquete de 5 unidades

IA-481 Pack of 5 units



IA-775 / IA-780 Gel lubricante-desinfectante ginecológico no espermicida de 1 y 5 l

IA-775 / IA-780 Disinfectant-lubricant gynecological gel (1 and 5 l) (no spermicide)



IA-699 Vaselina líquida de 1 l
IA-699 Liquid vaseline (1 l)

IA-698A Vaselina líquida de 5 l
IA-698A Liquid vaseline (5 l)

Spray para detectar celo en cerdas
Spray to detect heat in sows

IA-612 80 ml
IA-612A 250 ml



IA-611B Alforja para inseminación artificial "manos libres" INSERBO

IA-611B INSERBO hands free holder for artificial insemination



IA-640 Cúter para abrir botellas y tubos de inseminación artificial

IA-640 Cutter to open artificial insemination bottles and tubes



IA-641 Etiquetadora para dosis de semen

IA-641 Labelling machine for semen samples

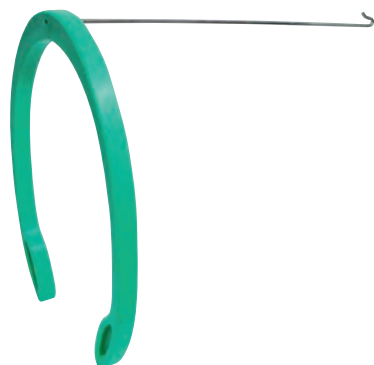

IA-611C Arco para inseminación de cerdas múltiparas, verde

IA-611C Green A.I. buddy for sows



IA-611D Arco para inseminación de cerdas nulíparas, amarillo

IA-611D Yellow A.I. buddy for gilts

Alfombras / Carro inseminación / Botes

Rugs / A.I. trolleys / Bottles

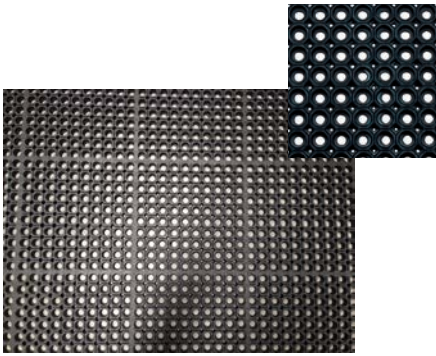

IA-675 Alfombra antiresbalante para sala de montar, 150 x 100 cm

IA-675A Alfombra antiresbalante para sala de montar extra, 152 x 91 cm

IA-675 Antislippery alveolar rug for mating room (150 x 100 cm)

IA-675A Antislippery alveolar rug for mating room (152 m x 91 cm)



IA-676 Alfombra círculos negros, rollo de 10 m x 1,5 m x 3 mm

IA-676 Black circles rug 10 m roll 1.5 m x 3 mm



IA-828 Levamix Nucleus, 5 kg.

IA-828 Nucleus Levamix, 5 kg



Apoyo desmontable / Detachable support

IA-670 Potro para monta fijo y móvil (madera forrada) con apoyo

IA-670 Mating table, wood lined, fixed and mobile with support



IA-680 Rollo de papel para laboratorios "grande" (celulosa pura)

IA-685 Portarrollos de papel Inox de sobremesa y colgante.

IA-680 Laboratory paper roll "big" (pure cellulose)

IA-685 Stainless steel table and hanging paper roll carrier



IA-686 Portarrollos de papel de pie fijo

IA-686 Fixed paper roll carrier



IA-679 Rollo de papel para laboratorios "pequeño" (celulosa pura)

IA-679 Laboratory paper roll "small" (pure cellulose)

IA-668A Carro-mesa para inseminación artificial Inox. De simple manejo, estrecho, práctico y de fácil maniobrabilidad. Puede adaptarse al baño maría y calentador de dosis de semen de la página 183

IA-668A Trolley for artificial insemination. Easy to handle convenient and narrow. Adjustable to water bath and semen heater Ref. IA-202, IA-203 (page 165).

No incluye accesorios, catéteres, etc.
Accessories not included



JG-590 Placa de Petri, 55 x 14 mm

JG-590 Petri plate, 55x14mm.



JG-582A Botella esteril con tiosulfato para análisis de agua, de 1.000 ml

JG-582A Sterile bottle with thiosulfate for water analysis, 1,000 ml



JG-580 Bote para recogida de muestras, 2.000 ml

JG-580 Samples collecting pot, 2,000 ml



Botella con goma y tapón
Bottle with rubber and top

- AG-292** 100 ml
- AG-293** 250 ml
- AG-294** 500 ml
- AG-295** 1.000 ml



AG-296 Tapón de goma para botella de 250, 500 y 1000 ml

AG-297 Rubber stopper for 250, 500 and 1000 ml



AG-297 Tapón de plástico abierto para botella de 250, 500 y 1000 ml

AG-297 Open plastic cap for 250, 500 and 1000 ml



Bote para recogida de muestras
Samples collecting pot

- JG-569** 40 ml
- JG-570** 100 ml
- JG-571** estéril, 100 ml

JG-569 40 ml
JG-570 100 ml
JG-571 100 ml sterile



Tarro de boca ancha con tapa y obturador
Wide mouth with tap and shutter

- JG-584** 1.000 ml
- JG-585** 500 ml
- JG-586** 250 ml



JG-578 Bote 30 ml con tapón de seguridad

JG-578 30 ml pot with safety cap



**REGULABLE
ADJUSTABLE**



AG-299E Pistola pulverizadora profesional (Sin botella)

AG-299E Professional spray gun (Without bottle)

AG-299D Botella con pulverizador de 750ml (alta calidad)

AG-299D 750 ml spray bottle (high quality)



JG-540A Tubos vacios, 5 ml con etiqueta y tapón verde, paq. de 1000 uds

JG-540B Tubos vacios, 10 ml con etiqueta y tapón verde, paq. de 500 uds

JG-540A Empty tubes, 5 ml with label and green cap, box of 1000 pcs

JG-540B Empty tubes, 10 ml with label and green cap, box of 500 pcs



JG-505 MONOVETTE L suero de 9 ml, caja 50 uds

JG-505 MONOVETTE L serum 9 ml, box 50 units



JG-540 Tubo vacios, 5 ml, paq. de 100 uds

JG-541 Tubo presuero, 5 ml, paq. de 100 uds

JG-540 Serum tubes, 5 ml, box of 100 pcs

JG-541 Empty tubes, 5 ml, box of 100 pcs



JG-575 Tubo para muestras de 13 ml, paq. de 100 uds

JG-575 Samples collecting tube, 13 ml, 100 units package

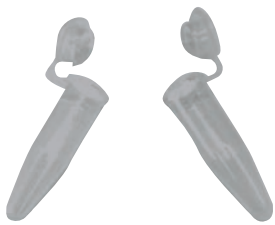

JG-595 Microtubos EPPENDORF, 1,5 ml, paq. 1.000 uds

JG-595 EPPENDORF microtube, 1.5 ml, pack of 1,000 units



JG-536 Tubo para muestras de 5 ml, paq. 1.000 uds

JG-536 5 ml sample tube, pack of 1,000 units



JG-535 Tubo para muestras de 5 ml, con tapón (separado), paq. 2.000 uds

JG-535 5 ml sample tube, with stopper (separate), pack of 2,000 units



IO-164 Hisopo veterinario LARYNGEAL extralargo 27 cm, paq. 100

IO-164 LARYNGEAL extra large veterinary swab 27 cm. Bag with 100 pcs



IO-160 Hisopo estéril de 15 cm para recogida de muestras (con medio de cultivo)

IO-161 Hisopo estéril de 15 cm para recogida de muestras (sin medio de cultivo)

IO-160 Sterile swab (15 cm) to obtain samples (With transport medium)

IO-161 Sterile swab (15 cm) to obtain samples (Without transport medium)



JG-567 Cuerda natural para recolección fluidos naturales

JG-567 Natural rope for collecting natural fluids



JG-568 Kit de recolección de fluidos orales para cerdos

JG-568 Oral fluid collection and testing kit for pigs



IA-909 Gradilla de aluminio en forma de Z para 50 tubos, hasta 17 mm Ø

IA-909 Aluminium tube-rack; Z form, for 50 tubes, up to 17 mm Ø

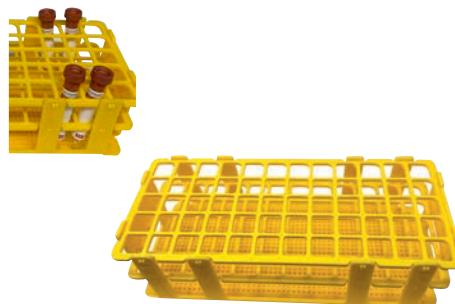

IA-911 Gradilla de plástico para 60 tubos, hasta 16 mm Ø

IA-911 Plastic tube-rack for 60 tubes, up to 16 mm Ø



IA-912 Gradilla de plástico para 21 tubos, hasta 30 mm Ø

IA-912 Plastic tube-rack for 21 tubes, up to 30 mm Ø

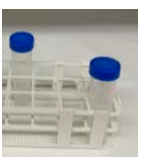

Extracción de sangre Blood collection



- JG-563** Aguja VACUTAINER 38 x 1,2, paq. de 100 uds
- JG-564** Aguja VACUTAINER 25 x 1,2, paq. de 100 uds
- JG-562** Aguja VACUTAINER 25 x 0,9, paq. de 100 uds

- JG-563** VACUTAINER needles 38G x 1 1/2", box of 100 pcs
- JG-564** VACUTAINER needles 25G x 1", box of 100 pcs
- JG-562** VACUTAINER needles 25G x 0.9", box of 100 pcs



- JG-558** Aguja VACUETTE 38 x 1,2, paq. de 100 uds
- JG-559** Aguja VACUETTE 25 x 1,2, paq. de 100 uds

- JG-558** VACUETTE needles 38G x 1 1/2", box of 100 pcs
- JG-559** VACUETTE needles 25G x 1", box of 100 pcs



- JG-565** Adaptador para tubos VACUTAINER cuadrado
- JG-566** Adaptador para tubos VACUTAINER redondo
- JG-566A** Adaptador para tubos VACUETTE

- JG-565** Adapter for VACUTAINER tubes, square
- JG-566** Adapter for VACUTAINER tubes, round
- JG-566A** Adapter for VACUETTE tubes



- JG-546** Tubos VACUETTE plástico de 4,5 ml, paq. 50 uds
- JG-546C** Tubos VACUETTE 4,5 ml, "con código de barras" paq. 50 uds

- JG-546** VACUETTE plastic tubes 4.5 ml, box of 50 pcs
- JG-546C** VACUETTE tubes 4.5 ml, "with barcode" box of 50 pcs



- JG-545** Tubos VACUTAINER de 5 ml, paq. de 40 uds
- JG-545** VACUTAINER tubes 5 ml, box of 40 pcs



- JG-545A** Tubos VACUTAINER con EDTA de 4 ml, 10 paq. de 100 uds
- JG-545A** VACUETTE tubes with EDTA.4 ml, 10 pack of 100 units



Medidores de humedad

Humidity tester



DG-180 Medidor de humedad para paja y heno con lanza, 50 cm

JG-180 Moisture meter for straw and hay with lance, 50 cm



DG-185 Medidor de temperatura Inox para grano con lanza, 280 cm

DG-185 Stainless steel temperature gauge for grain with lance, 280 cm

DG-175 Medidor de humedad para grano

DG-175 Moisture meter for grain





www.inserbo.com
Tel: +34 973 75 03 13 Fax: +34 973 75 17 72
Pol. Industrial Torrefarrera C/ Ponent, nº 3
25123 TORREFARRERA (LLEIDA) SPAIN
inserbo@inserbo.com

INSERFIX®

STARVET®

STARVET®
forte

GLASSGEN®

FUTURE-1®

SERBONET®

GROTEERMAN®

investigación
investigation



INSERBO S.L.



Tel.: +34 973 75 03 13 Fax: +34 973 75 17 72 Pol. Industrial Torrefarrera
C/ Ponent, nº 3 | 25123 TORREFARRERA (LLEIDA) SPAIN
inserbo@inserbo.com